

Intel[®] 413808 and 413812 SAS/ SATA I/O Controllers

Thermal Design Considerations Application Note

July 2007



INFORMATION IN THIS DOCUMENT IS PROVIDED IN CONNECTION WITH INTEL® PRODUCTS. NO LICENSE, EXPRESS OR IMPLIED, BY ESTOPPEL OR OTHERWISE, TO ANY INTELLECTUAL PROPERTY RIGHTS IS GRANTED BY THIS DOCUMENT. EXCEPT AS PROVIDED IN INTEL'S TERMS AND CONDITIONS OF SALE FOR SUCH PRODUCTS, INTEL ASSUMES NO LIABILITY WHATSOEVER, AND INTEL DISCLAIMS ANY EXPRESS OR IMPLIED WARRANTY, RELATING TO SALE AND/OR USE OF INTEL PRODUCTS INCLUDING LIABILITY OR WARRANTIES RELATING TO FITNESS FOR A PARTICULAR PURPOSE, MERCHANTABILITY, OR INFRINGEMENT OF ANY PATENT, COPYRIGHT OR OTHER INTELLECTUAL PROPERTY RIGHT. Intel products are not intended for use in medical, life saving, life sustaining, critical control or safety systems, or in nuclear facility applications.

Intel may make changes to specifications and product descriptions at any time, without notice.

Intel Corporation may have patents or pending patent applications, trademarks, copyrights, or other intellectual property rights that relate to the presented subject matter. The furnishing of documents and other materials and information does not provide any license, express or implied, by estoppel or otherwise, to any such patents, trademarks, copyrights, or other intellectual property rights.

Designers must not rely on the absence or characteristics of any features or instructions marked "reserved" or "undefined." Intel reserves these for future definition and shall have no responsibility whatsoever for conflicts or incompatibilities arising from future changes to them.

Intel processor numbers are not a measure of performance. Processor numbers differentiate features within each processor family, not across different processor families. See http://www.intel.com/products/processor_number for details.

The Intel® 413808 and 413812 SAS/SATA I/O controllers may contain design defects or errors known as errata which may cause the product to deviate from published specifications. Current characterized errata are available on request.

Hyper-Threading Technology requires a computer system with an Intel® Pentium® 4 processor supporting HT Technology and a HT Technology enabled chipset, BIOS and operating system. Performance will vary depending on the specific hardware and software you use. See http://www.intel.com/products/ht/Hyperthreading_more.htm for additional information.

Contact your local Intel sales office or your distributor to obtain the latest specifications and before placing your product order.

Copies of documents which have an order number and are referenced in this document, or other Intel literature may be obtained by calling 1-800-548-4725 or by visiting Intel's website at <http://www.intel.com>.

BunnyPeople, Celeron, Celeron Inside, Centrino, Centrino logo, Core Inside, Dialogic, FlashFile, i960, InstantIP, Intel, Intel logo, Intel386, Intel486, Intel740, IntelDX2, IntelDX4, IntelSX2, Intel Core, Intel Inside, Intel Inside logo, Intel. Leap ahead., Intel. Leap ahead. logo, Intel NetBurst, Intel NetMerge, Intel NetStructure, Intel SingleDriver, Intel SpeedStep, Intel StrataFlash, Intel Viiv, Intel vPro, Intel XScale, IPLink, Itanium, Itanium Inside, MCS, MMX, Oplus, OverDrive, PDCharm, Pentium, Pentium Inside, skool, Sound Mark, The Journey Inside, VTune, Xeon, and Xeon Inside are trademarks or registered trademarks of Intel Corporation or its subsidiaries in the United States and other countries.

The ARM* and ARM Powered logo marks (the ARM marks) are trademarks of ARM, Ltd., and Intel uses these marks under license from ARM, Ltd.

*Other names and brands may be claimed as the property of others.

Copyright © 2007, Intel Corporation. All Rights Reserved.



Contents

1.0 Intel® 413808 and 413812 SAS/SATA I/O Controllers Introduction	7
1.1 Reference Documents and Information Sources	7
1.2 Product Package Thermal Specification	7
1.3 Intended Audience	7
1.4 Measuring the Thermal Conditions	8
1.5 Thermal Considerations	8
1.6 Importance of Thermal Management	8
1.7 What is in This Document	9
2.0 Packaging Terminology	10
3.0 Thermal Specifications	11
3.1 Case Temperature	11
3.2 Designing for Thermal Performance	11
4.0 Thermal Attributes	12
4.1 Typical System Definitions	12
4.2 Intel® 413808 and 413812 SAS/SATA I/O controllers Thermal Attributes	13
4.2.1 Intel® 413808 and 413812 SAS/SATA I/O controllers Package Mechanical Attributes	13
4.2.2 Intel® 413808 and 413812 SAS/SATA I/O controllers Package Thermal Characteristics	14
5.0 Thermal Enhancements	15
5.1 Clearances	15
5.2 Default Enhanced Thermal Solution	17
5.3 Extruded Heat Sinks	18
5.4 Attaching the Extruded Heat sink	20
5.4.1 Clips	20
5.4.2 Thermal Interface Material (PCM45F)	20
5.5 Reliability	22
5.6 Thermal Interface Management for Heat-Sink Solutions	23
5.6.1 Bond Line Management	23
5.6.2 Interface Material Performance	23
5.6.2.1 Thermal Resistance of the Material	23
5.6.2.2 Wetting/Filling Characteristics of the Material	23
6.0 Measurements for Thermal Specifications	24
6.1 Case Temperature Measurements	24
6.1.1 Attaching the Thermocouple (Heat Sink)	25
7.0 Thermal Diode	26
8.0 Conclusion	27
A Heat Sink and Attach Suppliers	28
B PCB Guidelines	28



Figures

1	Intel® 413808 and 413812 SAS/SATA I/O controllers 37.5mm 1357 FCBGA Mechanical Drawing	13
2	Maximum Allowable Ambient Temperature vs. Air Flow	14
3	Intel® 413808 and 413812 SAS/SATA I/O controllers Heat Sink Keep-out Restriction	16
4	Intel® 413808 and 413812 SAS/SATA I/O controllers Extruded Heat sink (reference only) .	19
5	PCM45F Attach Process (in roll formal)	21
6	Completing the Attach Process	21
7	Technique for Measuring Tcase with 90° Angle Attachment	25



Tables

1	Reference Documents and Information Sources.....	7
2	Package Thermal Characteristics in Standard JEDEC Environment.....	7
3	Intel® 413808 and 413812 SAS/SATA I/O Controllers Thermal Absolute Maximum Rating .	11
4	Expected Tcase (°C) for heat sink (40x40x18mm) attached at TDP.....	14
5	Reliability Validation	22
6	Thermal Diode Parameters	26
7	Thermal Diode Interface	26
8	Heat Sink and Attach Suppliers	28



Revision History

Date	Revision	Description
July 2007	002	Thermal Design Power (TDP) Update.
September 2006	001	Launch Release.



1.0 Intel® 413808 and 413812 SAS/SATA I/O Controllers Introduction

This document describes the Intel® 413808 and 413812 SAS/SATA I/O controllers with Intel XScale® technology¹ (413808 and 413812). The 413808 and 413812 have High and Low End thermal characteristics and suggested thermal solutions. All these parts are referred to as 413808 and 413812 hereafter as the same thermal solution applies to all these parts. Properly designed solutions provide adequate cooling to maintain the 413808 and 413812 case temperature (Tcase) at or below those listed in Table 2. Ideally, this is accomplished by providing a low local ambient temperature and creating a minimal thermal resistance to that local ambient temperature. Heat sinks may be required when case temperatures exceed those listed in Table 2. By maintaining the 413808 and 413812 case temperature at or below those recommended in this document, the 413808 and 413812 functions properly and reliably.

1.1 Reference Documents and Information Sources

Table 1. Reference Documents and Information Sources

Document Name or Information Source	Available Form
Integrated Circuit Thermal Measurement Method-Electrical Test Method	EIA/JESD51-1
Integrated Circuits Thermal Test Method Environmental Conditions - Natural Convection (Still Air)	EIAJESD51-2

1.2 Product Package Thermal Specification

Table 2. Package Thermal Characteristics in Standard JEDEC Environment

Package Type	ΦJA	ΦJT
37.5 mm, 1357 balls FCBGA IHS ¹	8.11°C/W ²	0.23°C/W
37.5 mm, 1357 balls FCBGA IHS-Heat Sink	6.48°C/W ³	0.23°C/W

1. IHS - Integrated Heat Spreader.
2. Integrated Circuit Thermal Measurement Method - Electrical Test Method EIA/JESD51-1, Integrated Circuit Thermal Test Method Environmental Conditions - Natural Convection (still air), no heat sink attached EIA/JESD51-2.
3. Natural convection (still air), heat sink attached.

Thermal parameters defined above are based on simulated results of packages assembled on standard multilayer 2s2p 1.0-oz Cu layer boards, in a natural convection environment.

Note: Thermal models are available upon request (Flotherm 2-Resistor, Delphi or Detailed format).

1.3 Intended Audience

The intended audience for this document is System Design Engineers using the 413808 and 413812. System designers are required to address component and system-level thermal challenges as the market continues to adopt products with higher-speeds and port densities. New designs may be required to provide better cooling solutions for silicon devices depending on the type of system and target operating environment.

1. ARM* architecture compliant.



1.4 Measuring the Thermal Conditions

This document provides a method for determining the operating temperature of the 413808 and 413812 in a specific system, based on case temperature. Case temperature is a function of the local ambient and internal temperatures of the component. This document specifies a maximum allowable T_{case} for the 413808 and 413812.

1.5 Thermal Considerations

Component temperature in a system environment is a function of the component, board, and system thermal characteristics. The board/system-level thermal constraints consist of the following:

- Local ambient temperature near the component.
- Airflow over the component and surrounding board.
- Physical constraints at, above, and surrounding the component that may limit the size of a thermal enhancement.

The component die temperature depends on the following:

- Component power dissipation.
- Size.
- Packaging materials (effective thermal conductivity).
- Type of interconnection to the substrate and motherboard.
- Presence of a thermal cooling solution.
- Thermal conductivity.
- Power density of the substrate/package, nearby components, and circuit board to which it is attached.

Technology trends continue to push these parameters toward increased performance levels (higher operating speeds), I/O density (smaller packages), and silicon density (more transistors). Power density increases and thermal cooling solution space and airflow become more constrained as operating frequencies increase and packaging sizes decrease. These issues result in an increased emphasis on the following:

- Package and thermal enhancement technology to remove heat from the device.
- System design to reduce local ambient temperatures and ensure that thermal design requirements are met for each component in the system.

1.6 Importance of Thermal Management

The thermal management objective is to ensure that all system component temperatures are maintained within functional limits. The functional temperature limit is the range in which the electrical circuits are expected to meet specified performance requirements. Operation outside the functional limit can degrade system performance, cause logic errors, or cause component and/or system damage. Temperatures exceeding the maximum operating limits may result in irreversible changes in the component operating characteristics.



1.7 What is in This Document

This document contains the following sections:

[Section 2.0, "Packaging Terminology" on page 10](#), provides definitions for package terminology used in this document.

[Section 3.0, "Thermal Specifications" on page 11](#), provides 413808 and 413812 case temperature specifications and where to find power requirements. This section also discusses thermal packaging techniques

[Section 4.0, "Thermal Attributes" on page 12](#), provides 413808 and 413812 thermal characteristic data, package mechanical attributes, and package thermal characteristic data. Use this section to determine your thermal solution requirements.

[Section 5.0, "Thermal Enhancements" on page 15](#), (If Required) discusses the use of heat sinks, fan sink, heat sink attach methods, heat sink interfacing, and heat sink reliability.

[Section 6.0, "Measurements for Thermal Specifications" on page 24](#), provides instructions for measuring 413808 and 413812 case temperature with a heat sink and fan sink.

[Section 7.0, "Thermal Diode" on page 26](#), discusses Thermal Die promontories and interface.

[Section 8.0, "Conclusion" on page 27](#).



2.0 Packaging Terminology

The following is a list of packaging terminology used in this document:

FCBGA Flip Chip Ball Grid Array:

A surface mount package using a combination of flip chip and BGA structure whose PCB-interconnect method consists of Pb-free ball array on the interconnect side of the package. The die is flipped and connected to an organic build-up substrate with C4 bumps. An integrated heat spreader may be present for larger FCBGA packages for enhanced thermal performance.

Junction:

Refers to a P-N junction on the silicon. In this document, it is used as a temperature reference point (for example, Theta JA refers to the “junction” to ambient temperature).

Ambient:

Refers to local ambient temperature of the bulk air approaching the component. It can be measure by placing a thermocouple approximately 1-inch upstream from the component edge.

Lands:

The pads on the PCB to which BGA Balls are soldered.

PCB:

Printed Circuit Board.

Printed Circuit Assembly (PCA):

An assembled PCB.

Thermal Design Power (TDP):

The estimated maximum possible/expected power generated in a component by a realistic application.

LFM:

Linear Feet per Minute (airflow).



3.0 Thermal Specifications

To ensure proper operation and reliability of the 413808 and 413812, the thermal solution must maintain a case temperature at or below the values specified in [Table 3](#). System-level or component-level thermal enhancements are required to dissipate the generated heat, when the case temperature exceeds the maximum temperatures listed in [Table 3](#).

Analysis indicates that real applications are unlikely to cause the 413808 and 413812 product line to be at Tcase-max for sustained periods of time. Given that Tcase should reasonably be expected to be a distribution of temperatures, sustained operation at Tcase-max may affect long-term reliability of the 413808 and 413812 product line and the system, and sustained performance at Tcase-max should be evaluated during the thermal design process and steps taken to further reduce the Tcase temperature.

Good system airflow is critical to dissipate the highest possible thermal power. The size and number of fans, vents, and/or ducts, and, their placement in relation to components and airflow channels within the system determine airflow. Acoustic noise constraints may limit the size and types of fans, vents and ducts that can be used in a particular design.

To develop a reliable, cost-effective thermal solution, all of the system variables must be considered. Use system-level thermal characteristics and simulations to account for individual component thermal requirements.

Table 3. Intel® 413808 and 413812 SAS/SATA I/O Controllers Thermal Absolute Maximum Rating

Core Frequency	Estimated TDP (W)	Tcase Max-hs ¹ (C) ²
800 MHz	9.88	100
1200 MHz	11.21	100

1. Tcase Max-hs is defined as the maximum case temperature with the Default Enhanced Thermal Solution attached.
2. This is not to exceed maximum allowable case temperature.

The thermal parameters defined above are based on simulated results of packages assembled on standard multi-layer 2s2p 1.0-oz Cu layer boards in a natural convection environment. The maximum case temperature is based on the maximum junction temperature and defined by the relationship, $T_{case-max} = T_{jmax} - (\Phi_{JT} \times Power)$ where Φ_{JT} is the junction-to-package top thermal characterization parameter. When the case temperature exceeds the specified Tcase max, thermal enhancements such as heat sinks or forced air are required. Φ_{JA} is the package junction-to-air thermal resistance.

3.1 Case Temperature

The 413808 and 413812 is designed to operate properly as long as the Tcase is not exceeded. [Section 6.1, "Case Temperature Measurements" on page 24](#) discusses proper guidelines for measuring the case temperature.

3.2 Designing for Thermal Performance

[Appendix B, "PCB Guidelines"](#) documents the PCB and system design recommendations required to achieve the 413808 and 413812 thermal performance documented herein.



4.0 Thermal Attributes

4.1 Typical System Definitions

The following system example is used to generate thermal characteristics data:

- The heat sink case assumes the default enhanced thermal solution (see [Section 5.3, "Extruded Heat Sinks" on page 18](#)).
- The evaluation board is a four-layer, 4 x 4.5" PCB.
- All data is preliminary and is not validated against physical samples.
- Your system design may be significantly different.
- A larger board size with more than six Cu layers may increase the 413808 and 413812 thermal performance.



4.2 Intel® 413808 and 413812 SAS/SATA I/O controllers Thermal Attributes

4.2.1 Intel® 413808 and 413812 SAS/SATA I/O controllers Package Mechanical Attributes

The 413808 and 413812 is packaged in a 37.5 mm, 1357 ball FCBGA. The mechanical drawing is shown in Figure 1.

Figure 1. Intel® 413808 and 413812 SAS/SATA I/O controllers 37.5mm 1357 FCBGA Mechanical Drawing

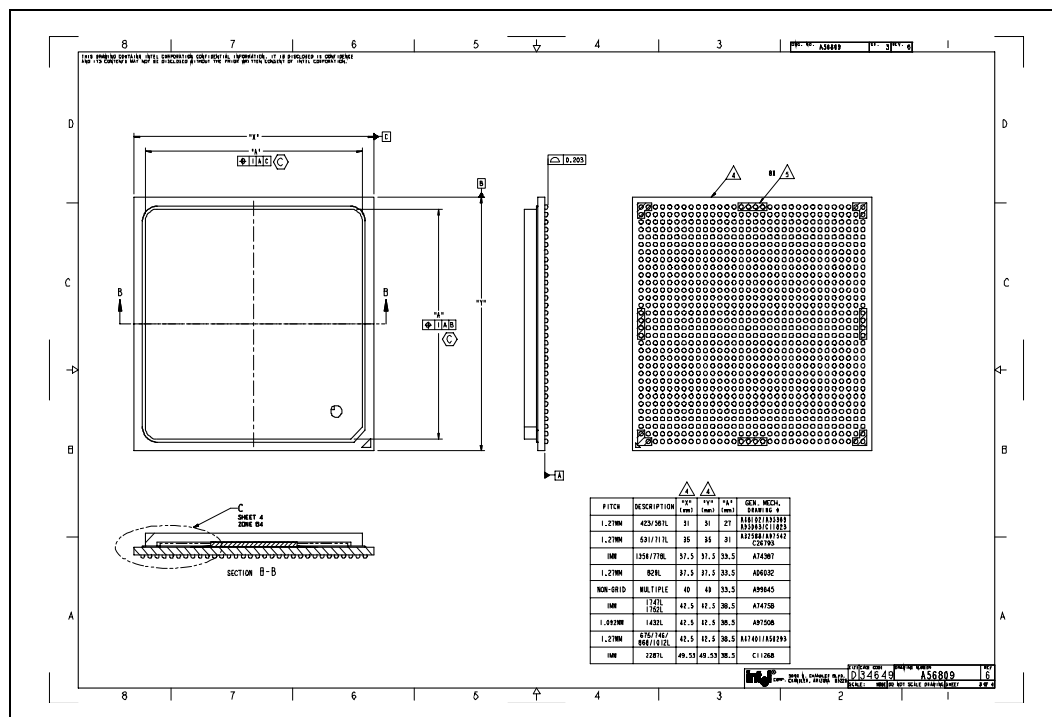



4.2.2 Intel® 413808 and 413812 SAS/SATA I/O controllers Package Thermal Characteristics

Figure 2 shows the required local ambient temperature versus airflow for a typical 413808 and 413812 system (see Section 4.1, "Typical System Definitions" on page 12 for a typical system definition).

Figure 2. Maximum Allowable Ambient Temperature vs. Air Flow

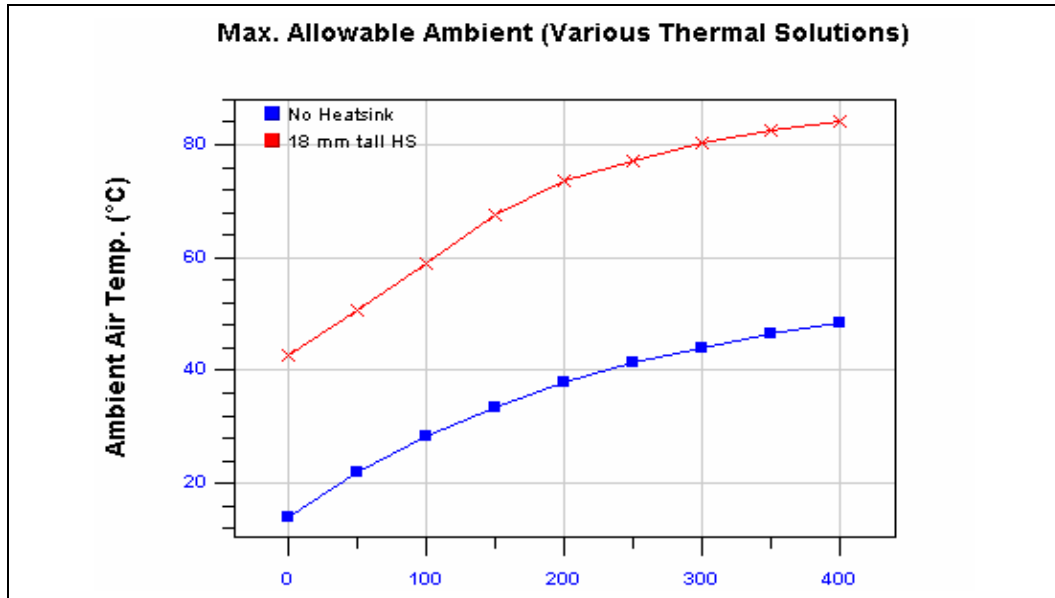

Table 4 show Tcase as a function of airflow and ambient temperature at the TDP for a typical 413808 and 413812 system and aids in determining the optimum airflow and heat sink combination for the device.

Table 4. Expected Tcase (°C) for heat sink (40x40x18mm) attached at TDP

70 °C amb.	<u>130</u>	<u>122</u>	<u>114</u>	<u>105</u>	99	95	92	90	89
65 °C amb.	<u>125</u>	<u>117</u>	<u>109</u>	100	94	90	87	85	84
60 °C amb.	<u>120</u>	<u>112</u>	<u>104</u>	95	89	85	82	80	79
55 °C amb.	<u>115</u>	<u>107</u>	99	90	84	80	77	75	74
50 °C amb.	<u>110</u>	<u>102</u>	94	85	79	75	72	70	69
45 °C amb.	<u>105</u>	97	89	80	74	70	67	65	64
40 °C amb.	100	92	84	75	69	65	62	60	59
35 °C amb.	95	87	79	70	64	60	57	55	54
30 °C amb.	90	82	74	65	59	55	52	50	49
AirFlow (LFM)	0	50	100	150	200	250	300	350	400

Note: System design may vary considerably from the typical system board environment used to generate Table 4.

Note: Thermal models are available upon request (Flotherm: 2-Resistor, Delphi, or Detailed). Contact your local Intel sales representative if you would like to receive 413808 and 413812 thermal models.

Note: The underlined value(s) indicate airflow/local ambient combinations that exceed the allowable case temperature for the VAL VISTA. See 4.1, "Typical System Definitions" for system definitions.



5.0 Thermal Enhancements

One method frequently used to improve thermal performance, is to increase the component surface area, by attaching a metallic heat sink to the component top. Increasing the surface area of the heat sink, reduces the thermal resistance from the heat sink, to the air increasing heat transfer.

5.1 Clearances

To be effective, a heat sink requires a pocket of air around it free of obstructions. Though each design may have unique mechanical restrictions, the recommended clearance zones for a heat sink used with the 413808 and 413812 are shown in [Figure 3](#).

Figure 3. Intel® 413808 and 413812 SAS/SATA I/O controllers Heat Sink Keep-out Restriction

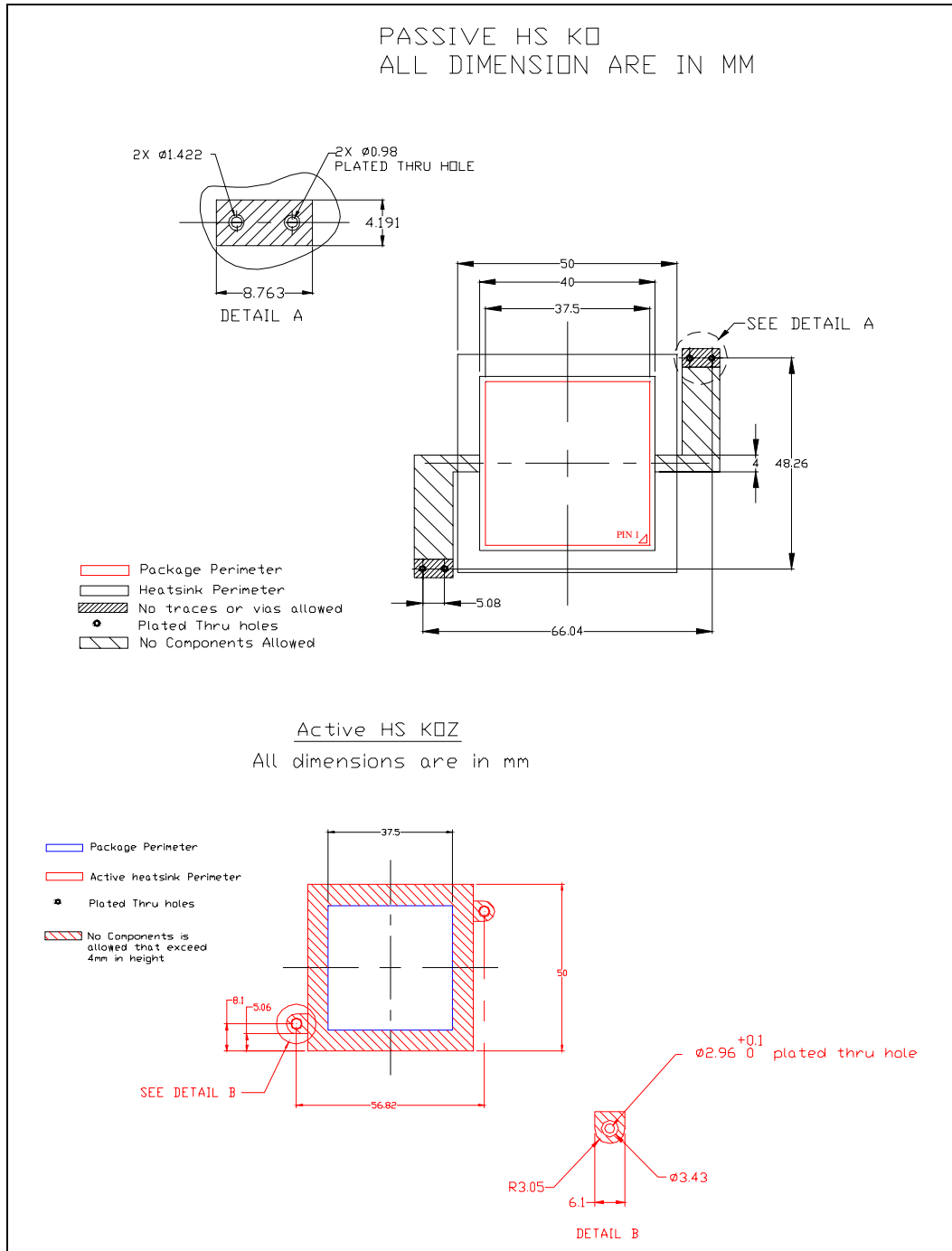



5.2 Default Enhanced Thermal Solution

When there is no control over the end-user thermal environment or when wanting to bypass the thermal modeling and evaluation process, use the Default Enhanced Thermal Solution (discussed in the following section). The Default Enhanced Thermal Solution replicates the performance defined in [Table 4, "Expected Tcase \(°C\) for heat sink \(40x40x18mm\) attached at TDP" on page 14](#), at the thermal design power. When the case temperature continues to exceed the appropriate value listed in [Table 3, "Intel® 413808 and 413812 SAS/SATA I/O Controllers Thermal Absolute Maximum Rating" on page 11](#), after implementing the Default Enhanced Thermal Solution, additional cooling is needed, see [Figure 2, "Maximum Allowable Ambient Temperature vs. Air Flow" on page 14](#). This may be achieved by improving airflow to the component and/or adding additional thermal enhancements.



5.3 Extruded Heat Sinks

When required, the following extruded heat sinks are the suggested 413808 and 413812 thermal solution. [Figure 4](#) shows the heat sink drawing. Heat sinks and their sources are provided in [Appendix A, "Heat Sink and Attach Suppliers"](#).

Figure 4. Intel® 413808 and 413812 SAS/SATA I/O controllers Extruded Heat sink (reference only)

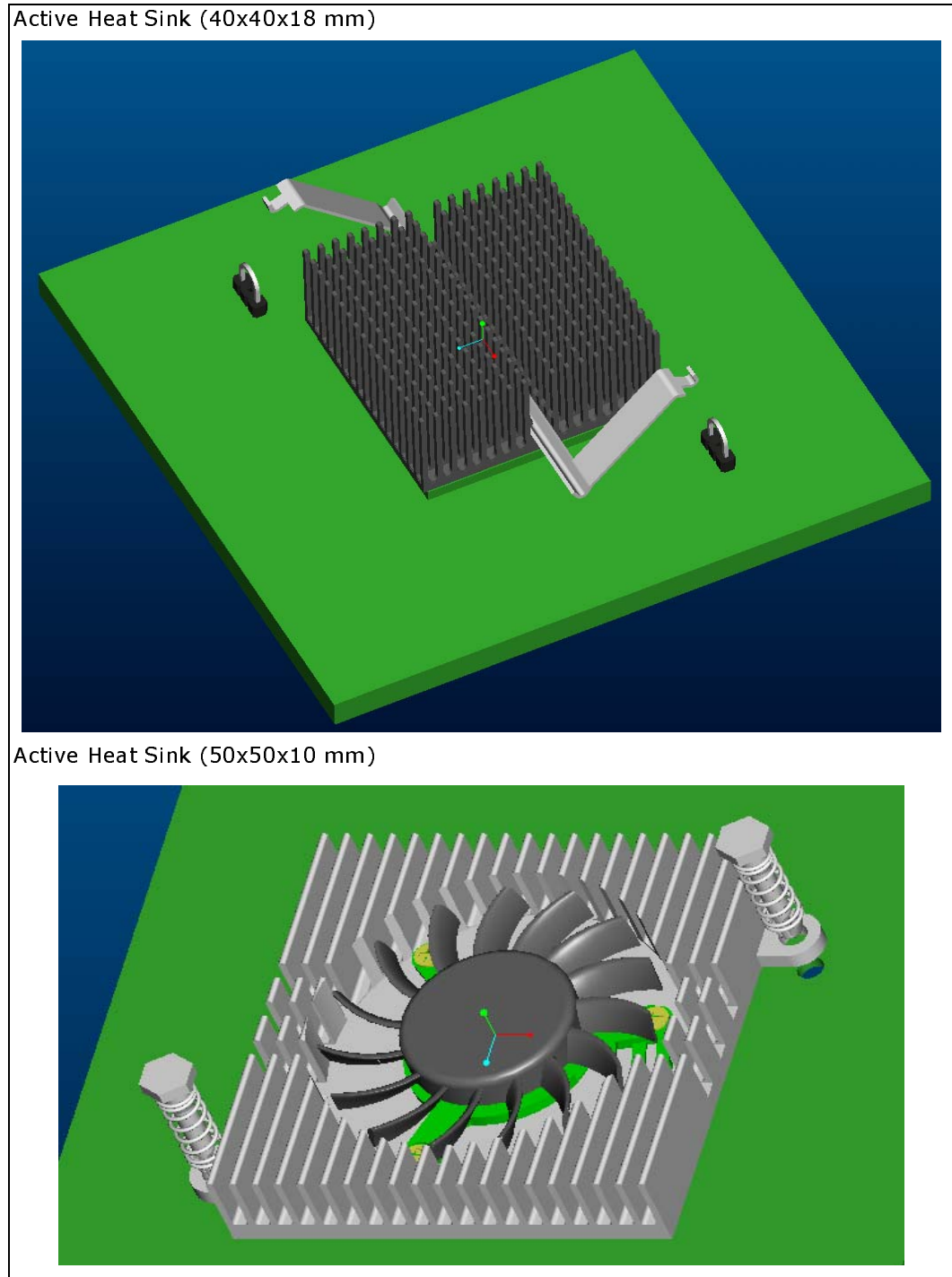



5.4 Attaching the Extruded Heat sink

The extruded heat sink may be attached using clips with a phase change thermal interface material.

5.4.1 Clips

A well-designed clip, in conjunction with a thermal interface material (tape, grease, etc.), often offers the best combination of mechanical stability and rework-ability. Use of a clip requires significant advance planning, since mounting holes are required in the PCB. Use non-plated mounting, with a grounded annular ring on the solder side of the board surrounding the hole. For a typical low-cost clip, set the annular ring inner diameter to 150 mils and an outer diameter to 300 mils. Define the ring to have at least eight ground connections. Set the solder mask opening for these holes with a radius of 300 mils.

5.4.2 Thermal Interface Material (PCM45F)

The recommended thermal interface is PCM45F from Honeywell. The PCM45F thermal interface pads are phase-change materials, formulated for use in high-performance devices, requiring minimum thermal resistance for maximum heat sink performance and component reliability. These pads consist of an electrically non-conductive dry film, that softens at device operating temperatures, resulting in “grease-like” performance. However, Intel has not fully validated the PCM45F TIM.

Following the manufacturers recommended attach procedure list for the recommended thermal interface.

1. Ensure that the component surface and heat sink are free from contamination. Using proper safety precautions clean the package top with a lint-free wipe and Isopropyl Alcohol.
2. Pre-heat the heat sink to 50°C. Remove the Honeywell PCM45F from the carrier. For best result, Peel the TIM off of the carrier by peeling back the carrier at 180 degrees. See [Figure 5, “PCM45F Attach Process \(in roll formal\)” on page 21](#).
3. Carefully position the pad onto heat sink.
4. Apply 10 PSI pressure to the PCM45F pad and let the heat sink cool to room temperature (25°C).
5. Remove the top liner. Peel back at 180 degrees to prevent voids and achieve best results. See [Figure 5, “PCM45F Attach Process \(in roll formal\)” on page 21](#).
6. Dents and minor scratches in the material do not affect performance, since the material is designed to flow at typical operating temperatures. Honeywell pads can be removed for rework using a single-edged razor and then cleaning the surface with isopropyl (IPA) solvent.

Note: Each PCA, system and heat sink combination varies in attach strength. Carefully evaluate the reliability of tape attachments prior to high-volume use (See [Section 5.5, “Reliability” on page 22](#)).

Figure 5. PCM45F Attach Process (in roll format)

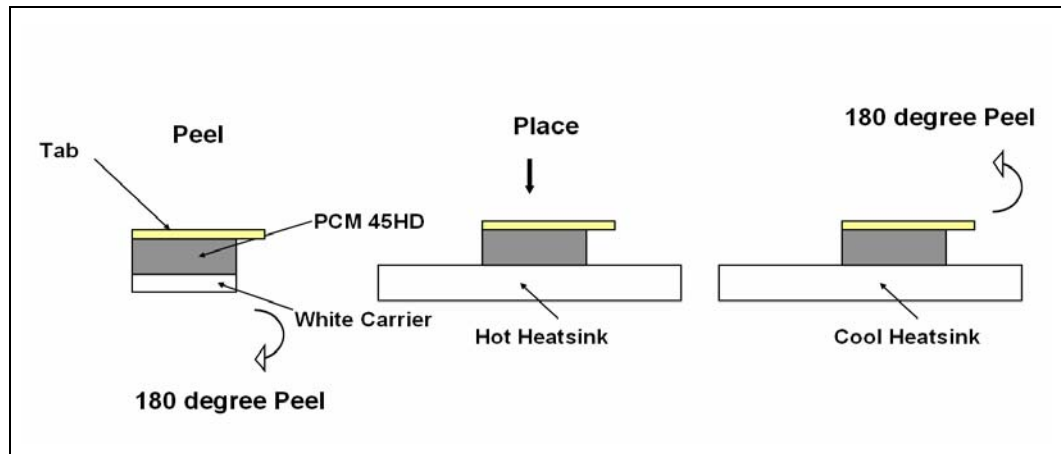
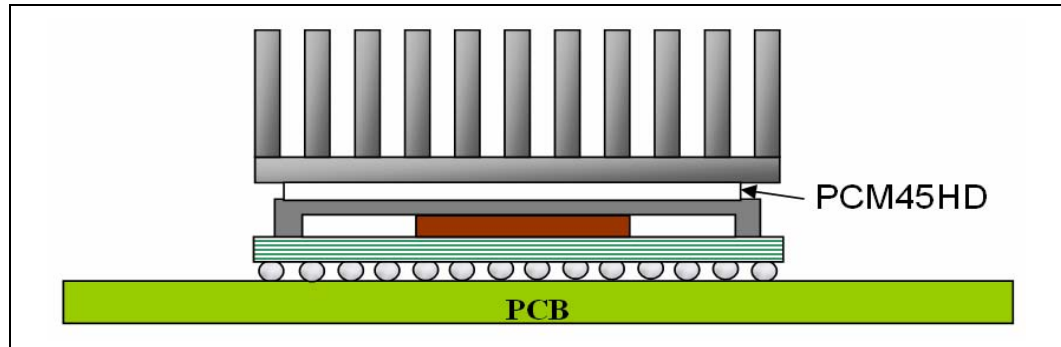

Figure 6. Completing the Attach Process





5.5 Reliability

Each PCA, system and heat sink combination varies in attach strength and long-term adhesive performance. Carefully evaluate the reliability of the completed assembly prior to high-volume use. Some reliability recommendations are shown in [Table 5](#).

Table 5. Reliability Validation

Test ¹	Requirement	Pass/Fail Criteria ²
Mechanical Shock	50 G, board level 11 ms, three shocks/axis.	Visual and Electrical Check
Random Vibration	7.3 G, board level 45 minutes/axis, 50 to 2000 Hz.	
High-Temperature Life	85°C 2000 hours total Checkpoints occur at 168, 500, 1000, and 2000 hours.	Visual and Mechanical Check
Thermal Cycling	Per-Target Environment (for example: -40°C to +85°C) 500 Cycles.	
Humidity	85% relative humidity 85°C, 1000 hours.	

1. Performed the above tests on a sample size of at least 12 assemblies from 3 lots of material (total = 36 assemblies).
2. Additional Pass/Fail Criteria can be added at your discretion.



5.6 Thermal Interface Management for Heat-Sink Solutions

To optimize the 413808 and 413812 heat sink design, it is important to understand the interface between the heat spreader and the heat sink base. Specifically, thermal conductivity effectiveness depends on the following:

- Bond line thickness
- Interface material area
- Interface material thermal conductivity

5.6.1 Bond Line Management

The gap between the heat spreader and the heat sink base impacts heat-sink solution performance. The larger the gap between the two surfaces, the greater the thermal resistance. The thickness of the gap is determined by the flatness of both the heat sink base and the heat spreader, plus the thickness of the thermal interface material (for example, PSA, thermal grease, epoxy) used to join the two surfaces.

Note: The planarity of the 413808 and 413812 package is eight mils.

5.6.2 Interface Material Performance

The following two factors impact the performance of the interface material between the heat spreader and the heat sink base:

- Thermal resistance of the material
- Wetting/filling characteristics of the material

5.6.2.1 Thermal Resistance of the Material

Thermal resistance describes the ability of the thermal interface material to transfer heat from one surface to another. The higher the thermal resistance, the less efficient the heat transfers. The thermal resistance of the interface material has a significant impact on the thermal performance of the overall thermal solution. The higher the thermal resistance, the larger the temperature drop is required across the interface.

5.6.2.2 Wetting/Filling Characteristics of the Material

The wetting/filling characteristic, of the thermal interface material, is its ability to fill the gap between the heat spreader top surface and the heat sink. Since air is an extremely poor thermal conductor, the more completely the interface material fills the gaps, the lower the temperature-drop across the interface, increasing the efficiency of the thermal solution.



6.0 Measurements for Thermal Specifications

Determining the thermal properties of the system requires careful case temperature measurements. Guidelines for measuring 413808 and 413812 case temperature are provided in [Section 6.1](#).

6.1 Case Temperature Measurements

Maintain 413808 and 413812 T_{case} at or below the maximum case temperatures listed in [Table 3, "Intel® 413808 and 413812 SAS/SATA I/O Controllers Thermal Absolute Maximum Rating" on page 11](#) to ensure functionality and reliability. Special care is required when measuring the case temperature to ensure an accurate temperature measurement. Use the following guidelines when making case measurements:

- Measure the surface temperature of the case in the geometric center of the case top.
- Calibrate the thermocouples used to measure T_{case} before making temperature measurements.
- Use 36-gauge (maximum) K-type thermocouples.

Care must be taken to avoid introducing errors into the measurements when measuring a surface temperature that is a different temperature from the surrounding local ambient air. Measurement errors may be due to:

- A poor thermal contact between the thermocouple junction and the surface of the package
- Heat loss by radiation
- Convection
- Conduction through thermocouple leads
- Contact between the thermocouple cement and the heat-sink base (when used)

6.1.1 Attaching the Thermocouple (Heat Sink)

The following approach is recommended to minimize measurement errors for attaching the thermocouple with heat sink:

- Use 36 gauge or smaller diameter K-type thermocouples.
- Ensure that the thermocouple is properly calibrated.
- Attach the thermocouple bead or junction to the case top surface in the geometric center using high thermal conductivity cement.

Note:

It is critical that the entire thermocouple lead be butted tightly against the case.

- Attach the thermocouple at a 90° angle when there is no interference with the thermocouple attach location or leads (refer to [Figure 7](#)). This is the preferred method and is recommended for use with packages with heat sinks.
- For testing purposes, a hole (no larger than 0.150" in diameter) must be drilled vertically through the center of the heat sink to route the thermocouple wires out.
- Ensure there is no contact between the thermocouple cement and heat sink base. Any contact affects the thermocouple reading.

Figure 7. Technique for Measuring T_{case} with 90° Angle Attachment

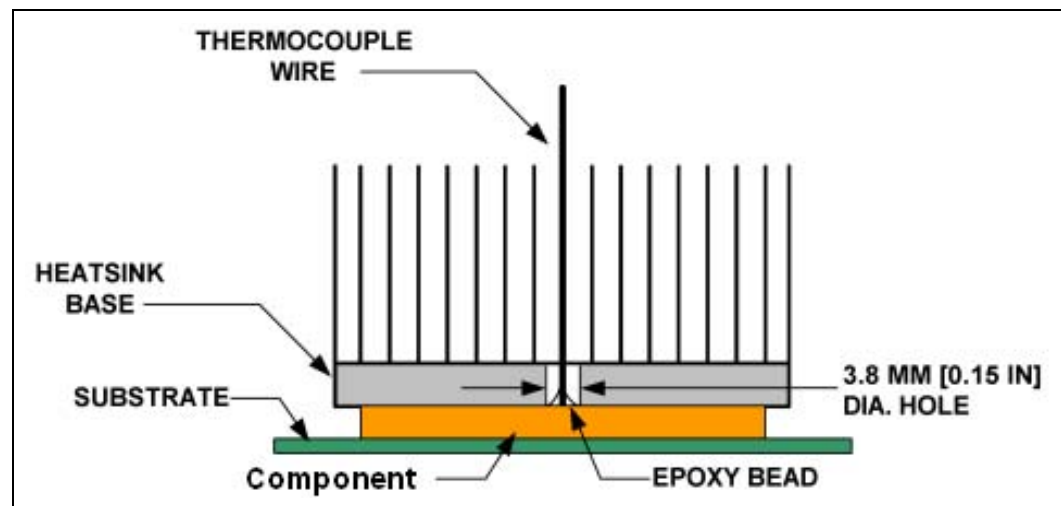



7.0 Thermal Diode

The 413808 and 413812 processor incorporates an on-die diode that may be used to monitor the die temperature (junction temperature). A thermal sensor located on the motherboard or a stand-alone measurement kit, may monitor the die temperature of the 413808 and 413812 for thermal management or characterization.

Table 6. Thermal Diode Parameters

Symbol	Minimum	Typical	Maximum	Unit	Notes
I forward bias	1		300	μA	1
n_ideality	1.0177	1.0188	1.0216		2,4
ESR	3.8 @ 20C	5.6 @ 80C	7.8 @ 100C	ohm	3

Notes:

1. Intel does not support or recommend operation of the thermal diode under reverse bias.
2. At room temperature with a forward bias of 630 mV.
3. ESR: Effective Series Resistance - needed for various TD measurement tools.
4. n_ideality is the diode ideality factor parameter, as represented by the diode equation:

$$I = I_0 \left(e^{\frac{eV_D}{nkT}} - 1 \right)$$

Table 7. Thermal Diode Interface

Pin Name	Pin/Ball Number	Pin Description
X_THERMDA	Y29	Diode anode (p_junction)
X_THERMDC	W29	Diode cathode (n_junction)



8.0 Conclusion

Increasingly complex systems require better power dissipation. Care must be taken to ensure that the additional power is properly dissipated. Heat can be dissipated using improved system cooling, selective use of ducting, passive or active heat sinks, or any combination.

The simplest and most cost effective method is to improve the inherent system cooling characteristics through careful design and placement of fans, vents, and ducts. When additional cooling is required, thermal enhancements may be implemented in conjunction with enhanced system cooling. The size of the fan or heat sink can be varied to balance size and space constraints with acoustic noise.

This document has presented the conditions and requirements to properly design a cooling solution for systems implementing the 413808 and 413812. Properly designed solutions provide adequate cooling to maintain the 413808 and 413812 case temperature at or below those listed in [Table 2, "Package Thermal Characteristics in Standard JEDEC Environment" on page 72](#). Ideally, this is accomplished by providing a low local ambient temperature and creating a minimal thermal resistance to that local ambient temperature. Alternatively, heat sinks may be required when case temperatures exceed those listed in [Table 2](#).

By maintaining the 413808 and 413812 case temperature at or below those recommended in this document, the 413808 and 413812 functions properly and reliably.

Use this document to understand the 413808 and 413812 thermal characteristics and compare them to the system environment. Measure the 413808 and 413812 case temperatures to determine the best thermal solution for your design.



Appendix A: Heat Sink and Attach Suppliers

Table 8. Heat Sink and Attach Suppliers

Part	Part number	Supplier	Contact information
40x40x18 mm Extruded Al Heat sink	ECB-00178-01	Cooler Master	Wendy Lin Cooler Master USA Inc., NJ office 603 First Ave., Unit 2C Raritan, NJ, 08869, USA Tel: 1-908-252-9400 Fax: 1-908-252-9299 wendy@coolermaster.com
50x50x10mm fan sink	ECB-00171-01		
PCM45 Series	PCM45F	Honeywell	North America Technical Contact: Paula Knoll 1349 Moffett Park Dr. Sunnyvale, CA 94089 Cell: 1-858-705-1274 Buisness: 858-279-2956 Paula.knoll@honeywell.com

Appendix B: PCB Guidelines

The following general PCB design guidelines are recommended to maximize the thermal performance of FCBGA packages:

1. When connecting ground (thermal) vias-to the ground planes do not use thermal-relief patterns.
2. Thermal-relief patterns are designed to limit heat transfer between the vias and the copper planes, thus constricting the heat flow path from the component to the ground planes in the PCB.
3. As board temperature also has an effect on the thermal performance of the package, avoid placing the 413808 and 413812 adjacent to high-power dissipation devices.
4. When airflow exists, locate the components in the mainstream of the airflow path for maximum thermal performance. Avoid placing the components downstream, behind larger devices or devices with heat sinks that obstruct the air flow or supply excessively heated air.

Note: The above guidelines are not all inclusive and are defined to give you known, good design practices to maximize the thermal performance of the components.

