

Intel[®] Core[™] i7-800 and i5-700 Desktop Processor Series

Datasheet – Volume 2

September 2009



INFORMATION IN THIS DOCUMENT IS PROVIDED IN CONNECTION WITH INTEL® PRODUCTS. NO LICENSE, EXPRESS OR IMPLIED, BY ESTOPPEL OR OTHERWISE, TO ANY INTELLECTUAL PROPERTY RIGHTS IS GRANTED BY THIS DOCUMENT. EXCEPT AS PROVIDED IN INTEL'S TERMS AND CONDITIONS OF SALE FOR SUCH PRODUCTS, INTEL ASSUMES NO LIABILITY WHATSOEVER, AND INTEL DISCLAIMS ANY EXPRESS OR IMPLIED WARRANTY, RELATING TO SALE AND/OR USE OF INTEL PRODUCTS INCLUDING LIABILITY OR WARRANTIES RELATING TO FITNESS FOR A PARTICULAR PURPOSE, MERCHANTABILITY, OR INFRINGEMENT OF ANY PATENT, COPYRIGHT OR OTHER INTELLECTUAL PROPERTY RIGHT. Intel products are not intended for use in medical, life saving, life sustaining, critical control or safety systems, or in nuclear facility applications.

Intel may make changes to specifications and product descriptions at any time, without notice.

Designers must not rely on the absence or characteristics of any features or instructions marked "reserved" or "undefined." Intel reserves these for future definition and shall have no responsibility whatsoever for conflicts or incompatibilities arising from future changes to them.

The Intel Core™ i7-800 and i5-700 desktop processor series may contain design defects or errors known as errata which may cause the product to deviate from published specifications. Current characterized errata are available on request.

¹Intel processor numbers are not a measure of performance. Processor numbers differentiate features within each processor family, not across different processor families. See http://www.intel.com/products/processor_number for details. Over time processor numbers will increment based on changes in clock, speed, cache, FSB, or other features, and increments are not intended to represent proportional or quantitative increases in any particular feature. Current roadmap processor number progression is not necessarily representative of future roadmaps. See www.intel.com/products/processor_number for details.

No computer system can provide absolute security under all conditions. Intel® Trusted Execution Technology (Intel® TXT) requires a computer system with Intel® Virtualization Technology, an Intel TXT-enabled processor, chipset, BIOS, Authenticated Code Modules and an Intel TXT-compatible measured launched environment (MLE). The MLE could consist of a virtual machine monitor, an OS or an application. In addition, Intel TXT requires the system to contain a TPM v1.2, as defined by the Trusted Computing Group and specific software for some uses. For more information, see <http://www.intel.com/technology/security/>.

Intel® Virtualization Technology requires a computer system with an enabled Intel® processor, BIOS, virtual machine monitor (VMM) and, for some uses, certain platform software enabled for it. Functionality, performance or other benefits will vary depending on hardware and software configurations and may require a BIOS update. Software applications may not be compatible with all operating systems. Please check with your application vendor.

Intel® Active Management Technology requires the computer system to have an Intel(R) AMT-enabled chipset, network hardware and software, as well as connection with a power source and a corporate network connection. Setup requires configuration by the purchaser and may require scripting with the management console or further integration into existing security frameworks to enable certain functionality. It may also require modifications of implementation of new business processes. With regard to notebooks, Intel AMT may not be available or certain capabilities may be limited over a host OS-based VPN or when connecting wirelessly, on battery power, sleeping, hibernating or powered off. For more information, see www.intel.com/technology/platform-technology/intel-amt/

Enabling Execute Disable Bit functionality requires a PC with a processor with Execute Disable Bit capability and a supporting operating system. Check with your PC manufacturer on whether your system delivers Execute Disable Bit functionality.

Contact your local Intel sales office or your distributor to obtain the latest specifications and before placing your product order.

Copies of documents which have an order number and are referenced in this document, or other Intel literature may be obtained by calling 1-800-548-4725 or by visiting Intel's website at <http://www.intel.com>.

Intel, Intel Core, Intel Scalable Memory Interconnect (Intel SMI), Intel Virtualization Technology for Directed I/O, Intel Trusted Execution Technology (Intel TXT), Intel Management Engine (Intel ME), Intel Interconnect BIST (Intel IBIST), and the Intel logo are trademarks of Intel Corporation in the U. S. and other countries.

*Other names and brands may be claimed as the property of others.

Copyright © 2009, Intel Corporation. All Rights Reserved.



Contents

1	Introduction	17
1.1	Register Terminology	17
2	Configuration Process and Registers	19
2.1	Platform Configuration Structure	19
2.1.1	Processor Integrated I/O (IIO) Devices (PCI Bus 0)	19
2.1.2	Processor Uncore Devices (PCI Bus — FFh)	20
2.2	Configuration Mechanisms	21
2.2.1	Standard PCI Express* Configuration Mechanism	21
2.2.2	PCI Express* Configuration Mechanism	21
2.3	Routing Configuration Accesses	23
2.3.1	Internal Device Configuration Accesses	24
2.3.2	Bridge-Related Configuration Accesses	24
2.3.2.1	PCI Express* Configuration Accesses	24
2.3.2.2	DMI Configuration Accesses	25
2.4	Processor Register Introduction	25
2.5	I/O Mapped Registers	26
3	Processor Integrated I/O (IIO) Configuration Registers	27
3.1	Processor IIO Devices (PCI Bus 0)	27
3.2	Device Mapping	28
3.2.1	Unimplemented Devices/Functions and Registers	28
3.3	PCI Express*/DMI Configuration Registers	28
3.3.1	Other Register Notes	28
3.3.2	Configuration Register Map	29
3.3.3	Standard PCI Configuration Space (0h to 3Fh) — Type 0/1 Common Configuration Space	35
3.3.3.1	VID—Vendor Identification Register	35
3.3.3.2	DID—Device Identification Register	35
3.3.3.3	PCICMD—PCI Command Register	36
3.3.3.4	PCISTS—PCI Status Register	38
3.3.3.5	RID—Revision Identification Register	40
3.3.3.6	CCR—Class Code Register	40
3.3.3.7	CLSR—Cacheline Size Register	41
3.3.3.8	PLAT—Primary Latency Timer	41
3.3.3.9	HDR—Header Type Register	41
3.3.3.10	SVID—Subsystem Vendor ID	42
3.3.3.11	SID—Subsystem Identity	42
3.3.3.12	CAPPTR—Capability Pointer	42
3.3.3.13	INTLIN—Interrupt Line Register	42
3.3.3.14	INTPIN—Interrupt Pin Register	43
3.3.3.15	PBUS—Primary Bus Number Register	43
3.3.3.16	SECBUS—Secondary Bus Number	43
3.3.3.17	SUBBUS—Subordinate Bus Number Register	44
3.3.3.18	IOBAS—I/O Base Register	44
3.3.3.19	IOLIM—I/O Limit Register	45
3.3.3.20	SECSTS—Secondary Status Register	46
3.3.3.21	MBAS—Memory Base	47
3.3.3.22	MLIM—Memory Limit	47
3.3.3.23	PMBASE—Prefetchable Memory Base Register	48
3.3.3.24	PMLIMIT—Prefetchable Memory Limit	48
3.3.3.25	PMBASEU—Prefetchable Memory Base (Upper 32 bits)	49
3.3.3.26	PMLIMITU—Prefetchable Memory Limit (Upper 32 bits)	49
3.3.3.27	BCTRL—Bridge Control Register	50
3.3.4	Device-Specific PCI Configuration Space — 40h to FFh	51
3.3.4.1	SCAPID—Subsystem Capability Identity	51



3.3.4.2	SNXTPTR—Subsystem ID Next Pointer	51
3.3.4.3	SVID—Subsystem Vendor ID	52
3.3.4.4	SID—Subsystem Identity	52
3.3.4.5	DMIRCBAR—DMI Root Complex Register Block Base Address Register	52
3.3.4.6	MSICAPID—MSI Capability ID	53
3.3.4.7	MSINXTPTR—MSI Next Pointer	53
3.3.4.8	MSICTRL—MSI Control Register	53
3.3.4.9	MSIAR—MSI Address Register	54
3.3.4.10	MSIDR—MSI Data Register	55
3.3.4.11	MSIMSK—MSI Mask Bit Register	55
3.3.4.12	MSIPENDING—MSI Pending Bit Register	56
3.3.4.13	PEGCAPID—PCI Express* Capability Identity Register	56
3.3.4.14	PEGNXTPTR—PCI Express* Next Pointer Register	56
3.3.4.15	PEGCAP—PCI Express* Capabilities Register	57
3.3.4.16	DEVCAP—PCI Express* Device Capabilities Register	58
3.3.4.17	DEVCTRL—PCI Express* Device Control Register	59
3.3.4.18	DEVSTS—PCI Express* Device Status Register	61
3.3.4.19	LNKCAP—PCI Express* Link Capabilities Register	62
3.3.4.20	LNKCON—PCI Express* Link Control Register (Device 0)	64
3.3.4.21	LNKCON—PCI Express* Link Control Register	65
3.3.4.22	LNKSTS—PCI Express* Link Status Register	66
3.3.4.23	SLTCAP—PCI Express* Slot Capabilities Register	68
3.3.4.24	SLTCON—PCI Express* Slot Control Register	69
3.3.4.25	ROOTCON—PCI Express* Root Control Register	70
3.3.4.26	ROOTCAP—PCI Express* Root Capabilities Register	71
3.3.4.27	ROOTSTS—PCI Express* Root Status Register	72
3.3.4.28	DEVCAP2—PCI Express* Device Capabilities Register 2	73
3.3.4.29	DEVCTRL2—PCI Express* Device Control Register 2	74
3.3.4.30	LNKCON2—PCI Express* Link Control Register 2	75
3.3.4.31	LNKSTS2—PCI Express* Link Control Register 2	76
3.3.4.32	PMCAP—Power Management Capabilities Register	76
3.3.4.33	PMCSR—Power Management Control and Status Register (Device 0 DMI)	77
3.3.4.34	PMCSR—Power Management Control and Status Register	78
3.3.5	PCIe/DMI Extended Configuration Space	79
3.3.5.1	APICBASE—APIC Base Register	79
3.3.5.2	APICLIMIT—APIC Limit Register	79
3.3.5.3	PERFCTRLSTS—Performance Control and Status Register	79
3.3.5.4	MISCCTRLSTS—Miscellaneous Control and Status Register	81
3.3.5.5	CTOCTRL—Completion Time-out Control Register	83
3.3.6	DMI Root Complex Register Block	84
3.3.6.1	DMIVCH—DMI Virtual Channel Capability Header	85
3.3.6.2	DMIVCCAP1—DMI Port VC Capability Register 1	85
3.3.6.3	DMIVCCAP2—DMI Port VC Capability Register 2	86
3.3.6.4	DMIVCCTL—DMI Port VC Control	86
3.3.6.5	DMIVCORCAP—DMI VC0 Resource Capability	87
3.3.6.6	DMIVCORCTL—DMI VC0 Resource Control	87
3.3.6.7	DMIVCORSTS—DMI VC0 Resource Status	88
3.3.6.8	DMIVC1RCAP—DMI VC1 Resource Capability	88
3.3.6.9	DMIVC1RCTL—DMI VC1 Resource Control	89
3.3.6.10	DMIVC1RSTS—DMI VC1 Resource Status	90
3.3.6.11	DMILCAP—DMI Link Capabilities	90
3.3.6.12	DMILCTRL—DMI Link Control	91
3.3.6.13	DMILSTS—DMI Link Status	91
3.4	Integrated I/O Core Registers (Device 8, Function 0-3)	92
3.4.1	Configuration Register Map (Device 8, Function 0-3)	92
3.4.2	Standard PCI Configuration Registers	98
3.4.2.1	VID—Vendor Identification Register	98
3.4.2.2	DID—Device Identification Register	98
3.4.2.3	PCICMD—PCI Command Register	98



3.4.2.4	PCISTS—PCI Status Register	101
3.4.2.5	RID—Revision Identification Register	103
3.4.2.6	CCR—Class Code Register	103
3.4.2.7	CLSR—Cacheline Size Register	103
3.4.2.8	HDR—Header Type Register	104
3.4.2.9	SVID—Subsystem Vendor ID	104
3.4.2.10	SID—Subsystem Device ID	104
3.4.2.11	CAPPTR—Capability Pointer	104
3.4.2.12	INTLIN—Interrupt Line Register	105
3.4.2.13	INTPIN—Interrupt Pin Register	105
3.4.3	Common Extended Configuration Space Registers	105
3.4.3.1	CAPID—PCI Express® Capability List Register	105
3.4.3.2	NXTPTR—PCI Express® Next Capability List Register	106
3.4.3.3	EXPCAP—PCI Express® Capabilities Register	106
3.4.3.4	DEVCAP—PCI Express® Device Capabilities Register	107
3.4.3.5	DEVCTRL—PCI Express® Device Control Register	108
3.4.3.6	DEVSTS—PCI Express® Device Status Register	110
3.4.4	Intel® VT-d, Address Mapping, System Management Registers (Device 8, Function 0)	111
3.4.4.1	IOMISCCTRL—Integrated I/O Misc Control Register	111
3.4.4.2	IOMISCSS—Integrated I/O MISC Status	112
3.4.4.3	TSEGCTRL—TSEG Control Register	112
3.4.4.4	TOLM—Top of Low Memory	113
3.4.4.5	TOHM—Top of High Memory	113
3.4.4.6	NCMEM.BASE—NCMEM Base	113
3.4.4.7	NCMEM.LIMIT—NCMEM Limit	114
3.4.4.8	DEVHIDE1—Device Hide 1 Register	114
3.4.4.9	DEVHIDE2—Device Hide 2 Register	117
3.4.4.10	IIOBUSNO—IIO Internal Bus Number	118
3.4.4.11	LMMIOL.BASE—Local MMIO Base	118
3.4.4.12	LMMIOL.LIMIT—Local MMIO Limit	119
3.4.4.13	LMMIOH.BASE—Local MMIOH Base	119
3.4.4.14	LMMIOH.LIMIT—Local MMIOH Limit	119
3.4.4.15	LMMIOH.BASEU—Local MMIOH Base Upper	120
3.4.4.16	LMMIOH.LIMITU—Local MMIOH Limit Upper	120
3.4.4.17	LCFGBUS.BASE—Local Configuration Bus Number Base Register ..	120
3.4.4.18	LCFGBUS.LIMIT—Local Configuration Bus Number Limit Register ...	121
3.4.4.19	GMMIOL.BASE—Global MMIO Base	121
3.4.4.20	GMMIOL.LIMIT—Global MMIO Limit	121
3.4.4.21	GMMIOH.BASE—Global MMIOH Base	122
3.4.4.22	GMMIOH.LIMIT—Global MMIOH Limit	122
3.4.4.23	GMMIOH.BASEU—Global MMIOH Base Upper	123
3.4.4.24	GMMIOH.LIMITU—Global MMIOH Limit Upper	123
3.4.4.25	GCFGBUS.BASE—Global Configuration Bus Number Base Register .	123
3.4.4.26	GCFGBUS.LIMIT—Global Configuration Bus Number Limit Register.	124
3.4.4.27	MESEGBASE—Intel® Management Engine (Intel® ME) Memory Region Base	124
3.4.4.28	MESEGMASK—Intel® ME Memory Region Mask	124
3.4.4.29	VTBAR—Base Address Register for Intel® VT-d Chipset Registers ..	125
3.4.4.30	VTGENCTRL—Intel® VT-d General Control Register	126
3.4.4.31	VTISOCHCTRL—Intel VT-d Isoch Related Control Register	127
3.4.4.32	VTGENCTRL2—Intel VT-d General Control 2 Register	127
3.4.4.33	VTSTS—Intel® VT-d Status Register	128
3.4.5	Semaphore and ScratchPad Registers (Dev: 8, F: 1)	128
3.4.5.1	SR[0:3]—Scratch Pad Register 0-3 (Sticky)	128
3.4.5.2	SR[4:7]—Scratch Pad Register 4-7 (Sticky)	128
3.4.5.3	SR[8:11]—Scratch Pad Register 8-11 (Non-Sticky)	128
3.4.5.4	SR[12:15]—Scratch Pad Register 12-15 (Non-Sticky)	129
3.4.5.5	SR[16:17]—Scratch Pad Register 16-17 (Non-Sticky)	129
3.4.5.6	SR[18:23]—Scratch Pad Register 18-23 (Non-Sticky)	129
3.4.5.7	CWR[0:3]—Conditional Write Registers 0-3	129



3.4.5.8	CWR[4:7]—Conditional Write Registers 4-7.....	130
3.4.5.9	CWR[8:11]—Conditional Write Registers 8-11.....	130
3.4.5.10	CWR[12:15]—Conditional Write Registers 12-15.....	130
3.4.5.11	CWR[16:17]—Conditional Write Registers 16-17.....	131
3.4.5.12	CWR[18:23]—Conditional Write Registers 18-23.....	131
3.4.5.13	IR[0:3]—Increment Registers 0-3.....	131
3.4.5.14	IR[4:7]—Increment Registers 4-7.....	132
3.4.5.15	IR[8:11]—Increment Registers 8-11.....	132
3.4.5.16	IR[12:15]—Increment Registers 12-15.....	132
3.4.5.17	IR[16:17]—Increment Registers 16-17.....	133
3.4.5.18	IR[18:23]—Increment Registers 18-23.....	133
3.4.6	System Control/Status Registers (Device 8, Function 2).....	134
3.4.6.1	SYSMAP—System Error Event Map Register.....	134
3.4.6.2	GENMCA—Generate MCA.....	134
3.4.6.3	SYRE—System Reset.....	135
3.4.7	Miscellaneous Registers (Dev: 8, F: 3).....	135
3.4.7.1	IIOSLPSTS_L—IIO Sleep Status Low Register.....	135
3.4.7.2	IIOSLPSTS_H—IIO Sleep Status High Register.....	136
3.4.7.3	PMUSTATE—Power Management State Register.....	136
3.4.7.4	CTSTS—Throttling Status Register.....	137
3.4.7.5	CTCTRL—Throttling Control Register.....	137
3.5	Intel® VT-d Memory Mapped Registers.....	137
3.5.1	Intel® VT-d Configuration Register Space (MMIO).....	138
3.5.2	Register Description.....	141
3.5.2.1	VTD_VERSION[0:1]—Version Number Register.....	141
3.5.2.2	VTD_CAP[0:1]—Intel® VT-d Chipset Capabilities Register.....	142
3.5.2.3	EXT_VTD_CAP[0:1]—Extended Intel® VT-d Capability Register.....	143
3.5.2.4	GLBCMD[0:1]—Global Command Register.....	144
3.5.2.5	GLBSTS[0:1]—Global Status Register.....	145
3.5.2.6	ROOTENTRYADD[0:1]—Root Entry Table Address Register.....	145
3.5.2.7	CTXCMD[0:1]—Context Command Register.....	146
3.5.2.8	FLTSTS[0:1]—Fault Status Register.....	147
3.5.2.9	FLTEVTCTRL[0:1]—Fault Event Control Register.....	148
3.5.2.10	FLTEVTDATA[0:1]—Fault Event Data Register.....	149
3.5.2.11	FLTEVTADDR[0:1]—Fault Event Address Register.....	149
3.5.2.12	FLTEVTUPRADDR[0:1]—Fault Event Upper Address Register.....	149
3.5.2.13	PMEN[0:1]—Protected Memory Enable Register.....	149
3.5.2.14	PROT_LOW_MEM_BASE[0:1]—Protected Memory Low Base Register.....	150
3.5.2.15	PROT_LOW_MEM_LIMIT[0:1]—Protected Memory Low Limit Register.....	150
3.5.2.16	PROT_HIGH_MEM_BASE[0:1]—Protected Memory High Base Register.....	150
3.5.2.17	PROT_HIGH_MEM_LIMIT[0:1]—Protected Memory Limit Base Register.....	151
3.5.2.18	INV_QUEUE_HEAD[0:1]—Invalidation Queue Header Pointer Register.....	151
3.5.2.19	INV_QUEUE_TAIL[0:1]—Invalidation Queue Tail Pointer Register.....	151
3.5.2.20	INV_QUEUE_ADD[0:1]—Invalidation Queue Address Register.....	152
3.5.2.21	INV_COMP_STATUS[0:1]—Invalidation Completion Status Register.....	152
3.5.2.22	INV_COMP_EVT_CTL[0:1]—Invalidation Completion Event Control Register.....	153
3.5.2.23	INV_COMP_EVT_DATA[0:1]—Invalidation Completion Event Data Register.....	153
3.5.2.24	INV_COMP_EVT_ADDR[0:1]—Invalidation Completion Event Address Register.....	153
3.5.2.25	INV_COMP_EVT_UPRADDR[0:1]—Invalidation Completion Event Upper Address Register.....	154

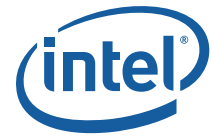

3.5.2.26	INTR_REMAP_TABLE_BASE[0:1]—Interrupt Remapping Table Base Address Register	154
3.5.2.27	FLTREC[10,7:0]—Fault Record Register	155
3.5.2.28	INVADDRREG[0:1]—Invalidate Address Register	155
3.5.2.29	IOTLBINV[0:1]—IOTLB Invalidate Register	156
3.6	Intel® Trusted Execution Technology (Intel® TXT) Register Map	157
3.6.1	Intel® TXT Space Registers	162
3.6.1.1	TXT.STS—Intel® TXT Status Register	162
3.6.1.2	TXT.ESTS—Intel® TXT Error Status Register	164
3.6.1.3	TXT.THREADS.EXISTS—Intel® TXT Thread Exists Register	165
3.6.1.4	TXT.THREADS.JOIN—Intel® TXT Threads Join Register	165
3.6.1.5	TXT.ERRORCODE—Intel® TXT Error Code Register	166
3.6.1.6	TXT.CMD.RESET—Intel® TXT System Reset Command Register	166
3.6.1.7	TXT.CMD.CLOSE_PRIVATE—Intel® TXT Close Private Command Register	167
3.6.1.8	TXT.VER.QPIIF	167
3.6.1.9	TXT.ID—Intel® TXT Identifier Register	168
3.6.1.10	TXT.CMD.LOCK.BASE—Intel® TXT Lock Base Command Register	168
3.6.1.11	TXT.CMD.UNLOCK.BASE—Intel® TXT Unlock Base Command Register	169
3.6.1.12	TXT.SINIT.MEMORY.BASE—Intel® TXT SINIT Code Base Register	169
3.6.1.13	TXT.SINIT.MEMORY.SIZE—Intel® TXT SINIT Memory Size Register	170
3.6.1.14	TXT.MLE.JOIN—Intel® TXT MLE Join Base Register	170
3.6.1.15	TXT.HEAP.BASE—Intel® TXT HEAP Code Base Register	171
3.6.1.16	TXT.HEAP.SIZE—Intel® TXT HEAP Size Register	171
3.6.1.17	TXT.MSEG.BASE—Intel® TXT MSEG Base Register	172
3.6.1.18	TXT.MSEG.SIZE—Intel® TXT MSEG Size Register	172
3.6.1.19	TXT.SCRATCHPAD0—Intel® TXT Scratch Pad Register 0	173
3.6.1.20	TXT.SCRATCHPAD1—Intel® TXT Scratch Pad Register 1	173
3.6.1.21	TXT.CMD.OPEN.LOCALITY1—Intel® TXT Open Locality 1 Command	174
3.6.1.22	TXT.CMD.CLOSE.LOCALITY1—Intel® TXT Close Locality 1 Command	174
3.6.1.23	TXT.CMD.OPEN.LOCALITY2—Intel® TXT Open Locality 2 Command	174
3.6.1.24	TXT.CMD.CLOSE.LOCALITY2—Intel® TXT Close Locality 2 Command	175
3.6.1.25	TXT.PUBLIC.KEY—Intel® TXT Public Key Hash Register	175
3.7	Intel® QuickPath Interconnect Device/Functions	176
3.7.1	Intel® QuickPath Interconnect Link Layer Registers	177
3.7.1.1	SVID—Subsystem Vendor ID	177
3.7.1.2	SID—Subsystem Device ID	177
3.7.1.3	CAPPTR—Capability Pointer	177
3.7.1.4	QPI[0]LCL—Intel® QuickPath Interconnect Link Control	178
3.7.1.5	QPI[0]LCRDC—Intel® QuickPath Interconnect Link Credit Control	179
3.7.2	Intel® QuickPath Interconnect Routing & Protocol Layer Registers	180
3.7.2.1	QPIPCTRL0—Intel® QuickPath Interconnect Protocol Control 0	181
3.7.2.2	QPIPIsocres—Intel® QuickPath Interconnect Protocol Isochronous Reservation	181
3.7.2.3	CAPHDRH—PCI Express® Capability Header High Register	182
4	Processor Uncore Configuration Registers	183
4.1	Processor Uncore Configuration Structure (PCI Bus — FFh)	183
4.2	Device Mapping	184
4.3	Detailed Configuration Space Maps	185
4.4	PCI Standard Registers	201
4.4.1	VID—Vendor Identification Register	201
4.4.2	DID—Device Identification Register	201
4.4.3	RID—Revision Identification Register	202
4.4.3.1	Stepping Revision ID (SRID)	203



4.4.3.2	Compatible Revision ID (CRID)	203
4.4.4	CCR—Class Code Register	204
4.4.5	HDR—Header Type Register	205
4.4.6	SVID—Subsystem Vendor Identification Register	205
4.4.7	SID—Subsystem Identity	206
4.4.8	PCICMD—Command Register	207
4.4.9	PCISTS—PCI Status Register	208
4.5	SAD—System Address Decoder Registers	209
4.5.1	SAD_PAM0123	209
4.5.2	SAD_PAM456	211
4.5.3	SAD_HEN	212
4.5.4	SAD_SMRAM	212
4.5.5	SAD_PCIEEXBAR	213
4.5.6	SAD_TPCIEXBAR	213
4.5.7	SAD_MCSEG_BASE	214
4.5.8	SAD_MCSEG_MASK	214
4.5.9	SAD_MESEG_BASE	215
4.5.10	SAD_MESEG_MASK	215
4.5.11	SAD_DRAM_RULE_0; SAD_DRAM_RULE_1 SAD_DRAM_RULE_2; SAD_DRAM_RULE_3 SAD_DRAM_RULE_4; SAD_DRAM_RULE_5 SAD_DRAM_RULE_6; SAD_DRAM_RULE_7	216
4.5.12	SAD_INTERLEAVE_LIST_0; SAD_INTERLEAVE_LIST_1 SAD_INTERLEAVE_LIST_2; SAD_INTERLEAVE_LIST_3 SAD_INTERLEAVE_LIST_4; SAD_INTERLEAVE_LIST_5 SAD_INTERLEAVE_LIST_6; SAD_INTERLEAVE_LIST_7	217
4.6	Intel® QuickPath Interconnect Link Registers	218
4.6.1	QPI_QPILCL_LO	218
4.7	Integrated Memory Controller Control Registers	220
4.7.1	MC_CONTROL	220
4.7.2	MC_SMI_DIMM_ERROR_STATUS	221
4.7.3	MC_SMI_CNTRL	221
4.7.4	MC_STATUS	222
4.7.5	MC_RESET_CONTROL	222
4.7.6	MC_CHANNEL_MAPPER	223
4.7.7	MC_MAX_DOD	223
4.7.8	MC_CFG_LOCK	224
4.7.9	MC_RD_CRDT_INIT	225
4.7.10	MC_CRDT_WR_THLD	226
4.8	TAD—Target Address Decoder Registers	227
4.8.1	TAD_DRAM_RULE_0; TAD_DRAM_RULE_1 TAD_DRAM_RULE_2; TAD_DRAM_RULE_3 TAD_DRAM_RULE_4; TAD_DRAM_RULE_5 TAD_DRAM_RULE_6; TAD_DRAM_RULE_7	227
4.8.2	TAD_INTERLEAVE_LIST_0; TAD_INTERLEAVE_LIST_1 TAD_INTERLEAVE_LIST_2; TAD_INTERLEAVE_LIST_3 TAD_INTERLEAVE_LIST_4; TAD_INTERLEAVE_LIST_5 TAD_INTERLEAVE_LIST_6; TAD_INTERLEAVE_LIST_7	228
4.9	Integrated Memory Controller Test Registers	229
4.9.1	Integrated Memory Controller Padscan	229
4.9.2	MC_DIMM_CLK_RATIO_STATUS	231
4.9.3	MC_DIMM_CLK_RATIO	232
4.9.4	MC_TEST_LTRCON	232
4.9.5	MC_TEST_PH_CTR	233
4.9.6	MC_TEST_PH_PIS	233
4.9.7	MC_TEST_PAT_GCTR	234
4.9.8	MC_TEST_PAT_BA	235

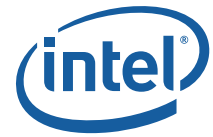

4.9.9	MC_TEST_PAT_IS.....	235
4.9.10	MC_TEST_PAT_DCD	235
4.9.11	MC_TEST_EP_SCCTL.....	236
4.9.12	MC_TEST_EP_SCD.....	236
4.10	Integrated Memory Controller Channel Control Registers	237
4.10.1	MC_CHANNEL_0_DIMM_RESET_CMD MC_CHANNEL_1_DIMM_RESET_CMD	237
4.10.2	MC_CHANNEL_0_DIMM_INIT_CMD MC_CHANNEL_1_DIMM_INIT_CMD	238
4.10.3	MC_CHANNEL_0_DIMM_INIT_PARAMS MC_CHANNEL_1_DIMM_INIT_PARAMS	239
4.10.4	MC_CHANNEL_0_DIMM_INIT_STATUS MC_CHANNEL_1_DIMM_INIT_STATUS	240
4.10.5	MC_CHANNEL_0_DDR3CMD MC_CHANNEL_1_DDR3CMD.....	241
4.10.6	MC_CHANNEL_0_REFRESH_THROTTLE_SUPPORT MC_CHANNEL_1_REFRESH_THROTTLE_SUPPORT	242
4.10.7	MC_CHANNEL_0_MRS_VALUE_0_1 MC_CHANNEL_1_MRS_VALUE_0_1	242
4.10.8	MC_CHANNEL_0_MRS_VALUE_2 MC_CHANNEL_1_MRS_VALUE_2	243
4.10.9	MC_CHANNEL_0_RANK_PRESENT MC_CHANNEL_1_RANK_PRESENT.....	244
4.10.10	MC_CHANNEL_0_RANK_TIMING_A MC_CHANNEL_1_RANK_TIMING_A	245
4.10.11	MC_CHANNEL_0_RANK_TIMING_B MC_CHANNEL_1_RANK_TIMING_B	247
4.10.12	MC_CHANNEL_0_BANK_TIMING MC_CHANNEL_1_BANK_TIMING.....	248
4.10.13	MC_CHANNEL_0_REFRESH_TIMING MC_CHANNEL_1_REFRESH_TIMING.....	248
4.10.14	MC_CHANNEL_0_CKE_TIMING MC_CHANNEL_1_CKE_TIMING	249
4.10.15	MC_CHANNEL_0_ZQ_TIMING MC_CHANNEL_1_ZQ_TIMING.....	250
4.10.16	MC_CHANNEL_0_RCOMP_PARAMS MC_CHANNEL_1_RCOMP_PARAMS.....	250
4.10.17	MC_CHANNEL_0_ODT_PARAMS1 MC_CHANNEL_1_ODT_PARAMS1	251
4.10.18	MC_CHANNEL_0_ODT_PARAMS2 MC_CHANNEL_1_ODT_PARAMS2.....	252
4.10.19	MC_CHANNEL_0_ODT_MATRIX_RANK_0_3_RD MC_CHANNEL_1_ODT_MATRIX_RANK_0_3_RD	252
4.10.20	MC_CHANNEL_0_ODT_MATRIX_RANK_4_7_RD MC_CHANNEL_1_ODT_MATRIX_RANK_4_7_RD	253
4.10.21	MC_CHANNEL_0_ODT_MATRIX_RANK_0_3_WR MC_CHANNEL_1_ODT_MATRIX_RANK_0_3_WR	253
4.10.22	MC_CHANNEL_0_ODT_MATRIX_RANK_4_7_WR MC_CHANNEL_1_ODT_MATRIX_RANK_4_7_WR	253
4.10.23	MC_CHANNEL_0_WAQ_PARAMS MC_CHANNEL_1_WAQ_PARAMS.....	254
4.10.24	MC_CHANNEL_0_SCHEDULER_PARAMS MC_CHANNEL_1_SCHEDULER_PARAMS.....	255
4.10.25	MC_CHANNEL_0_MAINTENANCE_OPS MC_CHANNEL_1_MAINTENANCE_OPS	255
4.10.26	MC_CHANNEL_0_TX_BG_SETTINGS MC_CHANNEL_1_TX_BG_SETTINGS.....	256
4.10.27	MC_CHANNEL_0_RX_BGF_SETTINGS MC_CHANNEL_1_RX_BGF_SETTINGS.....	257



4.10.28	MC_CHANNEL_0_EW_BGF_SETTINGS MC_CHANNEL_1_EW_BGF_SETTINGS.....	257
4.10.29	MC_CHANNEL_0_EW_BGF_OFFSET_SETTINGS MC_CHANNEL_1_EW_BGF_OFFSET_SETTINGS	258
4.10.30	MC_CHANNEL_0_ROUND_TRIP_LATENCY MC_CHANNEL_1_ROUND_TRIP_LATENCY.....	258
4.10.31	MC_CHANNEL_0_PAGETABLE_PARAMS1 MC_CHANNEL_1_PAGETABLE_PARAMS1	259
4.10.32	MC_CHANNEL_0_PAGETABLE_PARAMS2 MC_CHANNEL_1_PAGETABLE_PARAMS2	259
4.10.33	MC_TX_BG_CMD_DATA_RATIO_SETTINGS_CHO MC_TX_BG_CMD_DATA_RATIO_SETTINGS_CH1	260
4.10.34	MC_TX_BG_CMD_OFFSET_SETTINGS_CHO MC_TX_BG_CMD_OFFSET_SETTINGS_CH1.....	260
4.10.35	MC_TX_BG_DATA_OFFSET_SETTINGS_CHO MC_TX_BG_DATA_OFFSET_SETTINGS_CH1	260
4.11	Integrated Memory Controller Channel Address Registers.....	261
4.11.1	MC_DOD_CHO_0 MC_DOD_CHO_1	261
4.11.2	MC_DOD_CH1_0 MC_DOD_CH1_1	262
4.11.3	MC_SAG_CHO_0; MC_SAG_CHO_1; MC_SAG_CHO_2; MC_SAG_CHO_3; MC_SAG_CHO_4; MC_SAG_CHO_5; MC_SAG_CHO_6; MC_SAG_CHO_7.....	263
4.11.4	MC_SAG_CH1_0; MC_SAG_CH1_1; MC_SAG_CH1_2; MC_SAG_CH1_3; MC_SAG_CH1_4; MC_SAG_CH1_5; MC_SAG_CH1_6; MC_SAG_CH1_7.....	264
4.12	Integrated Memory Controller Channel Rank Registers.....	265
4.12.1	MC_RIR_LIMIT_CHO_0; MC_RIR_LIMIT_CHO_1; MC_RIR_LIMIT_CHO_2; MC_RIR_LIMIT_CHO_3; MC_RIR_LIMIT_CHO_4; MC_RIR_LIMIT_CHO_5; MC_RIR_LIMIT_CHO_6; MC_RIR_LIMIT_CHO_7	265
4.12.2	MC_RIR_LIMIT_CH1_0; MC_RIR_LIMIT_CH1_1; MC_RIR_LIMIT_CH1_2; MC_RIR_LIMIT_CH1_3; MC_RIR_LIMIT_CH1_4; MC_RIR_LIMIT_CH1_5; MC_RIR_LIMIT_CH1_6; MC_RIR_LIMIT_CH1_7	265
4.12.3	MC_RIR_WAY_CHO_0; MC_RIR_WAY_CHO_1; MC_RIR_WAY_CHO_2; MC_RIR_WAY_CHO_3; MC_RIR_WAY_CHO_4; MC_RIR_WAY_CHO_5 MC_RIR_WAY_CHO_6; MC_RIR_WAY_CHO_7 MC_RIR_WAY_CHO_8; MC_RIR_WAY_CHO_9 MC_RIR_WAY_CHO_10; MC_RIR_WAY_CHO_11 MC_RIR_WAY_CHO_12; MC_RIR_WAY_CHO_13 MC_RIR_WAY_CHO_14; MC_RIR_WAY_CHO_15 MC_RIR_WAY_CHO_16; MC_RIR_WAY_CHO_17 MC_RIR_WAY_CHO_18; MC_RIR_WAY_CHO_19 MC_RIR_WAY_CHO_20; MC_RIR_WAY_CHO_21 MC_RIR_WAY_CHO_22; MC_RIR_WAY_CHO_23 MC_RIR_WAY_CHO_24; MC_RIR_WAY_CHO_25 MC_RIR_WAY_CHO_26; MC_RIR_WAY_CHO_27 MC_RIR_WAY_CHO_28; MC_RIR_WAY_CHO_29 MC_RIR_WAY_CHO_30; MC_RIR_WAY_CHO_31	266
4.12.4	MC_RIR_WAY_CH1_0; MC_RIR_WAY_CH1_1 MC_RIR_WAY_CH1_2; MC_RIR_WAY_CH1_3 MC_RIR_WAY_CH1_4; MC_RIR_WAY_CH1_5 MC_RIR_WAY_CH1_6; MC_RIR_WAY_CH1_7 MC_RIR_WAY_CH1_8; MC_RIR_WAY_CH1_9 MC_RIR_WAY_CH1_10; MC_RIR_WAY_CH1_11 MC_RIR_WAY_CH1_12; MC_RIR_WAY_CH1_13 MC_RIR_WAY_CH1_14; MC_RIR_WAY_CH1_15 MC_RIR_WAY_CH1_16; MC_RIR_WAY_CH1_17 MC_RIR_WAY_CH1_18; MC_RIR_WAY_CH1_19 MC_RIR_WAY_CH1_20; MC_RIR_WAY_CH1_21 MC_RIR_WAY_CH1_22; MC_RIR_WAY_CH1_23 MC_RIR_WAY_CH1_24; MC_RIR_WAY_CH1_25	



	MC_RIR_WAY_CH1_26; MC_RIR_WAY_CH1_27	
	MC_RIR_WAY_CH1_28; MC_RIR_WAY_CH1_29	
	MC_RIR_WAY_CH1_30; MC_RIR_WAY_CH1_31	267
4.13	Memory Thermal Control	268
4.13.1	MC_THERMAL_CONTROLO	
	MC_THERMAL_CONTROL1	268
4.13.2	MC_THERMAL_STATUS0	
	MC_THERMAL_STATUS1	268
4.13.3	MC_THERMAL_DEFEATURE0	
	MC_THERMAL_DEFEATURE1	269
4.13.4	MC_THERMAL_PARAMS_A0	
	MC_THERMAL_PARAMS_A1	269
4.13.5	MC_THERMAL_PARAMS_B0	
	MC_THERMAL_PARAMS_B1	270
4.13.6	MC_COOLING_COEFO	
	MC_COOLING_COEF1	270
4.13.7	MC_CLOSED_LOOP0	
	MC_CLOSED_LOOP1	271
4.13.8	MC_THROTTLE_OFFSET0	
	MC_THROTTLE_OFFSET1	271
4.13.9	MC_RANK_VIRTUAL_TEMP0	
	MC_RANK_VIRTUAL_TEMP1	272
4.13.10	MC_DDR_THERM_COMMAND0	
	MC_DDR_THERM_COMMAND1	272
4.13.11	MC_DDR_THERM_STATUS0	
	MC_DDR_THERM_STATUS1	273
5	System Address Map	275
5.1	Introduction	275
5.2	Memory Address Space	276
5.2.1	System Address Map	277
5.2.2	System DRAM Memory Regions	278
5.2.3	VGA/SMM and Legacy C/D/E/F Regions	279
5.2.3.1	VGA/SMM Memory Space	279
5.2.3.2	C/D/E/F Segments	280
5.2.4	Address Region between 1 MB and TOLM	280
5.2.4.1	Relocatable TSEG	281
5.2.5	Address Region from TOLM to 4 GB	281
5.2.5.1	PCI Express® Memory Mapped Configuration Space	281
5.2.5.2	MMIOL	282
5.2.5.3	Miscellaneous	282
5.2.5.4	Processor Local CSR, On-die ROM, and Processor PSeg	282
5.2.5.5	Legacy/HPET/TXT/TPM/Others	282
5.2.5.6	Local XAPIC	283
5.2.5.7	High BIOS Area	283
5.2.5.8	INTA/Rsvd	283
5.2.5.9	Firmware	283
5.2.6	Address Regions above 4 GB	284
5.2.6.1	High System Memory	284
5.2.6.2	Memory Mapped IO High	284
5.2.6.3	BIOS Notes on Address Allocation above 4 GB	285
5.2.7	Protected System DRAM Regions	285
5.3	IO Address Space	285
5.3.1	VGA I/O Addresses	285
5.3.2	ISA Addresses	286
5.3.3	CFC/CF8 Addresses	286
5.3.4	PCIe Device I/O Addresses	286
5.4	Configuration/CSR Space	286
5.4.1	PCIe Configuration Space	286



5.5	System Management Mode (SMM)	287
5.5.1	SMM Space Definition	287
5.5.2	SMM Space Restrictions	288
5.5.3	SMM Space Combinations	288
5.5.4	SMM Control Combinations	289
5.5.5	SMM Space Decode and Transaction Handling	289
5.5.6	Processor WB Transaction to an Enabled SMM Address Space	289
5.5.7	SMM Access Through GTT TLB	289
5.6	Memory Shadowing	290
5.7	IIO Address Map Notes	290
5.7.1	Memory Recovery	290
5.7.2	Non-Coherent Address Space	290
5.8	IIO Address Decoding	291
5.8.1	Outbound Address Decoding	291
5.8.1.1	General Overview	291
5.8.1.2	FWH Decoding	292
5.8.1.3	Other Outbound Target Decoding	292
5.8.1.4	Summary of Outbound Target Decoder Entries	293
5.8.1.5	Summary of Outbound Memory/IO/Configuration Decoding	293
5.8.2	Inbound Address Decoding	295
5.8.2.1	Overview	295
5.8.2.2	Summary of Inbound Address Decoding	296
5.8.3	Intel® VT-d Address Map Implications	300



Figures

2-1	Memory Map to PCI Express* Device Configuration Space.....	22
2-2	Processor Configuration Cycle Flowchart	23
3-1	DMI Port (Device 0) and PCI Express* Root Ports Type 1 Configuration Space	29
3-2	Base Address of Intel® VT-d Remap Engines	137
4-1	Padscan Accessibility Mechanism	230
5-1	System address Map.....	277
5-2	VGA/SMM and Legacy C/D/E/F Regions	279
5-3	Pre-allocated Memory Example for 64 MB DRAM, 1 MB VGA, 1 MB GTT Stolen and 1 MB TSEG	281

Tables

3-1	Functions Handled by the Processor Integrated I/O (IIO)	28
3-2	Device 0 (DMI) Configuration Map	31
3-3	Device 0 (DMI) Extended Configuration Map	32
3-4	Device 3,5 PCI Express* Registers Legacy Configuration Map	33
3-5	Device 3,5 PCI Express* Registers Extended Configuration Map	34
3-6	DMI RCRB Registers	84
3-7	Core Registers (Device 8, Function 0) — Offset 000h–0FFh	92
3-8	Core Registers (Device 8, Function 0) — Offset 100h–1FFh	93
3-9	Core Registers (Device 8, Function 1) — Semaphore and ScratchPad Registers (Sheet 1 of 2)	94
3-10	Core Registers (Device 8, Function 1) — Semaphore and ScratchPad Registers (Sheet 2 of 2)	95
3-11	Core Registers (Device 8, Function 2) — System Control/Status Registers.....	96
3-12	Core Registers (Device 8, Function 3) — Miscellaneous Registers	97
3-13	Intel® VT-d Memory Mapped Registers — 00h–FFh, 1000h–10FFh	138
3-14	Intel® VT-d Memory Mapped Registers — 100h–1FFh, 1100h–11FFh.....	139
3-15	Intel® Trusted Execution Technology Registers.....	157
3-16	Intel® Trusted Execution Technology Registers, cont'd	158
3-17	Intel® Trusted Execution Technology Registers, cont'd	159
3-18	Intel® Trusted Execution Technology Registers, cont'd	160
3-19	Intel® Trusted Execution Technology Registers, cont'd	161
3-20	Intel® QuickPath Interconnect Physical/Link Map Port 0 (Device 16).....	176
3-21	CSR Intel® QuickPath Interconnect Routing Layer, Protocol (Device 16, Function 1) .	180
4-1	Functions Specifically Handled by the Processor.....	184
4-2	Device 0, Function 0 — Generic Non-core Registers	185
4-3	Device 0, Function 1 — System Address Decoder Registers	186
4-4	Device 2, Function 0 — Intel® QuickPath Interconnect Link 0 Registers	187
4-5	Device 2, Function 1 — Intel® QuickPath Interconnect Physical 0 Registers	188
4-6	Device 3, Function 0 — Integrated Memory Controller Registers	189
4-7	Device 3, Function 1 — Target Address Decoder Registers	190
4-8	Device 3, Function 2 — Memory Controller Test Registers	191
4-9	Device 3, Function 4 — Integrated Memory Controller Test Registers.....	192
4-10	Device 4, Function 0 — Integrated Memory Controller Channel 0 Control Registers.....	193
4-11	Device 4, Function 1 — Integrated Memory Controller Channel 0 Address Registers.....	194
4-12	Device 4, Function 2 — Integrated Memory Controller Channel 0 Rank Registers.....	195



4-13	Device 4, Function 3 — Integrated Memory Controller Channel 0 Thermal Control Registers.....	196
4-14	Device 5, Function 0 — Integrated Memory Controller Channel 1 Control Registers.....	197
4-15	Device 5, Function 1 — Integrated Memory Controller Channel 1 Address Registers.....	198
4-16	Device 5, Function 2 — Integrated Memory Controller Channel 1 Rank Registers.....	199
4-17	Device 5, Function 3 — Integrated Memory Controller Channel 1 Thermal Control Registers.....	200
4-18	Padscan Accessible Parameters.....	229
4-19	Scan Chains.....	229
4-20	Halt and Mask Bit Usage.....	230
4-21	Padscan Registers.....	230
5-1	Transaction Address Ranges – Compatible, High, and TSEG.....	287
5-2	SMM Space Table.....	288
5-3	SMM Control Table.....	289
5-4	Outbound Target Decoder Entries.....	293
5-5	Decoding of Outbound Memory Requests from Intel® QuickPath Interconnect (from processor or remote Peer-to-Peer).....	293
5-6	Decoding of Outbound Configuration Requests (from Processor or Peer-to- Peer) from Intel® QuickPath Interconnect and Decoding of Outbound Peer-to-Peer Completions from Intel QuickPath Interconnect.....	294
5-7	Subtractive Decoding of Outbound I/O Requests from Intel® QuickPath Interconnect	294
5-8	Inbound Memory Address Decoding.....	296
5-9	Inbound I/O Address Decoding.....	298
5-10	Inbound Configuration Request Decoding.....	299



Revision History

Revision Number	Description	Revision Date
-001	Initial release	September 2009

§



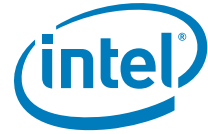

1 Introduction

This is Volume 2 of the Datasheet for the Intel® Core™ i7-800 and i5-700 desktop processor series.

The processor contains one or more PCI devices within a single physical component. The configuration registers for these devices are mapped as devices residing on the PCI Bus assigned for the processor socket. This document describes these configuration space registers or device-specific control and status registers (CSRs) only. This document does NOT include Model Specific Registers (MSRs).

Note: Throughout this document, the Intel® Core™ i7-800 and i5-700 desktop processor series may be referred to as “processor”.

Note: Throughout this document, the Intel® 5 series Chipset Platform Controller Hub Platform Controller Hub is also referred to as “PCH”.

Note: The term “DT” refers to desktop platforms.

1.1 Register Terminology

Registers and register bits are assigned one or more of the following attributes. These attributes define the behavior of register and the bit(s) that are contained within. All bits are set to default values by hard reset. Sticky bits retain their states between hard resets.

Term	Description
RO	Read Only. If a register bit is read only, the hardware sets its state. The bit may be read by software. Writes to this bit have no effect.
WO	Write Only. The register bit is not implemented as a bit. The write causes some hardware event to take place.
RWO	Read/Write Once. These bits can be read by software. After reset, these bits can only be written by software once, after which the bits becomes 'Read Only'.
RW	Read/Write. A register bit with this attribute can be read and written by software.
RC	Read Clear. The bit or bits can be read by software, but the act of reading causes the value to be cleared.
RCW	Read Clear/Write. A register bit with this attribute will get cleared after the read. The register bit can be written.
RW1C	Read/Write 1 Clear. A register bit with this attribute can be read or cleared by software. In order to clear this bit, a one must be written to it. Writing a zero will have no effect.
RW0C	Read/Write 0 Clear. A register bit with this attribute can be read or cleared by software. In order to clear this bit, a zero must be written to it. Writing a one will have no effect.
ROS	RO Sticky. These bits can only be read by software, writes have no effect. The value of the bits is determined by the hardware only. These bits are only re-initialized to their default value by a PWRGOOD reset.
RWS	R/W Sticky. These bits can be read and written by software. These bits are only re-initialized to their default value by a PWRGOOD reset.
RW1S	Read/Write 1 Set. A register bit can be either read or set by software. In order to set this bit, a one must be written to it. Writing a zero to this bit has no effect. Hardware will clear this bit.
RW0S	Read/Write 0 Set. A register bit can be either read or set by software. In order to set this bit, a zero must be written to it. Writing a one to this bit has no effect. Hardware will clear this bit.
RWL	Read/Write/Lock. A register bit with this attribute can be read or written by software. Hardware or a configuration bit can lock the bit and prevent it from being updated.

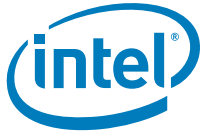

Term	Description
RWO	Read/Write Once. A register bit with this attribute can be written to only once after power up. After the first write, the bit becomes read only. This attribute is applied on a bit by bit basis. For example, if the RWO attribute is applied to a 2-bit field, and only one bit is written, then the written bit cannot be rewritten (unless reset). The unwritten bit, of the field, may still be written once. This is special case of RWL.
RWDS	RW and Sticky. Re-initialized to default value only with POWERGOOD reset. Value written will take effect on the next Link layer init.
RRW	Read/Restricted Write. This bit can be read and written by software. However, only supported values will be written. Writes of non supported values will have no effect.
L	Lock. A register bit with this attribute becomes Read Only after a lock bit is set.
RSVD/RV	Reserved Bit. This bit is reserved for future expansion and must not be written. The latest version of the <i>PCI Local Bus Specification</i> , requires that reserved bits must be preserved. Any software that modifies a register that contains a reserved bit is responsible for reading the register, modifying the desired bits, and writing back the result.
Reserved Bits	Some of the processor registers described in this section contain reserved bits. These bits are labeled "Reserved". Software must deal correctly with fields that are reserved. On reads, software must use appropriate masks to extract the defined bits and not rely on reserved bits being any particular value. On writes, software must ensure that the values of reserved bit positions are preserved. That is, the values of reserved bit positions must first be read, merged with the new values for other bit positions and then written back. Note that software does not need to perform a read-merge-write operation for the Configuration Address (CONFIG_ADDRESS) register.
Reserved Registers	In addition to reserved bits within a register, the processor contains address locations in the configuration space that are marked either "Reserved" or "Intel Reserved". The processor responds to accesses to "Reserved" address locations by completing the host cycle. When a "Reserved" register location is read, a zero value is returned. ("Reserved" registers can be 8, 16, or 32 bits in size). Writes to "Reserved" registers have no effect on the processor. Registers that are ®marked as "Intel Reserved" must not be modified by system software. Writes to "Intel Reserved" registers may cause system failure. Reads to "Intel Reserved" registers may return a non-zero value.
Default Value upon a Reset	Upon a reset, the processor sets all of its internal configuration registers to predetermined default states. Some register values at reset are determined by external strapping options. The default state represents the minimum functionality feature set required to successfully bring up the system. Hence, it does not represent the optimal system configuration. It is the responsibility of the system initialization software (usually BIOS) to properly determine the DRAM configurations, operating parameters and optional system features that are applicable, and to program the processor registers accordingly.
"ST" appended to the end of a bit name	The bit is "sticky" or unchanged by a hard reset. These bits can only be cleared by a PWRGOOD reset.

§



2 Configuration Process and Registers

2.1 Platform Configuration Structure

The DMI physically connects the processor and the Intel Platform Controller Hub (PCH). From a configuration standpoint, the DMI is logically PCI Bus 0. A physical PCI Bus 0 does not exist. DMI and the internal devices in the processor Integrated I/O (IIO) and Intel PCH logically constitute PCI Bus 0 to configuration software. As a result, all devices internal to the processor and the Intel PCH appear to be on PCI Bus 0.

The system primary PCI expansion bus is physically attached to the Intel PCH and, from a configuration perspective, appears to be a hierarchical PCI bus behind a PCI-to-PCI bridge and, therefore, has a programmable PCI Bus number. The PCI Express* Graphics Attach appears to system software to be a real PCI bus behind a PCI-to-PCI bridge that is a device resident on PCI Bus 0.

Devices residing in the Processor Uncore appear on PCI Bus FFh. There is a programmable base bus number that determines the top bus number to start top down processor socket to PCI bus mapping. The processors default to 255 as the top bus number. However, this top bus number can be redefined by the SAD_PCIEXBAR CSR (Bus: FFh, Device 0, Function 1, Register offset 50h).

2.1.1 Processor Integrated I/O (IIO) Devices (PCI Bus 0)

The processor IIO contains the following PCI devices within a single, physical component. The configuration registers for the devices are mapped as devices residing on PCI Bus 0.

- **Device 0** — DMI Root Port. Logically this appears as a PCI device residing on PCI Bus 0. Device 0 contains the standard PCI header registers, extended PCI configuration registers and DMI device specific configuration registers.
- **Device 3** — PCI Express Root Port 1. Logically this appears as a “virtual” PCI-to-PCI bridge residing on PCI Bus 0 and is compliant with the *PCI Express Local Bus Specification Revision 1.0*. Device 3 contains the standard PCI Express/PCI configuration registers including PCI Express Memory Address Mapping registers. It also contains the extended PCI Express configuration space that includes PCI Express error status/control registers and Isochronous and Virtual Channel controls.
- **Device 5** — PCI Express Root Port 3. Logically this appears as a “virtual” PCI-to-PCI bridge residing on PCI Bus 0 and is compliant with *PCI Express Local Bus Specification Revision 1.0*. Device 5 contains the standard PCI Express/PCI configuration registers including PCI Express Memory Address Mapping registers. It also contains the extended PCI Express configuration space that include PCI Express error status/control registers and Isochronous and Virtual Channel controls.
- **Device 8** — Integrated I/O Core. This device contains the Standard PCI registers for each of its functions. This device implements four functions; Function 0 contains Address Mapping, Intel® Virtualization Technology (Intel® VT) for Directed I/O (Intel VT-d) related registers and other system management registers. Function 1 contains Semaphore and Scratchpad registers, Function 3 contains System

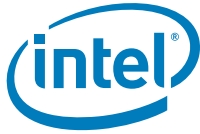

Control/Status registers and Function 4 contains miscellaneous control/status registers on power management and throttling.

- **Device 16** — Intel® QuickPath Interconnect. Device 16, Function 0 contains the Intel® QuickPath Interconnect configuration registers for Intel QuickPath Interconnect Link. Device 16, Function 1 contains the routing and protocol.

2.1.2 Processor Uncore Devices (PCI Bus — FFh)

The processor Uncore contains the following devices within a single, physical component. The configuration registers for these devices are mapped as devices residing on the PCI bus assigned for the processor socket. Bus number is derived by the maximum bus range setting and processor socket number.

- **Device 0** — Generic processor non-core. Device 0, Function 0 contains the generic non-core configuration registers for the processor and resides at DID (Device ID) of 2C50-7h. Device 0, Function 1 contains the System Address Decode registers and resides at DID of 2C81h.
- **Device 2** — Intel QuickPath Interconnect. Device 2, Function 0 contains the Intel QuickPath Interconnect configuration registers for Intel QuickPath Interconnect Link 0 and resides at DID of 2C90h. Device 2, Function 1 contains the physical layer registers for Intel QuickPath Interconnect Link 0 and resides at DID of 2C91h.
- **Device 3** — Integrated Memory Controller. Device 3, Function 0 contains the general registers for the Integrated Memory Controller and resides at DID of 2C98h. Device 3, Function 1 contains the Target Address Decode registers for the Integrated Memory Controller and resides at DID of 2C99h. Device 3, Function 4 contains the test registers for the Integrated Memory Controller and resides at DID of 2C9C.
- **Device 4** — Integrated Memory Controller Channel 0. Device 4, Function 0 contains the control registers for Integrated Memory Controller Channel 0 and resides at DID of 2CA0h. Device 4, Function 1 contains the address registers for Integrated Memory Controller Channel 0 and resides at DID of 2CA1h. Device 4, Function 2 contains the rank registers for Integrated Memory Controller Channel 0 and resides at DID of 2CA2h. Device 4, Function 3 contains the thermal control registers for Integrated Memory Controller Channel 0 and resides at DID of 2CA3h.
- **Device 5** — Integrated Memory Controller Channel 1. Device 5, Function 0 contains the control registers for Integrated Memory Controller Channel 1 and resides at DID of 2CA8h. Device 5, Function 1 contains the address registers for Integrated Memory Controller Channel 1 and resides at DID of 2CA9h. Device 5, Function 2 contains the rank registers for Integrated Memory Controller Channel 1 and resides at DID of 2CAAh. Device 5, Function 3 contains the thermal control registers for Integrated Memory Controller Channel 1 and resides at DID of 2CABh.



2.2 Configuration Mechanisms

The processor is the originator of configuration cycles. Internal to the processor transactions received through both of the below configuration mechanisms are translated to the same format.

2.2.1 Standard PCI Express* Configuration Mechanism

The following is the mechanism for translating processor I/O bus cycles to configuration cycles.

The PCI specification defines a slot based "configuration space" that allows each device to contain up to eight functions, with each function containing up to 256, 8-bit configuration registers. The PCI specification defines two bus cycles to access the PCI configuration space: Configuration Read and Configuration Write. Memory and I/O spaces are supported directly by the processor. Configuration space is supported by a mapping mechanism implemented within the processor.

The configuration access mechanism makes use of the CONFIG_ADDRESS Register (at I/O address 0CF8h through 0CFBh) and CONFIG_DATA Register (at I/O address 0CFCh through 0CFh). To reference a configuration register, a DW I/O write cycle is used to place a value into CONFIG_ADDRESS that specifies the PCI bus, the device on that bus, the function within the device and a specific configuration register of the device function being accessed. CONFIG_ADDRESS[31] must be 1 to enable a configuration cycle. CONFIG_DATA then becomes a window into the four bytes of configuration space specified by the contents of CONFIG_ADDRESS. Any read or write to CONFIG_DATA will result in the processor translating the CONFIG_ADDRESS into the appropriate configuration cycle.

The processor is responsible for translating and routing the processor's I/O accesses to the CONFIG_ADDRESS and CONFIG_DATA registers to internal processor configuration registers, DMI, or PCI Express.

2.2.2 PCI Express* Configuration Mechanism

PCI Express extends the configuration space to 4096 bytes per device/function as compared to 256 bytes allowed by PCI Specification Revision 2.3. PCI Express configuration space is divided into a PCI 2.3 compatible region, which consists of the first 256 bytes of a logical device's configuration space and a PCI Express extended region that consists of the remaining configuration space.

The PCI-compatible region can be accessed using either the Standard PCI Configuration Mechanism or using the PCI Express Enhanced Configuration Mechanism described in this section. The extended configuration registers may only be accessed using the PCI Express Enhanced Configuration Mechanism. To maintain compatibility with PCI configuration addressing mechanisms, system software must access the extended configuration space using 32-bit operations (32-bit aligned) only. These 32-bit operations include byte enables allowing only appropriate bytes within the DWord to be accessed. Locked transactions to the PCI Express memory mapped configuration address space are not supported. All changes made using either access mechanism are equivalent.

The PCI Express Enhanced Configuration Mechanism utilizes a flat memory-mapped address space to access device configuration registers. This address space is reported by the system firmware to the operating system. The register, SAD_PCIEXBAR defines

the base address for the block of addresses below 4 GB for the configuration space associated with busses, devices and functions that are potentially a part of the PCI Express root complex hierarchy. In the SAD_PCIEXBAR register there exists controls to limit the size of this reserved memory mapped space. 256 MB is the amount of address space required to reserve space for every bus, device, and function that could possibly exist. Options for 128 MB and 64 MB exist in order to free up those addresses for other uses. In these cases the number of busses and all of their associated devices and functions are limited to 128 or 64 busses, respectively.

The PCI Express Configuration Transaction Header includes an additional four bits (ExtendedRegisterAddress[3:0]) between the Function Number and Register Address fields to provide indexing into the 4 KB of configuration space allocated to each potential device. For PCI Compatible Configuration Requests, the Extended Register Address field must be all zeros.

Figure 2-1. Memory Map to PCI Express* Device Configuration Space

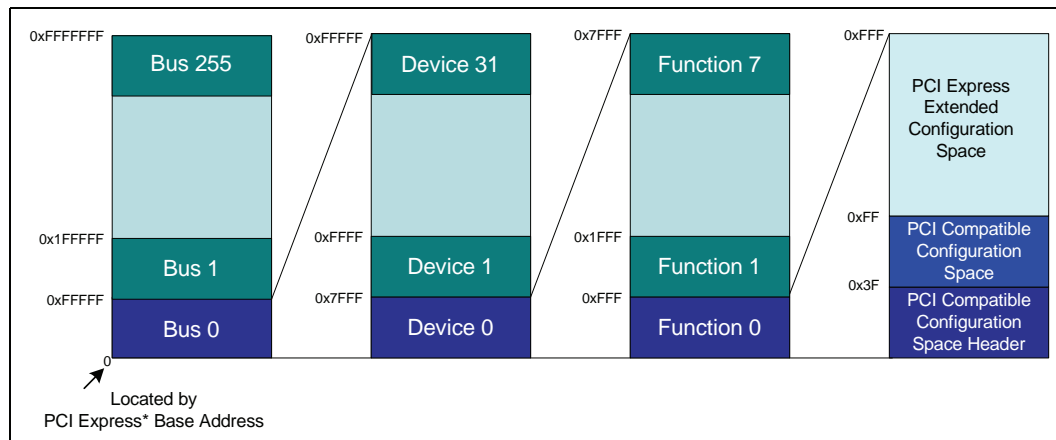

As with PCI devices, each device is selected based on decoded address information that is provided as a part of the address portion of Configuration Request packets. A PCI Express device will decode all address information fields (bus, device, function and extended address numbers) to provide access to the correct register.

To access this space (step 1 is done only once by BIOS),

1. Write to CSR address 01050h to enable the PCI Express enhanced configuration mechanism by writing 1 to Bit 0 of the SAD_PCIEXBAR register. Allocate either 256, 128, or 64 busses to PCI Express by writing "000", "111", or "110," respectively, to Bits 3:1. Pick a naturally aligned base address for mapping the configuration space onto memory space using 1 MB per bus number and write that base address into Bits 39:20.
2. Calculate the host address of the register you wish to set using (PCI Express base + (bus number * 1 MB) + (device number * 32 KB) + (function number * 4 KB) + (1 B * offset within the function) = host address).
3. Use a memory write or memory read cycle to the calculated host address to write or read that register.

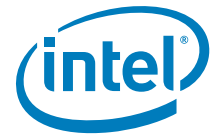

2.3 Routing Configuration Accesses

The processor supports two PCI related interfaces: DMI and PCI Express. The processor is responsible for routing PCI and PCI Express configuration cycles to the appropriate device that is an integrated part of the processor or to one of these two interfaces. Configuration cycles to the PCH internal devices and Primary PCI (including downstream devices) are routed to the PCH using DMI. Configuration cycles to both the PCI Express Graphics PCI compatibility configuration space and the PCI Express Graphics extended configuration space are routed to the PCI Express Graphics port device or associated link.

Figure 2-2. Processor Configuration Cycle Flowchart

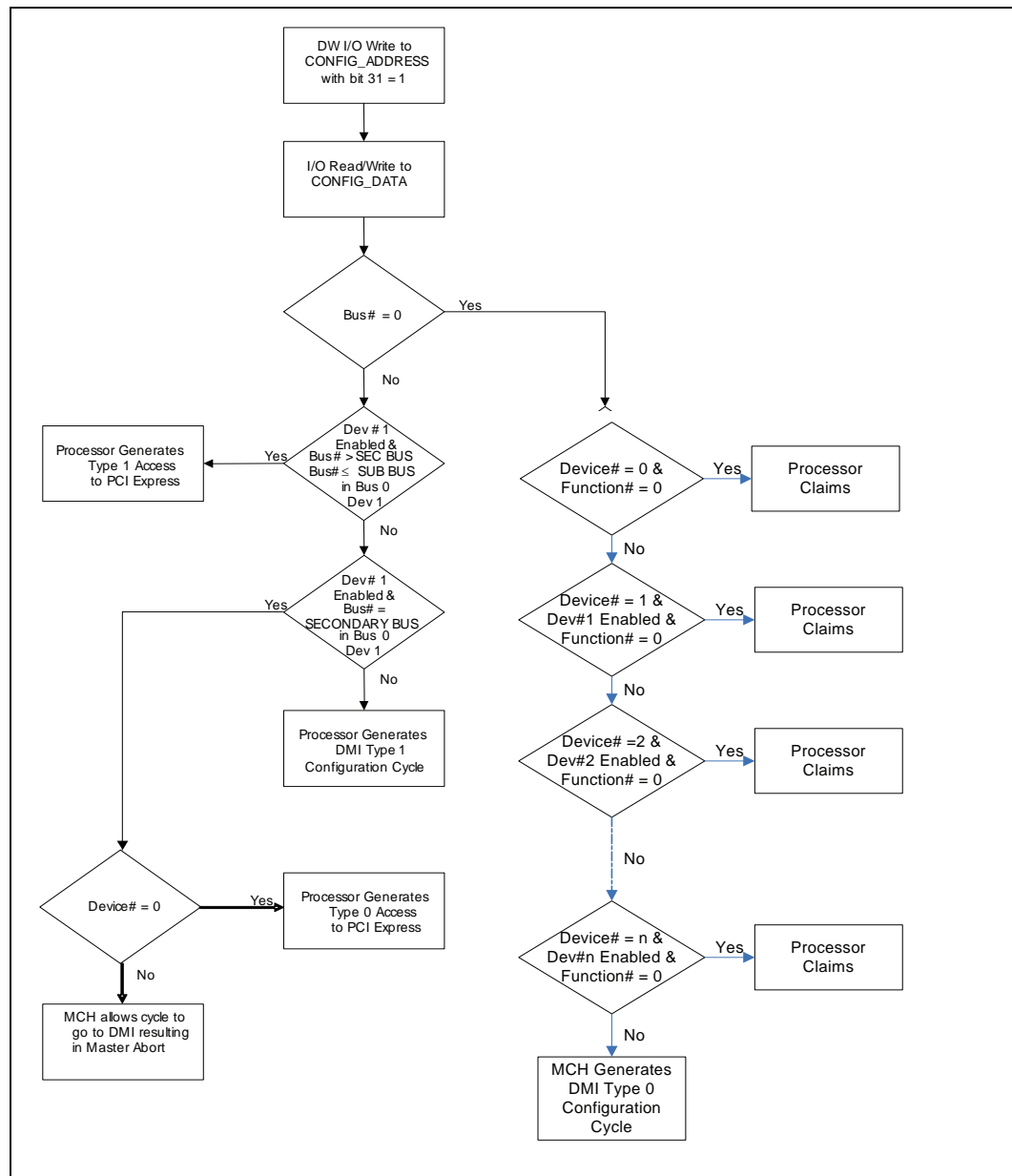



2.3.1 Internal Device Configuration Accesses

The processor decodes the Bus Number (Bits 23:16) and the Device Number fields of the CONFIG_ADDRESS register. If the Bus Number field of CONFIG_ADDRESS is 0, the configuration cycle is targeting a PCI Bus 0 device.

If the targeted PCI Bus 0 device exists in the processor and is not disabled, the configuration cycle is claimed by the appropriate device.

2.3.2 Bridge-Related Configuration Accesses

Configuration accesses on PCI Express or DMI are PCI Express Configuration Transaction Layer Packets (TLPs).

- Bus Number [7:0] is Header Byte 8 [7:0]
- Device Number [4:0] is Header Byte 9 [7:3]
- Function Number [2:0] is Header Byte 9 [2:0]

And special fields for this type of TLP:

- Extended Register Number [3:0] is Header Byte 10 [3:0]
- Register Number [5:0] is Header Byte 11 [7:2]

See the *PCI Express Specification* for more information on both the PCI 2.3 compatible and PCI Express Enhanced Configuration Mechanism and transaction rules.

2.3.2.1 PCI Express* Configuration Accesses

When the Bus Number of a Type 1 Standard PCI Configuration cycle or PCI Express Enhanced Configuration access matches the Device 1 Secondary Bus Number a PCI Express Type 0 Configuration TLP is generated on the PCI Express link targeting the device directly on the opposite side of the link. This should be Device 0 on the bus number assigned to the PCI Express link (likely Bus 1).

The device on other side of link must be Device 0. The processor will Master Abort any Type 0 Configuration access to a non-zero Device number. If there is to be more than one device on that side of the link there must be a bridge implemented in the downstream device.

When the Bus Number of a Type 1 Standard PCI Configuration cycle or PCI Express Enhanced Configuration access is within the claimed range (between the upper bound of the bridge device's Subordinate Bus Number register and the lower bound of the bridge device's Secondary Bus Number register) but doesn't match the Device 1 Secondary Bus Number, a PCI Express Type 1 Configuration TLP is generated on the secondary side of the PCI Express link.

PCI Express Configuration Writes:

- The processor will translate writes to PCI Express extended configuration space to configuration writes on the backbone internally.
- Posted writes to extended space are non-posted on the PCI Express or DMI (that is, translated to configuration writes).

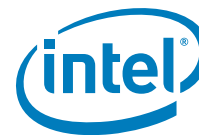

2.3.2.2 DMI Configuration Accesses

Accesses to disabled processor internal devices, bus numbers not claimed by the Host-PCI Express bridge, or PCI Bus 0 devices not part of the processor will subtractively decode to the PCH and consequently be forwarded over the DMI using a PCI Express configuration TLP. In [Figure 2-2](#), the subtractive decode is completed by testing Devices 0 through n, where Devices 0 through n, if enabled and Function 0 is present in the processor are claimed by the processor.

If the Bus Number is zero, the processor will generate a Type 0 Configuration Cycle TLP on DMI. If the Bus Number is non-zero, and falls outside the range claimed by the Host-PCI Express bridge, the processor will generate a Type 1 Configuration Cycle TLP on DMI.

The PCH routes configurations accesses in a manner similar to the processor. The PCH decodes the configuration TLP and generates a corresponding configuration access. Accesses targeting a device on PCI Bus 0 may be claimed by an internal device. The PCH compares the non-zero Bus Number with the Secondary Bus Number and Subordinate Bus Number registers of its PCI-to-PCI bridges to determine if the configuration access is meant for Primary PCI, or some other downstream PCI bus or PCI Express link.

Configuration accesses that are forwarded to the PCH, but remain unclaimed by any device or bridge will result in a master abort.

2.4 Processor Register Introduction

The processor contains two sets of software accessible registers – control registers and internal configuration registers:

- Control registers are I/O mapped into the processor I/O space. These registers control access to PCI and PCI Express configuration space (see [Section 2.5](#), I/O Mapped Registers).
- Internal configuration registers residing within the processor are partitioned into the device register sets as indicated in [Section 2.1.1](#) and [Section 2.1.2](#).

The processor internal registers (I/O Mapped, Configuration and PCI Express Extended Configuration registers) are accessible by the Host processor. The registers that reside within the lower 256 bytes of each device can be accessed as byte, word (16 bit), or DWord (32 bit) quantities, with the exception of CONFIG_ADDRESS, which can only be accessed as a DWord. All multi-byte numeric fields use "little-endian" ordering (that is, lower addresses contain the least significant parts of the field). Registers that reside in bytes 256 through 4095 of each device may only be accessed using memory mapped transactions in DWord (32 bit) quantities.

Some of the processor registers described in this section contain reserved bits; these bits are labeled "Reserved". Software must not modify reserved fields. On reads, software must use appropriate masks to extract the defined bits and not rely on reserved bits being any particular value. On writes, software must ensure that the values of reserved bit positions are preserved. That is, the values of reserved bit positions must first be read, merged with the new values for other bit positions and then written back. Note that the software does not need to perform read, merge, and write operation for the Configuration Address Register.

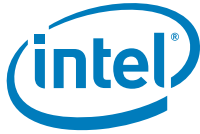

In addition to reserved bits within a register, the processor contains address locations in the configuration space of the Host Bridge entity that are marked either "Reserved" or "Intel Reserved". The processor responds to accesses to "Reserved" address locations by completing the host cycle. When a "Reserved" register location is read, a zero value is returned. ("Reserved" registers can be 8, 16, or 32 bits in size). Registers that are marked as "Intel Reserved" must not be modified by system software. Writes to "Intel Reserved" registers may cause system failure. Reads from "Intel Reserved" registers may return a non-zero value.

Upon a Full Reset, the processor sets its entire set of internal configuration registers to predetermined default states. Some register values at reset are determined by external strapping options. The default state represents the minimum functionality feature set required to successfully bring up the system. Hence, it does not represent the optimal system configuration. It is the responsibility of the system initialization software (usually BIOS) to properly determine the DRAM configurations, operating parameters, and optional system features that are applicable, and to program the processor registers accordingly.

2.5 I/O Mapped Registers

The processor contains two registers that reside in the processor I/O address space – the Configuration Address (CONFIG_ADDRESS) Register and the Configuration Data (CONFIG_DATA) Register. The Configuration Address Register enables/disables the configuration space and determines what portion of configuration space is visible through the Configuration Data window.

§



3 Processor Integrated I/O (IIO) Configuration Registers

3.1 Processor IIO Devices (PCI Bus 0)

The processor Integrated I/O (IIO) contains the following PCI devices within a single, physical component. The configuration registers for the devices are mapped as devices residing on PCI Bus 0.

- **Device 0** — DMI Root Port. Logically this appears as a PCI device residing on PCI Bus 0. Device 0 contains the standard PCI header registers, extended PCI configuration registers and DMI device specific configuration registers.
- **Device 3** — PCI Express Root Port 1. Logically this appears as a “virtual” PCI-to-PCI bridge residing on PCI Bus 0 and is compliant with the *PCI Express Local Bus Specification Revision 1.0*. Device 3 contains the standard PCI Express/PCI configuration registers including PCI Express Memory Address Mapping registers. It also contains the extended PCI Express configuration space that include PCI Express error status/control registers and Isochronous and Virtual Channel controls.
- **Device 5** — PCI Express Root Port 3. Logically this appears as a “virtual” PCI-to-PCI bridge residing on PCI Bus 0 and is compliant with *PCI Express Local Bus Specification Revision 1.0*. Device 5 contains the standard PCI Express/PCI configuration registers including PCI Express Memory Address Mapping registers. It also contains the extended PCI Express configuration space that include PCI Express error status/control registers and Isochronous and Virtual Channel controls.
- **Device 8** — Integrated I/O Core. This device contains the Standard PCI registers for each of its functions. This device implements four functions; Function 0 contains Address Mapping, Intel VT-d related registers and other system management registers. Function 1 contains Semaphore and Scratchpad registers. Function 3 contains System Control/Status registers. Function 4 contains miscellaneous control/status registers on power management and throttling.
- **Device 16** — Intel QuickPath Interconnect. Device 16, Function 0 contains the Intel QuickPath Interconnect configuration registers for Intel QuickPath Interconnect Link. Device 16, Function 1 contains the routing and protocol.



3.2 Device Mapping

All devices on the Integrated I/O Module reside on PCI Bus 0. Table 3-1 describes the devices and functions that the integrated I/O (IIO) module implements or routes specifically.

Table 3-1. Functions Handled by the Processor Integrated I/O (IIO)

Register Group	DID	Device	Function	Comment
DMI	D131h = DT	0	0	
PCI Express Root Port 1	D138h	3	0	x16 or x8 max link width
PCI Express Root Port 3	D13Ah	5	0	x8 max link width
Core	D155h	8	0	Address mapping, Intel VT-d, System Management
Core	D156h	8	1	Semaphore and Scratchpad registers
Core	D157h	8	2	System control/status registers
Core	D158h	8	3	Miscellaneous registers
Intel QuickPath Interconnect Port	D150h	16	0	Intel QuickPath Interconnect Link
Intel QuickPath Interconnect Port	D151h	16	1	Intel QuickPath Interconnect Routing and Protocol

3.2.1 Unimplemented Devices/Functions and Registers

Configuration reads to unimplemented functions and devices will return all ones emulating a master abort response. There is no asynchronous error reporting when a configuration read master aborts. Configuration writes to unimplemented functions and devices will return a normal response to Intel QuickPath Interconnect.

Software should not attempt or rely on reads or writes to unimplemented registers or register bits. Software should also not attempt to modify Reserved bits or any unused bits called out specifically. Unimplemented registers return all zeroes when read. Writes to unimplemented registers are ignored. For configuration writes to these registers, the completion is returned with a normal completion status (not master-aborted).

3.3 PCI Express*/DMI Configuration Registers

This section covers the configuration space registers for PCI Express and DMI. The first part of this section describes the standard PCI header space from 0h to 3Fh. The second part describes the device specific region from 40h to FFh. The third part describes the PCI Express enhanced configuration region.

3.3.1 Other Register Notes

Note that in general, all register bits in the standard PCI header space (offset 0h–3Fh) or in any OS-visible capability registers, that control the address decode like MSE, IOSE, VGAEN or otherwise control transaction forwarding must be treated as dynamic bits in the sense that these register bits could be changed by the OS when there is traffic flowing through the IIO. Note that the address register themselves can be

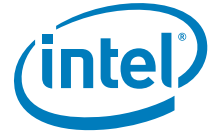

treated as static in the sense that they will not be changed without the decode control bits being clear. Registers outside of this standard space will be noted as dynamic when appropriate.

3.3.2 Configuration Register Map

Figure 3-1. DMI Port (Device 0) and PCI Express* Root Ports Type 1 Configuration Space

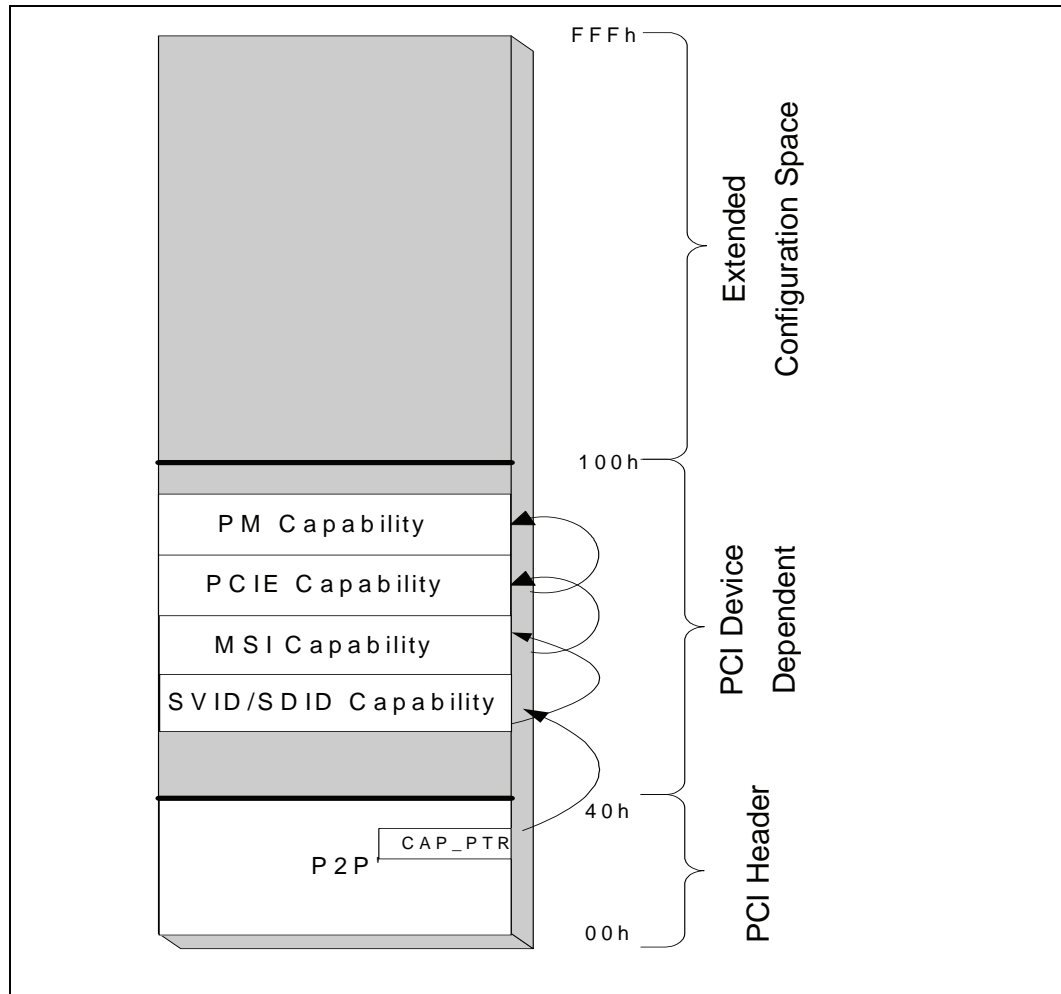



Figure 3-1 illustrates how each PCI Express port's configuration space appears to software. Each PCI Express configuration space has three regions:

- **Standard PCI Header** — This region is the standard PCI-to-PCI bridge header providing legacy OS compatibility and resource management.
- **PCI Device Dependent Region** — This region is also part of standard PCI configuration space and contains the PCI capability structures and other port specific registers. For the IIO, the supported capabilities are:
 - SVID/SDID Capability
 - Message Signalled Interrupts
 - Power Management
 - PCI Express Capability
- **PCI Express Extended Configuration Space** — This space is an enhancement beyond standard PCI and only accessible with PCI Express aware software.

Note that all the capabilities listed above for a PCI Express port are required for a DMI port. Through the rest of the chapter, as each register is elaborated, it will be noted which registers are applicable to the PCI Express port and which are applicable to the DMI port.



Table 3-2. Device 0 (DMI) Configuration Map

DID		VID		00h		80h		
PCISTS		PCICMD		04h		84h		
CCR			RID	08h		88h		
	HDR	PLAT	CLSR	0Ch		8Ch		
				10h	PEGCAP	PEGNXPTR	PEGCAPID	90h
				14h	DEVCAP			94h
				18h	DEVSTS	DEVCTRL		98h
				1Ch	LNKCAP			9Ch
				20h	LNKSTS	LNKCON		A0h
				24h				A4h
				28h				A8h
SID		SVID		2Ch	ROOTCAP	ROOTCON	ACH	
				30h	ROOTSTS		B0h	
				CAPPTR	34h	DEVCAP2		B4h
					38h		DEVCTRL2	B8h
	INTPIN	INTLIN		3Ch			BCh	
				40h		LNKCON2	C0h	
				44h				C4h
				48h				C8h
				4Ch				CCh
DMIRCBAR				50h			D0h	
				54h			D4h	
				58h			D8h	
				5Ch			DCh	
				MSICTL		MSINXPTR	MSICAPID	60h
MSIAR				64h	PMCSR		E4h	
	MSIDR			68h			E8h	
MSIMSK				6Ch			ECh	
MSIPENDING				70h			F0h	
				74h			F4h	
				78h			F8h	
				7Ch			FCh	

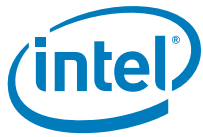

Table 3-3. Device 0 (DMI) Extended Configuration Map

	100h	PERFCTRLSTS	180h	
	104h		184h	
	108h	MISCCTRLSTS	188h	
	10Ch		18Ch	
	110h		190h	
	114h		194h	
	118h		198h	
	11Ch		19Ch	
	120h		1A0h	
	124h		1A4h	
	128h		1A8h	
	12Ch		1ACh	
	130h		1B0h	
	134h		1B4h	
138h	1B8h			
13Ch	1BCh			
APICLIMIT	APICBASE	140h	1C0h	
	144h		1C4h	
	148h		1C8h	
	14Ch		1CCh	
	150h		1D0h	
	154h		1D4h	
	158h		1D8h	
	15Ch		1DCh	
	160h		CTOCTRL	1E0h
	164h			1E4h
	168h			1E8h
	16Ch			1ECh
	170h			1F0h
174h	1F4h			
178h	1F8h			
17Ch	1FCh			

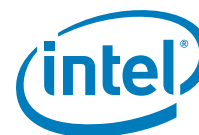

Table 3-4. Device 3,5 PCI Express* Registers Legacy Configuration Map

DID	VID			00h				80h
PCISTS	PCICMD			04h				84h
CCR		RID		08h				88h
HDR	PLAT	CLSR		0Ch				8Ch
				10h	PEGCAP	PEGNXPTR	PEGCAPID	90h
				14h	DEVCAP			94h
SUBBUS		SECBUS	PBUS	18h	DEVSTS	DEVCTRL		98h
SECSTS	IOLIM	IOBAS		1Ch	LNKCAP			9Ch
MLIM	MBAS			20h	LNKSTS	LNKCON		A0h
PMLIMIT	PMBASE			24h	SLTCAP			A4h
PMBASEU				28h	SLTSTS	SLTCON		A8h
PMLIMITU				2Ch	ROOTCAP	ROOTCON		ACH
				30h	ROOTSTS			B0h
				34h	DEVCAP2			B4h
				38h		DEVCTRL2		B8h
BCTRL	INTPIN	INTLIN		3Ch				BCh
	SNXPTR	SCAPID		40h	LNKSTS2	LNKCON2		C0h
SID	SVID			44h				C4h
				48h				C8h
				4Ch				CCh
				50h				D0h
				54h				D4h
				58h				D8h
5Ch	DCh							
MSICTRL	MSINXPTR	MSICAPID		60h	PMCAP			E0h
MSIAR				64h	PMCSR			E4h
	MSIDR			68h				E8h
MSIMSK				6Ch				ECh
MSIPENDING				70h				F0h
				74h				F4h
				78h	F8h			
				7Ch	FCh			



Table 3-5. Device 3,5 PCI Express* Registers Extended Configuration Map

		100h	PERFCTRLSTS	180h		
		104h		184h		
				108h	MISCCTRLSTS	188h
				10Ch		18Ch
				110h		190h
				114h		194h
				118h		198h
				11Ch		19Ch
				120h		1A0h
				124h		1A4h
				128h		1A8h
				12Ch		1ACh
				130h		1B0h
134h	1B4h					
138h	1B8h					
13Ch	1BCh					
APICLIMIT	APICBASE			140h		
		144h		1C4h		
		148h		1C8h		
		14Ch		1CCh		
		150h		1D0h		
		154h		1D4h		
		158h		1D8h		
		15Ch		1DCh		
				160h	CTOCTRL	1E0h
				164h		1E4h
				168h		1E8h
				16Ch		1ECh
				170h		1F0h
				174h		1F4h
178h				1F8h		
17Ch				1FCh		

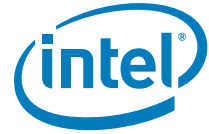

3.3.3 Standard PCI Configuration Space (0h to 3Fh) — Type 0/1 Common Configuration Space

This section covers registers in the 0h to 3Fh region that are common to devices 0, 3,5.

Comments at the top of the table indicate what devices/functions the description applies to. Exceptions that apply to specific functions are noted in the individual bit descriptions.

3.3.3.1 VID—Vendor Identification Register

Register: VID Device: 0, 3,5 Function: 0 Offset: 00h			
Bit	Attr	Default	Description
15:0	RO	8086h	Vendor Identification Number (VID) PCI Standard Identification for Intel.

3.3.3.2 DID—Device Identification Register

Register: DID Device: 0, 3,5 Function: 0 Offset: 02h			
Bit	Attr	Default	Description
15:0	RO	See Table 3-1	Device Identification Number Identifier assigned to the product.



3.3.3.3 PCI_CMD—PCI Command Register

This register defines the PCI 3.0 compatible command register values applicable to PCI Express space.

Register: PCI_CMD Device: 0 (DMI) Function: 0 Offset: 04h			
Bit	Attr	Default	Description
15:11	RV	00h	<i>Reserved</i>
10	RW	0	Legacy Interrupt Mode Enable/Disable
9	RO	0	Fast Back-to-Back Enable Not applicable. Hardwired to 0.
8	RW	0	SERR Enable For PCI Express/DMI ports, this field enables notifying the internal core error logic of occurrence of an uncorrectable error (fatal or non-fatal) at the port. The internal core error logic of Integrated I/O then decides if/how to escalate the error further (pins/message, and so forth). This bit also controls the propagation of PCI Express ERR_FATAL and ERR_NONFATAL messages received from the port to the internal Integrated I/O core error logic. 0 = Fatal and Non-fatal error generation and Fatal and Non-fatal error message forwarding is disabled 1 = Fatal and Non-fatal error generation and Fatal and Non-fatal error message forwarding is enabled Refer to the latest <i>PCI Express Base Specification</i> for details of how this bit is used in conjunction with other control bits in the Root Control register for forwarding errors detected on the PCI Express interface to the system core error logic.
7	RO	0	IDSEL Stepping/Wait Cycle Control Not applicable to Processor Integrated I/O devices. Hardwired to 0.
6	RW	0	Parity Error Response For PCI Express/DMI ports, Processor Integrated I/O ignores this bit and always does ECC/parity checking and signaling for data/address of transactions both to and from IIO. This bit though affects the setting of Bit 8 in the PCISTS register.
5	RO	0	VGA Palette Snoop Enable Not applicable to Processor Integrated I/O devices. Hardwired to 0.
4	RO	0	Memory Write and Invalidate Enable Not applicable to Processor Integrated I/O devices. Hardwired to 0.
3	RO	0	Special Cycle Enable Not applicable. Hardwired to 0.
2	RO	0	Bus Master Enable (BME) For Device 0 (DMI), this bit is hardwired to 0 since the DMI is not a PCI-to-PCI bridge. Hardware should ignore the functionality of this bit.
1	RO	0	Memory Space Enable (MSE) For Device 0 (DMI), this bit is hardwired to 0 since the DMI is not a PCI-to-PCI bridge.
0	RO	0	IO Space Enable (IOSE) For Device 0 (DMI), this bit is hardwired to 0 since the DMI is not a PCI-to-PCI bridge.

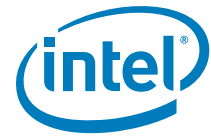

(Sheet 1 of 2)

Bit	Attr	Default	Description
Register: PCICMD Device: 3,5 (PCIe*) Function: 0 Offset: 04h			
15:11	RV	00h	<i>Reserved (by PCI SIG)</i>
10	RW	0	Legacy Interrupt Mode Enable/Disable
9	RO	0	Fast Back-to-Back Enable Not applicable to PCI Express and is hardwired to 0.
8	RW	0	SERR Enable For PCI Express/DMI ports, this field enables notifying the internal core error logic of occurrence of an uncorrectable error (fatal or non-fatal) at the port. The internal core error logic of IIO then decides if/how to escalate the error further (pins/message, and so forth). This bit also controls the propagation of PCI Express ERR_FATAL and ERR_NONFATAL messages received from the port to the internal IIO core error logic. 0 = Fatal and Non-fatal error generation and Fatal and Non-fatal error message forwarding is disabled. 1 = Fatal and Non-fatal error generation and Fatal and Non-fatal error message forwarding is enabled. Refer to the latest <i>PCI Express Base Specification</i> for details of how this bit is used in conjunction with other control bits in the Root Control register for forwarding errors detected on the PCI Express interface to the system core error logic.
7	RO	0	IDSEL Stepping/Wait Cycle Control Not applicable to Processor Integrated I/O devices. Hardwired to 0.
6	RW	0	Parity Error Response For PCI Express/DMI ports, Processor Integrated I/O ignores this bit and always does ECC/parity checking and signaling for data/address of transactions both to and from Integrated I/O.
5	RO	0	VGA Palette Snoop Enable Not applicable to Processor Integrated I/O devices. Hardwired to 0.
4	RO	0	Memory Write and Invalidate Enable Not applicable to Processor Integrated I/O devices. Hardwired to 0.
3	RO	0	Special Cycle Enable Not applicable to PCI Express. Hardwired to 0.
2	RW	0	Bus Master Enable (BME) This bit controls the ability of the PCI Express port in generating/forwarding memory (including MSI writes) or I/O transactions (and not messages) or configuration transactions from the secondary side to the primary side. 0 = The Bus Master is disabled. When this bit is 0, Integrated I/O root ports will treat upstream PCI Express memory writes/reads, I/O writes/reads, and configuration reads and writes as unsupported requests (and follow the rules for handling unsupported requests). This behavior is also true towards transactions that are already pending in the Integrated I/O root port's internal queues when the BME bit is turned off. 1 = Enables the PCI Express ports to generate/forward memory, configuration, or I/O read/write requests.



(Sheet 2 of 2)

Register: PCICMD Device: 3,5 (PCIe*) Function: 0 Offset: 04h			
Bit	Attr	Default	Description
1	RW	0	Memory Space Enable (MSE) 0 = Disables a PCI Express port's memory range registers (including the CSR range registers) to be decoded as valid target addresses for transactions from primary side. 1 = Enables a PCI Express port's memory range registers to be decoded as valid target addresses for transactions from primary side. Note that if a PCI Express port's MSE bit is clear, that port can still be target of any memory transaction if subtractive decoding is enabled on that port.
0	RW	0	IO Space Enable (IOSE) Applies to PCI Express ports 0 = Disables the I/O address range, defined in the IOBASE and IOLIM registers of the PCI-to-PCI bridge header, for target decode from primary side. 1 = Enables the I/O address range, defined in the IOBASE and IOLIM registers of the PCI-to-PCI bridge header, for target decode from primary side. Note that if a PCI Express port's IOSE bit is clear, that port can still be target of an I/O transaction if subtractive decoding is enabled on that port.

3.3.3.4 PCISTS—PCI Status Register

The PCI Status register is a 16-bit status register that reports the occurrence of various events associated with the primary side of the “virtual” PCI-to-PCI bridge embedded in PCI Express ports and also primary side of the other devices on the internal Processor Integrated I/O bus.

(Sheet 1 of 2)

Register: PCISTS Device: 0 (DMI), 3,5 (PCIe) Function: 0 Offset: 06h			
Bit	Attr	Default	Description
15	RW1C	0	Detected Parity Error This bit is set by a device when it receives a packet on the primary side with an uncorrectable data error or an uncorrectable address/control parity error. The setting of this bit is regardless of the Parity Error Response bit (PERRE) in the PCICMD register.
14	RW1C	0	Signaled System Error 0 = The device did not report a fatal/non-fatal error. 1 = The device reported fatal/non-fatal (and not correctable) errors it detected on its PCI Express* interface through a message to the PCH, with SERRE bit enabled. Software clears this bit by writing a 1 to it. For PCI Express ports, this bit is also set (when SERR enable bit is set) when a FATAL/NON-FATAL message is forwarded from the Express link to the PCH using a message.



(Sheet 2 of 2)

Register: PCISTS Device: 0 (DMI), 3,5 (PCIe) Function: 0 Offset: 06h			
Bit	Attr	Default	Description
13	RW1C	0	<p>Received Master Abort Status</p> <p>This bit is set when a device experiences a master abort condition on a transaction it mastered on the primary interface (Integrated I/O internal bus). Note that certain errors might be detected right at the PCI Express interface and those transactions might not “propagate” to the primary interface before the error is detected (for example, accesses to memory above TOCM in cases where the PCI Express* interface logic itself might have visibility into TOCM). Such errors do not cause this bit to be set, and are reported using the PCI Express interface error bits (secondary status register). Conditions that cause Bit 13 to be set, include:</p> <ul style="list-style-type: none"> • Device receives a completion on the primary interface (internal bus of Integrated I/O) with Unsupported Request or master abort completion Status. This includes UR status received on the primary side of a PCI Express port on peer-to-peer completions also. • Device accesses to holes in the main memory address region that are detected by Intel QuickPath Interconnect Source Address Decoder. • Other master abort conditions detected on the Integrated I/O internal bus.
12	RW1C	0	<p>Received Target Abort</p> <p>This bit is set when a device experiences a completer abort condition on a transaction it mastered on the primary interface (Integrated I/O internal bus). Note that certain errors might be detected right at the PCI Express interface and those transactions might not propagate to the primary interface before the error is detected (for example, accesses to memory above VTCSRBASE). Such errors do not cause this bit to be set, and are reported using the PCI Express interface error bits (secondary status register). Conditions that cause Bit 12 to be set, include:</p> <ul style="list-style-type: none"> • Device receives a completion on the primary interface (internal bus of Integrated I/O) with completer abort completion Status. This includes CA status received on the primary side of a PCI Express port on peer-to-peer completions also. • Accesses to Intel QuickPath Interconnect that return a failed completion status. • Other completer abort conditions detected on the Integrated I/O internal bus.
11	RW1C	0	<p>Signaled Target Abort</p> <p>This bit is set when a device signals a completer abort completion status on the primary side (internal bus of Integrated I/O). This condition includes a PCI Express port forwarding a completer abort status received on a completion from the secondary side and passed to the primary side on a peer-to-peer completion.</p>
10:9	RO	0h	<p>DEVSEL# Timing</p> <p>Not applicable to PCI Express. Hardwired to 0.</p>
8	RW1C	0	<p>Master Data Parity Error</p> <p>This bit is set by a device if the Parity Error Response bit in the PCI Command register is set and it receives a completion with poisoned data from the primary side or if it forwards a packet with data (including MSI writes) to the primary side with poison.</p>
7	RO	0	<p>Fast Back-to-Back</p> <p>Not applicable to PCI Express. Hardwired to 0.</p>
6	RO	0	<i>Reserved</i>
5	RO	0	<p>66-MHz Capable</p> <p>Not applicable to PCI Express. Hardwired to 0.</p>
4	RO	1	<p>Capabilities List</p> <p>This bit indicates the presence of a capabilities list structure.</p>
3	RO	0	<i>Reserved</i>
2:0	RO	0h	<i>Reserved</i>

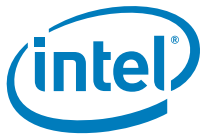

3.3.3.5 RID—Revision Identification Register

This register contains the revision number of the Integrated I/O.

Register: RID Device: 0 (DMI), 3,5 (PCIe) Function: 0 Offset: 08h			
Bit	Attr	Default	Description
7:4	RWO	See Description	Minor Revision Steppings that required all masks be regenerated. Refer to the <i>Intel® Core™ i7-800 and i5-700 Desktop Processor Series Specification Update</i> for the value of the Revision ID Register.
3:0	RWO	See Description	Minor Revision Identification Number Increment for each steppings that do not require masks to be regenerated. Refer to the <i>Intel® Core™ i7-800 and i5-700 Desktop Processor Series Specification Update</i> for the value of the Revision ID Register.

3.3.3.6 CCR—Class Code Register

This register contains the Class Code for the device.

Register: CCR Device: 0 Function: 0 Offset: 09h			
Bit	Attr	Default	Description
23:16	RO	06h	Base Class For DMI port, this field is hardwired to 06h, indicating it is a “Bridge Device.”
15:8	RO	00h	Sub-Class For Device 0 (DMI), this field defaults to 00h to indicate a “Host Bridge.”
7:0	RO	00h	Register-Level Programming Interface This field is hardwired to 00h for DMI port.

Register: CCR Device: 3,5 (PCIe) Function: 0 Offset: 09h			
Bit	Attr	Default	Description
23:16	RO	06h	Base Class For PCI Express ports this field is hardwired to 06h, indicating it is a “Bridge Device.”
15:8	RO	See Description	Sub-Class For PCI Express ports, this field defaults to 04h indicating “PCI-to-PCI bridge”. This register changes to the sub class of 00h to indicate “Host Bridge,” when bit 0 in “MISCCTRLSTS—Misc Control and Status Register” is set.
7:0	RO	00h	Register-Level Programming Interface This field is hardwired to 00h for PCI Express ports.

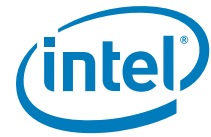

3.3.3.7 CLSR—Cacheline Size Register

Register: CLSR Device: 0 (DMI), 3,5 (PCIe) Function: 0 Offset: 0Ch			
Bit	Attr	Default	Description
7:0	RW	0h	Cacheline Size This register is set as RW for compatibility reasons only. Cacheline size for Integrated I/O is always 64B. Hardware ignores this setting.

3.3.3.8 PLAT—Primary Latency Timer

Register: PLAT Device: 0 (DMI), 3,5 (PCIe) Function: 0 Offset: 0Dh			
Bit	Attr	Default	Description
7:0	RO	00h	Prim_Lat_timer: Primary Latency Timer Not applicable to PCI Express*. Hardwired to 00h.

The above register denotes the maximum time slice for a burst transaction in legacy PCI 2.3 on the primary interface. It does not affect/influence PCI Express functionality.

3.3.3.9 HDR—Header Type Register

This register identifies the header layout of the configuration space.

Register: HDR Device: 0 (DMI) Function: 0 Offset: 0Eh			
Bit	Attr	Default	Description
7	RO	0	Multi-Function Device This bit defaults to 0 for PCI Express*/DMI ports.
6:0	RO	00h	Configuration Layout This field identifies the format of the configuration header layout. For Device 0 (DMI), default is 00h indicating a conventional type 00h PCI header.

Register: HDR Device: 3,5 (PCIe) Function: 0 Offset: 0Eh			
Bit	Attr	Default	Description
7	RO	0	Multi-Function Device This bit defaults to 0 for PCI Express*/DMI ports.
6:0	RO	01h	Configuration Layout This field identifies the format of the configuration header layout. It is Type 1 for all PCI Express ports. The default is 01h, indicating a PCI-to-PCI bridge.



3.3.3.10 SVID—Subsystem Vendor ID

This register identifies the vendor of the subsystem. This 16-bit register combined with the Device Identification Register uniquely identify any PCI device.

Register: SVID Device: 0 (DMI) Function: 0 Offset: 2Ch			
Bit	Attr	Default	Description
15:0	RWO	8086h	Subsystem Vendor Identification This field is programmed during boot-up to indicate the vendor of the system board. After it has been written once, it becomes read only.

3.3.3.11 SID—Subsystem Identity

This register identifies the particular subsystem.

Register: SID Device: 0 (DMI) Function: 0 Offset: 2Eh			
Bit	Attr	Default	Description
15:0	RWO	00h	Subsystem Identification Number Assigned by the subsystem vendor to uniquely identify the subsystem.

3.3.3.12 CAPPTR—Capability Pointer

The CAPPTR provides the offset to the location of the first device capability in the capability list.

Register: CAPPTR Device: 0 (DMI), 3,5 (PCIe) Function: 0 Offset: 34h			
Bit	Attr	Default	Description
7:0	RWO	40h	Capability Pointer Points to the first capability structure for the device.

3.3.3.13 INTLIN—Interrupt Line Register

The Interrupt Line register is used to communicate interrupt line routing information between initialization code and the device driver. The device itself does not use this value. OS and device drivers use this to determine priority and vector information.

Register: INTLIN Device: 0 (DMI), 3,5 (PCIe) Function: 0 Offset: 3Ch			
Bit	Attr	Default	Description
7:0	RW	00h	Interrupt Line This bit is RW for devices that can generate a legacy INTx message and is needed only for compatibility purposes.

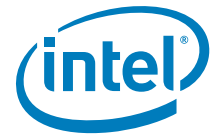

3.3.3.14 INTPIN—Interrupt Pin Register

The INTP register identifies legacy interrupts for INTA, INTB, INTC, and INTD as determined by BIOS/firmware.

Register: INTPIN Device: 0 (DMI), 3,5 (PCIe) Function: 0 Offset: 3Dh			
Bit	Attr	Default	Description
7:0	RWO	01h	INTP: Interrupt Pin This field defines the type of interrupt to generate for the PCI Express port. 001 = Generate INTA 010 = Generate INTB 011 = Generate INTC 100 = Generate INTD Others = Reserved BIOS/configuration Software has the ability to program this register once during boot to set up the correct interrupt for the port.

3.3.3.15 PBUS—Primary Bus Number Register

This register identifies the bus number on the on the primary side of the PCI Express port.

Register: PBUS Device: 3,5 (PCIe) Function: 0 Offset: 18h			
Bit	Attr	Default	Description
7:0	RW	00h	Primary Bus Number Configuration software programs this field with the number of the bus on the primary side of the bridge. BIOS must program this register to the correct value since Integrated I/O hardware would depend on this register for inbound decode purposes.

3.3.3.16 SECBUS—Secondary Bus Number

This register identifies the bus number assigned to the secondary side (PCI Express) of the “virtual” PCI-to-PCI bridge. This number is programmed by the PCI configuration software to allow mapping of configuration cycles to devices connected to PCI Express.

Register: SECBUS Device: 3,5 (PCIe) Function: 0 Offset: 19h			
Bit	Attr	Default	Description
7:0	RW	00h	Secondary Bus Number This field is programmed by configuration software to assign a bus number to the secondary bus of the virtual PCI-to-PCI bridge.



3.3.3.17 SUBBUS—Subordinate Bus Number Register

This register identifies the subordinate bus (if any) that resides at the level below the secondary bus of the PCI Express interface. This number is programmed by the PCI configuration software to allow mapping of configuration cycles to devices subordinate to the secondary PCI Express port.

Register: SUBBUS Device: 3,5 (PCIe) Function: 0 Offset: 1Ah			
Bit	Attr	Default	Description
7:0	RW	00h	Subordinate Bus Number This register is programmed by configuration software with the number of the highest subordinate bus that is behind the PCI Express* port. Any transaction that falls between the secondary and subordinate bus number (both inclusive) of an Express port is forwarded to the express port.

3.3.3.18 IOBAS—I/O Base Register

The I/O Base register defines an address range that is used by the PCI Express port to determine when to forward I/O transactions from one interface to the other using the following formula:

$$IO_BASE \leq A[15:12] \leq IO_LIMIT$$

The bottom of the defined I/O address range will be aligned to a 4-KB (1-KB if EN1K bit is set. Refer to the IOMISCCTRL register for the definition of EN1K bit) boundary while the top of the region specified by IO_LIMIT will be one less than a 4-KB (1-KB if EN1K bit is set) multiple. Setting the I/O limit less than I/O base disables the I/O range altogether.

Register: IOBAS Device: 3,5 (PCIe) Function: 0 Offset: 1Ch			
Bit	Attr	Default	Description
7:4	RW	0h	I/O Base Address Corresponds to A[15:12] of the I/O addresses at the PCI Express* port.
3:2	RWL	0h	When EN1K is set (Refer to IOMISCCTRL register for definition of EN1K bit), these bits become RW and allow for 1-K granularity of I/O addressing; otherwise, these are RO.
1:0	RO	0h	I/O Address Capability Integrated I/O supports only 16-bit addressing

Note: In general, the I/O base register will not be programmed by software without clearing the IOSE bit first.

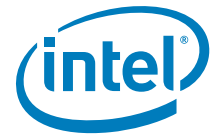

3.3.3.19 IOLIM—I/O Limit Register

The I/O Base register defines an address range that is used by the PCI Express port to determine when to forward I/O transactions from one interface to the other using the following formula:

$$IO_BASE \leq A[15:12] \leq IO_LIMIT$$

The bottom of the defined I/O address range will be aligned to a 4-KB (1-KB if EN1K bit is set. Refer to IOMISCCTRL register for definition of EN1K bit) boundary while the top of the region specified by IO_LIMIT will be one less than a 4-KB (1-KB if EN1K bit is set) multiple. Setting the I/O limit less than I/O base disables the I/O range altogether.

Register: IOLIM Device: 3,5 (PCIe) Function: 0 Offset: 1Dh			
Bit	Attr	Default	Description
7:4	RW	0h	I/O Address Limit Corresponds to A[15:12] of the I/O addresses at the PCI Express* port.
3:2	RWL	0h	When EN1K is set, these bits become RW and allow for 1-K granularity of I/O addressing, otherwise these bits are RO.
1:0	RO	0h	I/O Address Limit Capability IIO only supports 16-bit addressing.

Note: In general, the I/O limit register will not be programmed by software without clearing the IOSE bit first.



3.3.3.20 SECSTS—Secondary Status Register

Secondary Status register is a 16-bit status register that reports the occurrence of various events associated with secondary side (that is, PCI Express/DMI side) of the “virtual” PCI-to-PCI bridge.

Register: SECSTS Device: 3,5 (PCIe) Function: 0 Offset: 1Eh			
Bit	Attr	Default	Description
15	RW1C	0	Detected Parity Error This bit is set by the Integrated I/O whenever it receives a poisoned TLP in the PCI Express* port. This bit is set regardless of the state the Parity Error Response Enable bit in the Bridge Control register.
14	RW1C	0	Received System Error This bit is set by the Integrated I/O when it receives a ERR_FATAL or ERR_NONFATAL message.
13	RW1C	0	Received Master Abort Status This bit is set when the PCI Express port receives a Completion with “Unsupported Request Completion” Status or when IIO master aborts a Type 0 configuration packet that has a non-zero device number.
12	RW1C	0	Received Target Abort Status This bit is set when the PCI Express port receives a Completion with “Completer Abort” Status.
11	RW1C	0	Signaled Target Abort This bit is set when the PCI Express port sends a completion packet with a “Completer Abort” Status (including peer-to-peer completions that are forwarded from one port to another).
10:9	RO	00	DEVSEL# Timing Not applicable to PCI Express. Hardwired to 0.
8	RW1C	0	Master Data Parity Error This bit is set by the PCI Express port on the secondary side (PCI Express link) if the Parity Error Response Enable bit (PERRE) is set in Bridge Control register and either of the following two conditions occurs: <ul style="list-style-type: none"> • The PCI Express port receives a Completion from PCI Express marked poisoned. • The PCI Express port poisons a packet with data. If the Parity Error Response Enable bit in Bridge Control Register is cleared, this bit is never set.
7	RO	0	Fast Back-to-Back Transactions Capable Not applicable to PCI Express. Hardwired to 0.
6	RO	0	<i>Reserved</i>
5	RO	0	66-MHz Capability Not applicable to PCI Express. Hardwired to 0.
4:0	RO	0h	<i>Reserved</i>

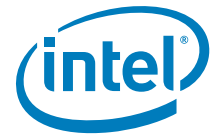

3.3.3.21 MBAS—Memory Base

The Memory Base and Memory Limit registers define a memory-mapped I/O non-prefetchable address range (32-bit addresses) and the Integrated I/O directs accesses in this range to the PCI Express port based on the following formula:

$$\text{MEMORY_BASE} \leq A[31:20] \leq \text{MEMORY_LIMIT}$$

The upper 12 bits of both the Memory Base and Memory Limit registers are read/write and corresponds to the upper 12 address bits, A[31:20] of 32-bit addresses. Thus, the bottom of the defined memory address range will be aligned to a 1-MB boundary and the top of the defined memory address range will be one less than a 1-MB boundary.

Register: MBAS Device: 3,5 (PCIe) Function: 0 Offset: 20h			
Bit	Attr	Default	Description
15:4	RW	0h	Memory Base Address This field corresponds to A[31:20] of the memory address on the PCI Express* port.
3:0	RO	0h	<i>Reserved</i>

Setting the memory limit less than memory base disables the 32-bit memory range altogether.

Note: In general, the memory base and limit registers will not be programmed by software without clearing the MSE bit first.

3.3.3.22 MLIM—Memory Limit

Register: MLIM Device: 3,5 (PCIe) Function: 0 Offset: 22h			
Bit	Attr	Default	Description
15:4	RW	0h	Memory Limit Address This field corresponds to A[31:20] of the memory address that corresponds to the upper limit of the range of memory accesses that will be passed by the PCI Express* bridge
3:0	RO	0h	<i>Reserved (by PCI-SIG)</i>

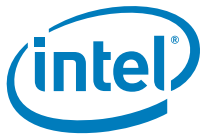

3.3.3.23 PMBASE—Prefetchable Memory Base Register

The Prefetchable Memory Base and Memory Limit registers define a memory mapped I/O prefetchable address range (64-bit addresses) which is used by the PCI Express bridge to determine when to forward memory transactions based on the following formula:

$$\text{PREFETCH_MEMORY_BASE_UPPER}::\text{PREFETCH_MEMORY_BASE} \leq A[63:20] \leq \text{PREFETCH_MEMORY_LIMIT_UPPER}::\text{PREFETCH_MEMORY_LIMIT}$$

The upper 12 bits of both the Prefetchable Memory Base and Memory Limit registers are read/write and correspond to the upper 12 address bits, A[31:20] of the 32-bit addresses. The bottom of the defined memory address range will be aligned to a 1-MB boundary and the top of the defined memory address range will be one less than a 1-MB boundary.

Register: PMBASE Device: 3,5 (PCIe) Function: 0 Offset: 24h			
Bit	Attr	Default	Description
15:4	RW	000h	Prefetchable Memory Base Address This field corresponds to A[31:20] of the prefetchable memory address on the PCI Express* port.
3:0	RO	1h	Prefetchable Memory Base Address Capability Integrated I/O sets this bit to 01h to indicate 64-bit capability.

The bottom 4 bits of both the Prefetchable Memory Base and Prefetchable Memory Limit registers are read-only, contain the same value, and encode whether or not the bridge supports 64-bit addresses. If these four bits have the value 0h, then the bridge supports only 32-bit addresses. If these four bits have the value 01h, then the bridge supports 64-bit addresses and the Prefetchable Base Upper-32 bits and Prefetchable Limit Upper 32-bits registers hold the rest of the 64-bit prefetchable base and limit addresses respectively.

Setting the prefetchable memory limit less than prefetchable memory base disables the 64-bit prefetchable memory range altogether.

Note: In general, the memory base and limit registers won't be programmed by software without clearing the MSE bit first.

3.3.3.24 PMLIMIT—Prefetchable Memory Limit

Register: PMLIMIT Device: 3,5 (PCIe) Function: 0 Offset: 26h			
Bit	Attr	Default	Description
15:4	RW	000h	Prefetchable Memory Limit Address This field corresponds to A[31:20] of the memory address on the PCI Express bridge.
3:0	RO	1h	Prefetchable Memory Limit Address Capability Integrated I/O sets this field to 01h to indicate 64-bit capability.

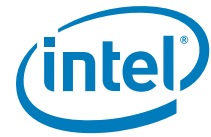

3.3.3.25 PMBASEU—Prefetchable Memory Base (Upper 32 bits)

The Prefetchable Base Upper 32-bits and Prefetchable Limit Upper 32-bits registers are extensions to the Prefetchable Memory Base and Prefetchable Memory Limit registers to support a 64-bit prefetchable memory address range.

Register: PMBASEU Device: 3,5 (PCIe) Function: 0 Offset: 28h			
Bit	Attr	Default	Description
31:0	RW	00000000h	Prefetchable Upper 32-bit Memory Base Address This field corresponds to A[63:32] of the memory address that maps to the upper base of the prefetchable range of memory accesses that will be passed by the PCI Express bridge. The OS should program these bits based on the available physical limits of the system.

3.3.3.26 PMLIMITU—Prefetchable Memory Limit (Upper 32 bits)

Register: PMLIMITU Device: 3,5 (PCIe) Function: 0 Offset: 2Ch			
Bit	Attr	Default	Description
31:0	RW	00000000h	Prefetchable Upper 32-bit Memory Limit Address This field corresponds to A[63:32] of the memory address that maps to the upper limit of the prefetchable range of memory accesses that will be passed by the PCI Express bridge. OS should program these bits based on the available physical limits of the system.

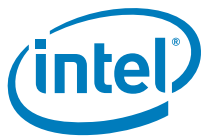

3.3.3.27 BCTRL—Bridge Control Register

The Bridge Control register provides additional control for the secondary interface (that is, PCI Express) as well as some bits that affect the overall behavior of the “virtual” PCI-to-PCI bridge embedded within the Integrated I/O, for example, VGA-compatible address range mapping.

(Sheet 1 of 2)

Register: BCTRL Device: 3,5 (PCIe) Function: 0 Offset: 3Eh			
Bit	Attr	Default	Description
15:12	RO	0h	<i>Reserved</i>
11	RO	0	Discard Timer SERR Status Not applicable to PCI Express*. This bit is hardwired to 0.
10	RO	0	Discard Timer Status Not applicable to PCI Express. This bit is hardwired to 0.
9	RO	0	Secondary Discard Timer Not applicable to PCI Express. This bit is hardwired to 0.
8	RO	0	Primary Discard Timer Not applicable to PCI Express. This bit is hardwired to 0.
7	RO	0	Fast Back-to-Back Enable Not applicable to PCI Express. This bit is hardwired to 0.
6	RW	0	Secondary Bus Reset 0 = No reset happens on the PCI Express port. 1 = Setting this bit triggers a hot reset on the link for the corresponding PCI Express port and the PCI Express hierarchy domain subordinate to the port. This sends the LTSSM into the Training (or Link) Control Reset state, which necessarily implies a reset to the downstream device and all subordinate devices. The transaction layer corresponding to port will be emptied by Integrated I/O when this bit is set. This means that in the outbound direction, all posted transactions are dropped and non-posted transactions are sent a UR response. In the inbound direction, completions for inbound NP requests are dropped when they arrive. Inbound posted writes are required to be flushed as well either by dropping the packets are by retiring them normally. Note also that a secondary bus reset will not reset the virtual PCI-to-PCI bridge configuration registers of the targeted PCI Express port.
5	RO	0	Master Abort Mode Not applicable to PCI Express. This bit is hardwired to 0.
4	RW	0	VGA 16-bit Decode This bit enables the virtual PCI-to-PCI bridge to provide 16-bit decoding of VGA I/O address precluding the decoding of alias addresses every 1 KB. 0 = Execute 10-bit address decodes on VGA I/O accesses. 1 = Execute 16-bit address decodes on VGA I/O accesses. This bit only has meaning if bit 3 of this register is also set to 1, enabling VGA I/O decoding and forwarding by the bridge. Refer to the <i>PCI-to-PCI Bridge Specification</i> for further details of this bit behavior.
3	RW	0	VGA Enable This bit controls the routing of processor initiated transactions targeting VGA compatible I/O and memory address ranges. This bit must only be set for one PCI Express port.

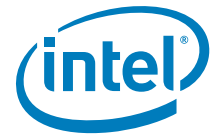

(Sheet 2 of 2)

Register: BCTRL Device: 3,5 (PCIe) Function: 0 Offset: 3Eh			
Bit	Attr	Default	Description
2	RW	0	ISA Enable This bit modifies the response by the Integrated I/O to an I/O access issued by the processor that target ISA I/O addresses. This applies only to I/O addresses that are enabled by the IOBASE and IOLIM registers. 0 = All addresses defined by the IOBASE and IOLIM for processor I/O transactions will be mapped to PCI Express. 1 = The Integrated I/O will <i>not</i> forward to PCI Express any I/O transactions addressing the last 768 bytes in each 1-KB block even if the addresses are within the range defined by the IOBASE and IOLIM registers.
1	RW	0	SERR Enable This bit controls forwarding of ERR_COR, ERR_NONFATAL and ERR_FATAL messages from the PCI Express* port to the primary side. 0 = Disables forwarding of ERR_COR, ERR_NONFATAL and ERR_FATAL. 1 = Enables forwarding of ERR_COR, ERR_NONFATAL and ERR_FATAL messages.
0	RW	0	Parity Error Response Enable The Integrated I/O ignores this bit. This bit though affects the setting of Bit 8 in the SECSTS register.

3.3.4 Device-Specific PCI Configuration Space — 40h to FFh

3.3.4.1 SCAPID—Subsystem Capability Identity

Register: SCAPID Device: 3,5 (PCIe) Function: 0 Offset: 40h			
Bit	Attr	Default	Description
7:0	RO	0Dh	Capability ID Assigned by PCI-SIG for subsystem capability ID.

3.3.4.2 SNXTPTR—Subsystem ID Next Pointer

Register: SNXTPTR Device: 3,5 (PCIe) Function: 0 Offset: 41h			
Bit	Attr	Default	Description
7:0	RWO	60h	Next Ptr This field is set to 80h for the next capability list (MSI capability structure) in the chain.



3.3.4.3 SVID—Subsystem Vendor ID

Register: SVID Device: 3,5 (PCIe) Function: 0 Offset: 44h			
Bit	Attr	Default	Description
15:0	RWO	8086h	Subsystem Vendor Identification This field is programmed during boot-up to indicate the vendor of the system board. After it has been written once, it becomes read only.

3.3.4.4 SID—Subsystem Identity

Register: SID Device: 3,5 (PCIe) Function: 0 Offset: 46h			
Bit	Attr	Default	Description
15:0	RWO	00h	Subsystem Identification Number Assigned by the subsystem vendor to uniquely identify the subsystem.

3.3.4.5 DMIRCBAR—DMI Root Complex Register Block Base Address Register

This is the base address for the root complex configuration space. This window of addresses contains the Root complex Register set for the PCI Express hierarchy associated with the processor. On Reset, the Root complex configuration space is disabled and must be enabled by writing a 1 to DMIRCBAREN [Device 0, offset 50h, bit 0]. All the bits in this register are locked in Intel TXT enabled mode.

Register: DMIRCBAR Device: 0 (DMI) Function: 0 Offset: 50h			
Bit	Attr	Default	Description
31:12	RWO	00000h	DMI Base Address (DMIRCBAR) This field corresponds to Bits 32:12 of the base address DMI Root Complex register space. BIOS will program this register resulting in a base address for a 4-KB block of contiguous memory address space. This register ensures that a naturally aligned 4-KB space is allocated within the first 64 GB of addressable memory space. System Software uses this base address to program the DMI Root Complex register set. All the Bits in this register are locked in Intel Trusted Execution Technology (Intel TXT) enabled mode.
11:1	RV	00h	<i>Reserved</i>
0	RW	0	DMIRCBAR Enable (DMIRCBAREN) 0 = DMIRCBAR is disabled and does not claim any memory. 1 = DMIRCBAR memory mapped accesses are claimed and decoded.

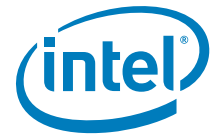

3.3.4.6 MSICAPID—MSI Capability ID

Register: MSICAPID Device: 0 (DMI), 3,5 (PCIe) Function: 0 Offset: 60h			
Bit	Attr	Default	Description
7:0	RO	05h	Capability Identifier Assigned by PCI-SIG for MSI (root ports).

3.3.4.7 MSINXTPTR—MSI Next Pointer

Register: MSINXTPTR Device: 0 (DMI), 3,5 (PCIe) Function: 0 Offset: 61h			
Bit	Attr	Default	Description
7:0	RWO	90h	Next Ptr This field is set to 90h for the next capability list (PCI Express capability structure) in the chain.

3.3.4.8 MSICTRL—MSI Control Register

Register: MSICTRL Device: 0 (DMI), 3,5 (PCIe) Function: 0 Offset: 62h			
Bit	Attr	Default	Description
15:9	RV	00h	<i>Reserved</i>
8	RO	1	<i>Reserved</i>
7	RO	0	64-bit Address Capable This field is hardwired to 0h since the message addresses are only 32-bit addresses (for example, FEEx_xxxxh).
6:4	RW	000	Multiple Message Enable Applicable only to PCI Express* ports. Software writes to this field to indicate the number of allocated messages which is aligned to a power of two. When MSI is enabled, the software will allocate at least one message to the device. A value of 000 indicates 1 message. Any value greater than or equal to 001 indicates a message of 2.
3:1	RO	001	Multiple Message Capable Integrated I/O Express ports support two messages for all their internal events.
0	RW	0	MSI Enable The software sets this bit to select platform-specific interrupts or transmit MSI messages. 0 = Disables MSI from being generated. 1 = MSI will be generated when appropriate conditions occur.



3.3.4.9 MSIAR—MSI Address Register

The MSI Address Register (MSIAR) contains the system specific address information to route MSI interrupts from the root ports and is broken into its constituent fields.

Register: MSIAR Device: 0 (DMI), 3,5 (PCIe) Function: 0 Offset: 64h			
Bit	Attr	Default	Description
31:20	RW	0h	Address MSB This field specifies the 12 most significant bits of the 32-bit MSI address. This field is R/W for compatibility reasons only.
19:12	RW	00h	Address Destination ID This field is initialized by software for routing the interrupts to the appropriate destination.
11:4	RW	00h	Address Extended Destination ID This field is not used by IA32 processor and is used in IPF as an address extension.
3	RW	0h	Address Redirection Hint 0 = directed 1 = redirectable
2	RW	0h	Address Destination Mode 0 = physical 1 = logical
1:0	RO	0h	<i>Reserved</i>

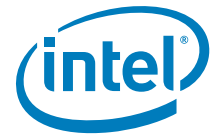

3.3.4.10 MSIDR—MSI Data Register

The MSI Data Register contains all the data (interrupt vector) related to MSI interrupts from the root ports.

Register: MSIDR Device: 0 (DMI), 3,5 (PCIe) Function: 0 Offset: 68h			
Bit	Attr	Default	Description
31:16	RO	0000h	Reserved
15:14	RW	0h	Reserved
13:12	RW	0h	Reserved
11:8	RW	0h	Delivery Mode 0000 = Fixed: Trigger Mode can be edge or level. 0001 = Lowest Priority: Trigger Mode can be edge or level. 0010 = Intel SMI/PMI/MCA - Not supported using MSI of root port 0011 = Reserved - Not supported using MSI of root port 0100 = NMI - Not supported using MSI of root port 0101 = INIT - Not supported using MSI of root port 0110 = Reserved 0111 = ExtINT - Not supported using MSI of root port 1000–1111 - Reserved
7:0	RW	0h	Interrupt Vector The interrupt vector (LSB) will be modified by the Integrated I/O to provide context sensitive interrupt information for different events that require attention from the processor, for example, Power Management and error events.

3.3.4.11 MSIMSK—MSI Mask Bit Register

The Mask Bit register enables software to disable message sending on a per-vector basis.

Register: MSIMSK Device: 0 (DMI), 3,5 (PCIe) Function: 0 Offset: 6Ch			
Bit	Attr	Default	Description
31:2	RV	0h	Reserved
1:0	RW	0h	Mask Bit For each Mask bit that is set, the PCI Express* port is prohibited from sending the associated message.



3.3.4.12 MSIPENDING—MSI Pending Bit Register

The Mask Pending register enables software to defer message sending on a per-vector basis.

Register: MSIPENDING Device: 0 (DMI), 3,5 (PCIe) Function: 0 Offset: 70h			
Bit	Attr	Default	Description
31:2	RV	0h	Reserved
1:0	RO	0h	Pending Bit For each Pending bit that is set, the PCI Express port has a pending associated message.

3.3.4.13 PEGCAPID—PCI Express* Capability Identity Register

The PCI Express Capability List register enumerates the PCI Express Capability structure in the PCI 3.0 configuration space.

Register: PEGCAPID Device: 0 (DMI), 3,5 (PCIe) Function: 0 Offset: 90h			
Bit	Attr	Default	Description
7:0	RO	10h	Capability ID Provides the PCI Express capability ID assigned by PCI-SIG.

3.3.4.14 PEGNXPTR—PCI Express* Next Pointer Register

The PCI Express Capability List register enumerates the PCI Express Capability structure in the PCI 3.0 configuration space.

Register: PEGNXPTR Device: 0 (DMI), 3,5 (PCIe) Function: 0 Offset: 91h			
Bit	Attr	Default	Description
7:0	RWO	E0h	Next Ptr This field is set to the PCI PM capability.

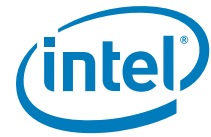

3.3.4.15 PEGCAP—PCI Express* Capabilities Register

The PCI Express Capabilities register identifies the PCI Express device type and associated capabilities.

Register: PEGCAP Device: 0 (DMI), 3,5 (PCIe) Function: 0 Offset: 92h			
Bit	Attr	Default	Description
15:14	RV	0h	<i>Reserved</i>
13:9	RO	00h	Interrupt Message Number Applies only to the root ports. This field indicates the interrupt message number that is generated for PM/HP events. When there are more than one MSI interrupt Number, this register field is required to contain the offset between the base Message Data and the MSI Message that is generated when the status bits in the slot status register or root port status registers are set. IIO assigns the first vector for PM/HP events and so this field is set to 0.
8	RWO	0	Slot Implemented Applies only to the root ports. 0 = Indicates no slot is connected to this port. 1 = Indicates that the PCI Express link associated with the port is connected to a slot. This register bit is of type "write once" and is controlled by BIOS/special initialization firmware.
7:4	RO	0100	Device/Port Type This field identifies the type of device. It is set to 0100 for all the Express ports.
3:0	RWO	Dev 3,5: 2h Dev 3,5: 2h Dev 0: 1h	Capability Version This field identifies the version of the PCI Express capability structure. Set to 2h for PCI Express devices for compliance with the extended base registers. Note: BIOS should set this to 1h for Device 0 (DMI).



3.3.4.16 DEVCAP—PCI Express* Device Capabilities Register

The PCI Express Device Capabilities register identifies device specific information for the device.

Register: DEVCAP Device: 0 (DMI), 3,5 (PCIe) Function: 0 Offset: 94h			
Bit	Attr	Default	Description
31:28	RV	0h	<i>Reserved</i>
27:26	RO	0h	Captured Slot Power Limit Scale Does not apply to root ports or integrated devices.
25:18	RO	00h	Captured Slot Power Limit Value Does not apply to root ports or integrated devices.
17:16	RV	0h	<i>Reserved</i>
15	RO	1	Role Based Error Reporting Integrated I/O is <i>PCI Express Base Specification</i> compliant and supports this feature.
14	RO	0	Power Indicator Present on Device Does not apply to root ports or integrated devices.
13	RO	0	Attention Indicator Present Does not apply to root ports or integrated devices.
12	RO	0	Attention Button Present Does not apply to root ports or integrated devices.
11:9	RO	000	<i>Reserved</i>
8:6	RO	000	<i>Reserved</i>
5	RO	1	Extended Tag Field Supported Integrated I/O devices support 8-bit tag.
4:3	RO	0h	<i>Reserved</i>
2:0	RO	Dev 0: 000b Dev 3,5: 001b Dev 3,5: 001b	Max Payload Size Supported IIO supports 256B payloads on PCI Express ports and 128B on the DMI port (Device 0).

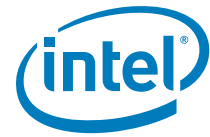

3.3.4.17 DEVCTRL—PCI Express* Device Control Register

The PCI Express Device Control register controls PCI Express specific capabilities parameters associated with the device.

(Sheet 1 of 2)

Register: DEVCTRL Device: 0 (DMI), 3,5 (PCIe) Function: 0 Offset: 98h			
Bit	Attr	Default	Description
15	RV	0h	<i>Reserved</i>
14:12	RO	000	Max_Read_Request_Size Express/DMI ports in Integrated I/O do not generate requests greater than 128B and this field is ignored.
11	RO	0	Enable No Snoop Not applicable to root ports since they never set the 'No Snoop' bit for transactions they originate (not forwarded from peer) to PCI Express. This bit has no impact on forwarding of NoSnoop attribute on peer requests.
10	RO	0	<i>Reserved</i>
9	RO	0	<i>Reserved</i>
8	RW	0h	Extended Tag Field Enable This bit enables the PCI Express/DMI ports to use an 8-bit Tag field as a requester.
7:5	RW	000	Max Payload Size This field is set by configuration software for the maximum TLP payload size for the PCI Express port. As a receiver, the IIO must handle TLPs as large as the set value. As a requester (that is, for requests where Integrated IO's own RequesterID is used), it must not generate TLPs exceeding the set value. Permissible values that can be programmed are indicated by the Max_Payload_Size_Supported in the Device Capabilities register: 000 = 128B max payload size 001 = 256B max payload size (applies only to standard PCI Express ports and DMI port aliases to 128B) others = alias to 128B
4	RO	0	Enable Relaxed Ordering Not applicable to root ports since they never set relaxed ordering bit as a requester (this does not include Tx forwarded from peer devices). This bit has no impact on forwarding of relaxed ordering attribute on peer requests.
3	RW	0	Unsupported Request Reporting Enable Applies only to the PCI Express/DMI ports. This bit controls the reporting of unsupported requests that Integrated I/O itself detects on requests its receives from a PCI Express/DMI port. 0 = Reporting of unsupported requests is disabled. 1 = Reporting of unsupported requests is enabled. Refer to the latest <i>PCI Express Base Specification</i> for complete details of how this bit is used in conjunction with other bits to UR errors.
2	RW	0	Fatal Error Reporting Enable Applies only to the PCI Express/DMI ports. Controls the reporting of fatal errors that Integrated I/O detects on the PCI Express/DMI interface. 0 = Reporting of Fatal error detected by device is disabled. 1 = Reporting of Fatal error detected by device is enabled. Refer to the latest <i>PCI Express Base Specification</i> for complete details of how this bit is used in conjunction with other bits to report errors. For the PCI Express/DMI ports, this bit is not used to control the reporting of other internal component uncorrectable fatal errors (at the port unit) in any way.



(Sheet 2 of 2)

Register: DEVCTRL Device: 0 (DMI), 3,5 (PCIe) Function: 0 Offset: 98h			
Bit	Attr	Default	Description
1	RW	0	Non Fatal Error Reporting Enable Applies only to the PCI Express/DMI ports. Controls the reporting of non-fatal errors that Integrated I/O detects on the PCI Express/DMI interface. 0 = Reporting of Non Fatal error detected by device is disabled. 1 = Reporting of Non Fatal error detected by device is enabled. Refer to the latest <i>PCI Express Base Specification</i> for complete details of how this bit is used in conjunction with other bits to report errors. For the PCI Express/DMI ports, this bit is not used to control the reporting of other internal component uncorrectable non-fatal errors (at the port unit) in any way.
0	RW	0	Correctable Error Reporting Enable Applies only to the PCI Express/DMI ports. Controls the reporting of correctable errors that Integrated I/O detects on the PCI Express/DMI interface. 0 = Reporting of link Correctable error detected by the port is disabled. 1 = Reporting of link Correctable error detected by port is enabled. Refer to the latest <i>PCI Express Base Specification</i> for complete details of how this bit is used in conjunction with other bits to report errors. For the PCI Express/DMI ports, this bit is not used to control the reporting of other internal component correctable errors (at the port unit) in any way.

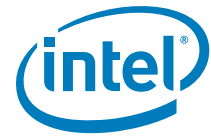

3.3.4.18 DEVSTS—PCI Express* Device Status Register

The PCI Express Device Status register provides information about PCI Express device specific parameters associated with the device.

Register: DEVSTS Device: 0 (DMI), 3,5 (PCIe) Function: 0 Offset: 9Ah			
Bit	Attr	Default	Description
15:6	RV	000h	<i>Reserved</i>
5	RO	0h	Transactions Pending Does not apply to root/DMI ports, that is, bit hardwired to 0 for these devices.
4	RO	0	<i>Reserved</i>
3	RW1C	0	Unsupported Request Detected This bit applies only to the root/DMI ports. This bit indicates that the root port detected an Unsupported Request. Errors are logged in this register regardless of whether error reporting is enabled or not in the Device Control Register. 0 = No unsupported request detected by the root port. 1 = Unsupported Request detected at the device/port. These unsupported requests are NP requests inbound that the root port received and it detected them as unsupported requests (for example, address decoding failures that the root port detected on a packet, receiving inbound lock reads, BME bit is clear, and so forth). Note that this bit is not set on peer-to-peer completions with UR status that are forwarded by the root port to the PCI Express link.
2	RW1C	0	Fatal Error Detected This bit indicates that a fatal (uncorrectable) error is detected by the device. Errors are logged in this register regardless of whether error reporting is enabled or not in the Device Control register. 0 = No Fatal errors detected. 1 = Fatal errors detected.
1	RW1C	0	Non Fatal Error Detected This bit gets set if a non-fatal uncorrectable error is detected by the device. Errors are logged in this register regardless of whether error reporting is enabled or not in the Device Control register. 0 = No Fatal errors detected. 1 = Fatal errors detected.
0	RW1C	0	Correctable Error Detected This bit gets set if a correctable error is detected by the device. Errors are logged in this register regardless of whether error reporting is enabled or not in the PCI Express Device Control register. 0 = No Fatal errors detected. 1 = Fatal errors detected.

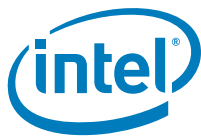

3.3.4.19 LNKCAP—PCI Express* Link Capabilities Register

The Link Capabilities register identifies the PCI Express specific link capabilities.

(Sheet 1 of 2)

Register: LNKCAP Device: 0 (DMI), 3,5 (PCIe) Function: 0 Offset: 9Ch			
Bit	Attr	Default	Description
31:24	RWO	0	Port Number This field indicates the PCI Express port number for the link and is initialized by software/BIOS.
23:22	RV	0h	<i>Reserved</i>
21	RO	1	Link Bandwidth Notification Capability A value of 1b indicates support for the Link Bandwidth Notification status and interrupt mechanisms.
20	RO	1	Data Link Layer Link Active Reporting Capable IIO supports reporting status of the data link layer so software knows when it can enumerate a device on the link or otherwise know the status of the link.
19	RO	1	Surprise Down Error Reporting Capable IIO supports reporting a surprise down error condition
18	RO	0	Clock Power Management Does not apply to IIO.
17:15	RWO	010	L1 Exit Latency This field indicates the L1 exit latency for the given PCI Express port. It indicates the length of time this port requires to complete transition from L1 to L0. 000 = Less than 1 μ s 001 = 1 is to less than 2 μ s 010 = 2 is to less than 4 μ s 011 = 4 is to less than 8 μ s 100 = 8 is to less than 16 μ s 101 = 16 is to less than 32 μ s 110 = 32 is to 64 μ s 111 = More than 64 μ s
14:12	RWO	011	L0s Exit Latency This field indicates the L0s exit latency (that is, L0s to L0) for the PCI Express port. 000 = Less than 64 ns 001 = 64 ns to less than 128 ns 010 = 128 ns to less than 256 ns 011 = 256 ns to less than 512 ns 100 = 512 ns to less than 1 μ s 101 = 1 is to less than 2 ns 110 = 2 is to 4 ns 111 = More than 4 ns
11:10	RWO	11	Active State Link PM Support This field indicates the level of active state power management supported on the given PCI Express port. 00 = Disabled 01 = L0s Entry Supported 10 = Reserved 11 = L0s and L1 Supported

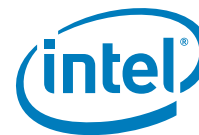

(Sheet 2 of 2)

Register: LNKCAP Device: 0 (DMI), 3,5 (PCIe) Function: 0 Offset: 9Ch			
Bit	Attr	Default	Description
9:4	RWO	010000b	Maximum Link Width This field indicates the maximum width of the given PCI Express Link attached to the port. 001000 = x8 010000 = x16 000100 = Reserved Others = Reserved This is left as a RWO register for BIOS to update based on the platform usage of the links.
3:0	RWO	Dev 3,5: See description Dev 3,5: See description Dev 0: 0001b	Maximum Link Speeds Supported Integrated I/O supports both 2.5 Gbps and 5 Gbps speeds 0001b = 2.5 GT/s support only 0010b = 2.5 GT/s and 5.0GT/s support

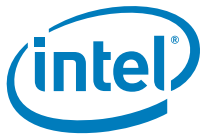

3.3.4.20 LNKCON—PCI Express* Link Control Register (Device 0)

The PCI Express Link Control register controls the PCI Express Link specific parameters.

Register: LNKCON Device: 0 (DMI) Function: 0 Offset: A0h			
Bit	Attr	Default	Description
15:12	RV	0	<i>Reserved</i>
11	RO	0	Link Autonomous Bandwidth Interrupt Enable When set to 1, this bit enables the generation of an interrupt to indicate that the Link Autonomous Bandwidth Status bit has been set.
10	RO	0	Link Bandwidth Management Interrupt Enable When set to 1, this bit enables the generation of an interrupt to indicate that the Link Bandwidth Management Status bit has been set.
9	RO	0	Hardware Autonomous Width Disable When set, this bit disables hardware from changing the link width for reasons other than attempting to correct unreliable link operation
8	RO	0	Enable Clock Power Management N/A to Integrated I/O
7	RO	0	Extended Sync When set to 1, this bit forces the transmission of additional ordered sets when exiting L0s and when in recovery. See the latest <i>PCI Express Base Specification</i> for details.
6	RO	0	Common Clock Configuration Integrated I/O does nothing with this bit
5	RO	0	Retrain Link A write of 1 to this bit initiates link retraining in the given PCI Express port by directing the LTSSM to the recovery state if the current state is [L0, L0s or L1]. If the current state is anything other than L0, L0s, L1 then a write to this bit does nothing. This bit always returns 0 when read. If the Target Link Speed field has been set to a non-zero value different than the current operating speed, then the LTSSM will attempt to negotiate to the target link speed. It is permitted to write 1b to this bit while simultaneously writing modified values to other fields in this register. When this is done, all modified values that affect link retraining must be applied in the subsequent retraining.
4	RO	0	Link Disable This field controls whether the link associated with the PCI Express port is enabled or disabled. When this bit is a 1, a previously configured link (a link that has gone past the polling state) would return to the “disabled” state as defined in the <i>PCI Express Base Specification</i> . When this bit is clear, an LTSSM in the “disabled” state goes back to the detect state. 0 = Enables the link associated with the PCI Express port. 1 = Disables the link associated with the PCI Express port.
3	RO	0	Read Completion Boundary Set to zero to indicate Integrated I/O could return read completions at 64B boundaries.
2	RV	0	<i>Reserved</i>
1:0	RO	00	Active State Link PM Control When 01b or 11b, L0s on transmitter is enabled, otherwise it is disabled.

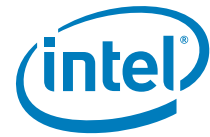

3.3.4.21 LNKCON—PCI Express* Link Control Register

The PCI Express Link Control register controls the PCI Express Link specific parameters.

Register: LNKCON Device: 3, 5 (PCIe) Function: 0 Offset: A0h			
Bit	Attr	Default	Description
15:12	RV	0	<i>Reserved</i>
11	RW	0	Link Autonomous Bandwidth Interrupt Enable When set to 1, this bit enables the generation of an interrupt to indicate that the Link Autonomous Bandwidth Status bit has been set.
10	RW	0	Link Bandwidth Management Interrupt Enable When set to 1, this bit enables the generation of an interrupt to indicate that the Link Bandwidth Management Status bit has been set.
9	RW	0	Hardware Autonomous Width Disable When set to 1, this bit disables hardware from changing the Link width for reasons other than attempting to correct unreliable Link operation by reducing Link width.
8	RO	0	Enable Clock Power Management N/A to IIO
7	RW	0	Extended Sync When set to 1, this bit forces the transmission of additional ordered sets when exiting L0s and when in recovery. Refer to the latest <i>PCI Express Base Specification</i> for details.
6	RW	0	Common Clock Configuration Integrated I/O does nothing with this bit.
5	WO	0	Retrain Link A write of 1 to this bit initiates link retraining in the given PCI Express port by directing the LTSSM to the recovery state if the current state is [L0, L0s, or L1]. If the current state is anything other than L0, L0s, L1, then a write to this bit does nothing. This bit always returns 0 when read. If the Target Link Speed field has been set to a non-zero value different than the current operating speed, the LTSSM will attempt to negotiate to the target link speed. It is permitted to write 1 to this bit while simultaneously writing modified values to other fields in this register. When this is done, all modified values that affect link retraining must be applied in the subsequent retraining.
4	RW	0	Link Disable This field controls whether the link associated with the PCI Express port is enabled or disabled. When this bit is a 1, a previously configured link (a link that has gone past the polling state) would return to the "disabled" state as defined in the latest <i>PCI Express Base Specification</i> When this bit is clear, an LTSSM in the "disabled" state goes back to the detect state. 0 = Enables the link associated with the PCI Express port. 1 = Disables the link associated with the PCI Express port.
3	RO	0	Read Completion Boundary Set to zero to indicate IIO could return read completions at 64B boundaries.
2	RV	0	<i>Reserved</i>
1:0	RW	00	Active State Link PM Control When 01b or 11b, L0s on transmitter is enabled; otherwise, it is disabled.

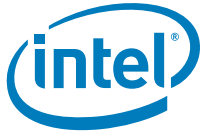

3.3.4.22 LNKSTS—PCI Express* Link Status Register

The PCI Express Link Status register provides information on the status of the PCI Express Link such as negotiated width, training, and so forth.

(Sheet 1 of 2)

Register: LNKSTS Device: 0 (DMI), 3, 5 (PCIe) Function: 0 Offset: A2h			
Bit	Attr	Default	Description
15	RW1C	0	Link Autonomous Bandwidth Status This bit is set to 1 by hardware to indicate that hardware has autonomously changed link speed or width, without the port transitioning through DL_Down status, for reasons other than to attempt to correct unreliable link operation. Integrated I/O sets this bit when it receives eight consecutive TS1 or TS2 ordered sets with the Autonomous Change bit set. Note that if the status bit is set by hardware in the same clock software clears the status bit, the status bit should remain set and if MSI is enabled, the hardware should trigger a new MSI.
14	RW1C	0	Link Bandwidth Management Status This bit is set to 1 by hardware to indicate that either of the following has occurred without the port transitioning through DL_Down status: a) A link retraining initiated by a write of 1b to the Retrain Link bit has completed b) Hardware has autonomously changed link speed or width to attempt to correct unreliable link operation Note that if the status bit is set by hardware in the same clock software clears the status bit, the status bit should remain set and if MSI is enabled, the hardware should trigger a new MSI.
13	RO	0	Data Link Layer Link Active This bit is set to 1 when the Data Link Control and Management State Machine is in the DL_Active state, 0b otherwise. On a downstream port or upstream port, when this bit is 0b, the transaction layer associated with the link will abort all transactions that would otherwise be routed to that link.
12	RWO	1	Slot Clock Configuration This bit indicates whether Integrated I/O receives clock from the same XTAL that also provides clock to the device on the other end of the link. 0 = Indicates that the device uses an independent clock irrespective of the presence of a reference on the connector. 1 = Indicates the same physical reference clock to devices on both ends of the link.
11	RO	0	Link Training This field indicates the status of an ongoing link training session in the PCI Express port 0 = LTSSM has exited the recovery/configuration state 1 = LTSSM is in recovery/configuration state or the Retrain Link was set but training has not yet begun. The Integrated I/O hardware clears this bit once LTSSM has exited the recovery/configuration state. Refer to the latest <i>PCI Express Base Specification</i> for details of which states within the LTSSM would set this bit and which states would clear this bit.
10	RO	0	<i>Reserved</i>



(Sheet 2 of 2)

Register: LNKSTS Device: 0 (DMI), 3, 5 (PCIe) Function: 0 Offset: A2h			
Bit	Attr	Default	Description
9:4	RO	0h	Negotiated Link Width This field indicates the negotiated width of the given PCI Express link after training is completed. Only x8 and x16 link width negotiations are supported in Integrated I/O. 0x08 = x8 max link width 0x10 = x16 max link width The value in this field is not defined and could show any value when the link is not up. Software determines if the link is up or not by reading Bit 13 of this register.
3:0	RO	1h	Current Link Speed This field indicates the negotiated Link speed of the given PCI Express Link. 0001b = 2.5 Gbps 0010b = 5 Gbps Others = Reserved The value in this field is not defined and could show any value, when the link is not up. Software determines if the link is up or not by reading Bit 13 of this register.



3.3.4.23 SLTCAP—PCI Express* Slot Capabilities Register

The Slot Capabilities register identifies the PCI Express specific slot capabilities. These registers must be ignored by software on the DMI links.

Note: Hot-plug for PCIe is not supported on Desktop, Platforms.

Register: SLTCAP Device: 0 (DMI), 3, 5 (PCIe) Function: 0 Offset: A4h			
Bit	Attr	Default	Description
31:19	RWO	0h	Physical Slot Number This field indicates the physical slot number of the slot connected to the PCI Express* port and is initialized by BIOS.
18	RO	0h	Command Complete Not Capable Integrated I/O is capable of command complete interrupt.
17	RWO	0h	Electromechanical Interlock Present When set to 1, this bit indicates that an Electromechanical Interlock is implemented on the chassis for this slot and that lock is controlled by Bit 11 in Slot Control register. BIOS Note: This capability is not set if the Electromechanical Interlock control is connected to main slot power control.
16:15	RWO	0h	Slot Power Limit Scale This field specifies the scale used for the Slot Power Limit Value and is initialized by BIOS. IIO uses this field when it sends a Set_Slot_Power_Limit message on PCI Express. Range of Values: 00 = 1.0x 01 = 0.1x 10 = 0.01x 11 = 0.001x
14:7	RWO	00h	Slot Power Limit Value This field specifies the upper limit on power supplied by slot in conjunction with the Slot Power Limit Scale value defined previously Power limit (in Watts) = SPLS x SPLV. This field is initialized by BIOS. IIO uses this field when it sends a Set_Slot_Power_Limit message on PCI Express. Design Note: Integrated I/O can choose to send the Set_Slot_Power_Limit message on the link at first link up condition without regards to whether this register and the Slot Power Limit Scale register are programmed yet by BIOS. Integrated I/O must then be designed to discard a received Set_Slot_Power_Limit message without an error.
6:5	RV	0h	<i>Reserved</i> - Hot-Plug is not supported.
4	RWO	0h	Power Indicator Present When set to 1, this bit indicates that a Power Indicator is implemented for this slot and is electrically controlled by the chassis.
3	RWO	0h	Attention Indicator Present When set to 1, this bit indicates that an Attention Indicator is implemented for this slot and is electrically controlled by the chassis
2	RWO	0h	MRL Sensor Present When set to 1, this bit indicates that an MRL Sensor is implemented on the chassis for this slot.
1	RWO	0h	Power Controller Present When set to 1, this bit indicates that a software controllable power controller is implemented on the chassis for this slot.
0	RV	0h	<i>Reserved</i> - Hot-Plug is not supported.

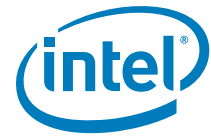

3.3.4.24 SLTCON—PCI Express* Slot Control Register

The Slot Control register identifies the PCI Express specific slot control parameters for operations such as Power Management.

Register: SLTCON Device: 0 (DMI), 3, 5 (PCIe) Function: 0 Offset: A8h			
Bit	Attr	Default	Description
15:13	RV	0h	<i>Reserved</i>
12	RWS	0	Data Link Layer State Changed Enable When set to 1, this field enables software notification when Data Link Layer Link Active field is changed
11	RW	0	Electromechanical Interlock Control If an electromechanical lock is implemented, a write of 1b to this field causes the state of the interlock to toggle. Write of 0b has no effect. This bit always returns a 0 when read. If electromechanical lock is not implemented, then either a write of 1 or 0 to this register has no effect.
10	RWS	1	Power Controller Control If a power controller is implemented, when written, this bit sets the power state of the slot per the defined encodings. Reads of this field must reflect the value from the latest write. 0 = Power On 1 = Power Off
9:8	RW	3h	Power Indicator Control If a Power Indicator is implemented, writes to this register set the Power Indicator to the written state. Reads of this field must reflect the value from the latest write. 00 = Reserved 01 = On 10 = Blink (Integrated I/O drives 1.5-Hz square wave for Chassis mounted LEDs) 11 = Off When this register is written, the event is signaled using the virtual pins of the Integrated I/O over a dedicated SMBus port. Integrated I/O does not generate the Power_Indicator_On/Off/Blink messages on PCI Express when this field is written to by software.
7:6	RW	3h	Attention Indicator Control If an Attention Indicator is implemented, writes to this register set the Attention Indicator to the written state. Reads of this field reflect the value from the latest write. 00 = Reserved 01 = On 10 = Blink (The Integrated I/O drives 1.5 Hz square wave) 11 = Off When this register is written, the event is signaled using the virtual pins of the Integrated I/O over a dedicated SMBus port. Integrated I/O does not generated the Attention_Indicator_On/Off/Blink messages on PCI Express* when this field is written to by software.
5:0	RV	00h	<i>Reserved</i>

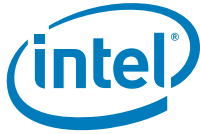

3.3.4.25 ROOTCON—PCI Express* Root Control Register

The PCI Express Root Control register specifies parameters specific to the root complex port.

(Sheet 1 of 2)

Register: ROOTCON Device: 0 (DMI), 3, 5 (PCIe) Function: 0 Offset: ACh			
Bit	Attr	Default	Description
15:5	RV	0h	<i>Reserved</i>
4	RW	0h	CRS Software Visibility Enable When set to 1, this bit enables the Root Port to return Configuration Request Retry Status (CRS) Completion Status to software. If 0, retry status cannot be returned to software. Root ports that do not implement this capability must hardwire this bit to 0b.
3	RW	0h	PME Interrupt Enable This field controls the generation of MSI interrupts and Intx messages for PME messages. 0 = Disables interrupt generation for PME messages. 1 = Enables interrupt generation upon receipt of a PME message as reflected in the PME status bit of the Root Status Register.
2	RW	0h	System Error on Fatal Error Enable This field enables notifying the internal core error logic of occurrence of an uncorrectable fatal error at the port or below its hierarchy. The internal core error logic of Integrated I/O then decides if/how to escalate the error further (pins/message, an so forth). 0 = No internal core error logic notification should be generated on a fatal error reported by any of the devices in the hierarchy associated with and including this port. 1 = Indicates that a internal core error logic notification should be generated if a fatal error is reported by any of the devices in the hierarchy associated with and including this port. Note that generation of system notification on a PCI Express/DMI fatal error is orthogonal to generation of an MSI interrupt for the same error. Both a system error and MSI can be generated on a fatal error or software can choose one of the two. Refer to the latest <i>PCI Express Base Specification</i> for details of how this bit is used in conjunction with other error control bits to generate core logic notification of error events in a PCI Express/DMI port.
1	RW	0h	System Error on Non-Fatal Error Enable This field enables notifying the internal core error logic of occurrence of an uncorrectable non-fatal error at the port or below its hierarchy. The internal core error logic of Integrated I/O then decides if/how to escalate the error further (pins/message and so forth). 0 = No internal core error logic notification should be generated on a non-fatal error reported by any of the devices in the hierarchy associated with and including this port 1 = Indicates that a internal core error logic notification should be generated if a non-fatal error is reported by any of the devices in the hierarchy associated with and including this port. Note that generation of system notification on a PCI Express/DMI non-fatal error is orthogonal to generation of an MSI interrupt for the same error. Both a system error and MSI can be generated on a non-fatal error or software can choose one of the two. Refer to the latest <i>PCI Express Base Specification</i> for details of how this bit is used in conjunction with other error control bits to generate core logic notification of error events in a PCI Express/DMI port.

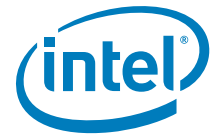

(Sheet 2 of 2)

Register: ROOTCON Device: 0 (DMI), 3, 5 (PCIe) Function: 0 Offset: ACh			
Bit	Attr	Default	Description
0	RW	0h	System Error on Correctable Error Enable This field controls notifying the internal core error logic of the occurrence of a correctable error in the device or below its hierarchy. The internal core error logic of Integrated I/O then decides if/how to escalate the error further (pins/message, and so forth). 0 = No internal core error logic notification should be generated on a correctable error reported by any of the devices in the hierarchy associated with and including this port. 1 = Indicates that an internal core error logic notification should be generated if a correctable error is reported by any of the devices in the hierarchy associated with and including this port. Note that generation of system notification on a PCI Express correctable error is orthogonal to generation of an MSI interrupt for the same error. Both a system error and MSI can be generated on a correctable error or software can choose one of the two. Refer to the latest <i>PCI Express Base Specification</i> for details of how this bit is used in conjunction with other error control bits to generate core logic notification of error events in a PCI Express/DMI port.

3.3.4.26 ROOTCAP—PCI Express* Root Capabilities Register

The PCI Express Root Status register specifies parameters specific to the root complex port.

Register: ROOTCAP Device: 0 (DMI), 3, 5 (PCIe) Function: 0 Offset: AEh			
Bit	Attr	Default	Description
15:1	RV	0h	<i>Reserved</i>
0	RO	1	CRS Software Visibility When set to 1, this bit indicates that the Root Port is capable of returning Configuration Request Retry Status (CRS) Completion Status to software. Integrated I/O supports this capability.

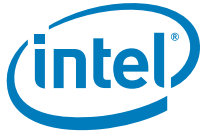

3.3.4.27 ROOTSTS—PCI Express* Root Status Register

The PCI Express Root Status register specifies parameters specific to the root complex port.

Register: ROOTSTS Device: 0 (DMI), 3, 5 (PCIe) Function: 0 Offset: B0h			
Bit	Attr	Default	Description
31:18	RV	0h	<i>Reserved</i>
17	RO	0h	PME Pending This field indicates that another PME is pending when the PME Status bit is set. When the PME Status bit is cleared by software; the pending PME is delivered by hardware by setting the PME Status bit again and updating the Requestor ID appropriately. The PME pending bit is cleared by hardware if no more PMEs are pending.
16	RW1C	0h	PME Status This field indicates a PM_PME message (either from the link or internally from within that root port) was received at the port. 1 = PME was asserted by a requester as indicated by the PMEREQID field This bit is cleared by software by writing a 1.
15:0	RO	0000h	PME Requester ID This field indicates the PCI requester ID of the last PME requestor. If the root port itself was the source of the (virtual) PME message, then a RequesterID of IIOBUSNO:DevNo:0 is logged in this field.

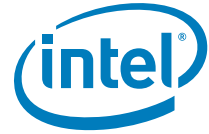

3.3.4.28 DEVCAP2—PCI Express* Device Capabilities Register 2

Register: DEVCAP2 Device: 0 (DMI), 3, 5 (PCIe) Function: 0 Offset: B4h			
Bit	Attr	Default	Description
31:6	RO	0h	Reserved
5	RO	1	Alternative RID Interpretation (ARI) Capable This bit is set to 1b indicating Root Port supports this capability.
4	RO	1	Completion Time-out Disable Supported IIO supports disabling completion time-out.
3:0	RO	1110b	Completion Time-out Values Supported This field indicates device support for the optional Completion Time-out programmability mechanism. This mechanism allows system software to modify the Completion Time-out range. Bits are one-hot encoded and set according to the table below to show time-out value ranges supported. A device that supports the optional capability of Completion Time-out Programmability must set at least two bits. Four time values ranges are defined: A: 50 μ s to 10 ms B: 10 ms to 250 ms C: 250 ms to 4 s D: 4 s to 64 s Bits are set according to table below to show time-out value ranges supported. 0000b = Completions Time-out programming not supported -- values is fixed by implementation in the range 50 μ s to 50 ms. 0001b = Range A 0010b = Range B 0011b = Range A & B 0110b = Range B & C 0111b = Range A, B, & C 1110b = Range B, C, & D 1111b = Range A, B, C & D All other values are reserved. Integrated I/O supports time-out values up to 10 ms-64 s.

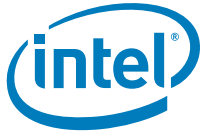

3.3.4.29 DEVCTRL2—PCI Express* Device Control Register 2

Register: DEVCTRL2 Device: 0 (DMI), 3, 5 (PCIe) Function: 0 Offset: B8h			
Bit	Attr	Default	Description
15:6	RO	0h	Reserved
5	RW	0	Alternative RID Interpretation (ARI) Enable When set to 1b, ARI is enabled for the Root Port.
4	RW	0	Completion Time-out Disable 1 = Disables the Completion Time-out mechanism for all NP tx that IIO issues on the PCI Express/DMI link. 0 = Completion time-out is enabled. Software can change this field while there is active traffic in the root port.
3:0	RW	0000b	Completion Time-out Value on NP Tx that Integrated I/O Issues on PCI Express/DMI – In Devices that support Completion Time-out programmability, this field allows system software to modify the Completion Time-out range. The following encodings and corresponding time-out ranges are defined: 0000b = 10 ms to 50 ms 0001b = Reserved (Integrated I/O aliases to 0000b) 0010b = Reserved (Integrated I/O aliases to 0000b) 0101b = 16 ms to 55 ms 0110b = 65 ms to 210 ms 1001b = 260 ms to 900 ms 1010b = 1 s to 3.5 s 1101b = 4 s to 13 s 1110b = 17 s to 64 s When the OS selects 17 s to 64 s range, the CTOCTRL register further controls the time-out value within that range. For all other ranges selected by OS, the time-out value within that range is fixed in Integrated I/O hardware. Software can change this field while there is active traffic in the root port.



3.3.4.30 LNKCON2—PCI Express* Link Control Register 2

Register: LNKCON2 Device: 0 (DMI), 3, 5 (PCIe) Function: 0 Offset: C0h			
Bit	Attr	Default	Description
15:13	RO	0	<i>Reserved</i>
12	RWS	0	Compliance De-Emphasis This bit sets the de-emphasis level in Polling Compliance state if the entry occurred due to the Enter Compliance bit being 1b. 1b = 3.5 dB 0b = 6 dB
11	RWS	0	Compliance SOS When set to 1, the LTSSM is required to send SKP Ordered Sets periodically in between the (modified) compliance patterns.
10	RWS	0	Enter Modified Compliance When this bit is set to 1, the device transmits Modified Compliance Pattern if the LTSSM enters Polling.Compliance substate.
9:7	RWS	0	Transmit Margin This field controls the value of the non de-emphasized voltage level at the Transmitter pins.
6	RWO	0	Selectable De-Emphasis When the Link is operating at 5.0 GT/s speed, this bit selects the level of de-emphasis for an Upstream component. Encodings: 1b = 3.5 dB 0b = 6 dB When the Link is operating at 2.5 GT/s speed, the setting of this bit has no effect.
5	RW	0	Hardware Autonomous Speed Disable When set to 1, this bit disables hardware from changing the Link speed for device specific reasons other than attempting to correct unreliable Link operation by reducing Link speed.
4	RWS	0	Enter Compliance Software is permitted to force a link to enter Compliance mode at the speed indicated in the Target Link Speed field by setting this bit to 1b in both components on a link and then initiating a hot reset on the link.
3:0	RWS	Dev0: 0001b Dev 3, 5: 0010b Dev 3,5: 0010b	Target Link Speed This field sets an upper limit on link operational speed by restricting the values advertised by the upstream component in its training sequences. Defined encodings are: 0001b = 2.5-Gb/s Target Link Speed 0010b = 5-Gb/s Target Link Speed All other encodings are reserved. If a value is written to this field that does not correspond to a speed included in the Supported Link Speeds field, Integrated I/O will default to Gen1 speed. This field is also used to set the target compliance mode speed when software is using the Enter Compliance bit to force a link into compliance mode.



3.3.4.31 LNKSTS2—PCI Express* Link Control Register 2

Register: LNKSTS2 Device: 0 (DMI), 3, 5 (PCIe) Function: 0 Offset: C2h			
Bit	Attr	Default	Description
15:1	RO	0	<i>Reserved</i>
0	RO	0	Compliance De-Emphasis Current de-emphasis level - when operating at Gen2 speed. This is unused in Gen1 speed. 1b = 3.5 dB 0b = 6 dB

3.3.4.32 PMCAP—Power Management Capabilities Register

The PM Capabilities Register defines the capability ID, next pointer and other power management related support. The following PM registers/capabilities are added for software compliance. For Device 0 DMI, this register should be RO and zero.

Register: PMCAP Device: 0 (DMI), 3, 5 (PCIe) Function: 0 Offset: E0h			
Bit	Attr	Default	Description
31:27	RO	11001	Power Management Event (PME) Support Bits 31, 30, and 27 must be set to 1 for PCI-to-PCI bridge structures representing ports on root complexes.
26	RO	0	D2 Support Integrated I/O does not support power management state D2.
25	RO	0	D1 Support Integrated I/O does not support power management state D1.
24:22	RO	0h	<i>Reserved</i>
21	RO	0	Device Specific Initialization
20	RV	0	<i>Reserved</i>
19	RO	0	PME Clock This field is hardwired to 0h as it does not apply to PCI Express.
18:16	RO	011	Version This field is set to 3h (PM 1.2 compliant) as version number for all PCI Express ports.
15:8	RO	00h	Next Capability Pointer This is the last capability in the chain and hence set to 0.
7:0	RO	01h	Capability ID Provides the PM capability ID assigned by PCI-SIG.



3.3.4.33 PMCSR—Power Management Control and Status Register (Device 0 DMI)

This register provides status and control information for PM events on the DMI port..

Register: PMCSR Device: 0 (DMI) Function: 0 Offset: E4h			
Bit	Attr	Default	Description
31:24	RO	00h	<i>Reserved</i>
23	RO	0h	Bus Power/Clock Control Enable This field is hardwired to 0h as it does not apply to PCI Express.
22	RO	0h	B2/B3 Support This field is hardwired to 0h as it does not apply to PCI Express.
21:16	RV	0h	<i>Reserved</i>
15	RO	0h	<i>Reserved</i>
14:13	RO	0h	<i>Reserved</i>
12:9	RO	0h	<i>Reserved</i>
8	RO	0h	<i>Reserved</i>
7:4	RV	0h	<i>Reserved</i>
3	RV	0h	<i>Reserved</i>
2	RV	0h	<i>Reserved</i>
1:0	RO	0h	Power State This 2-bit field is used to determine the current power state of the function and to set a new power state. 00 = D0 (default) 01 = D1 (not supported by Integrated I/O) 10 = D2 (not supported by Integrated I/O) 11 = D3hot If Software tries to write 01 or 10 to this field, the power state does not change from the existing power state (which is either D0 or D3hot) and nor do these bits change value.



3.3.4.34 PMCSR—Power Management Control and Status Register

This register provides status and control information for PM events in the PCI Express ports of the Integrated I/O.

Register: PMCSR Device: 3, 5 (PCIe) Function: 0 Offset: E4h			
Bit	Attr	Default	Description
31:24	RO	00h	<i>Reserved</i>
23	RO	0h	Bus Power/Clock Control Enable This field is hardwired to 0h as it does not apply to PCI Express.
22	RO	0h	<i>Reserved</i>
21:16	RV	0h	<i>Reserved</i>
15	RV	0h	<i>Reserved</i>
14:13	RO	0h	<i>Reserved</i>
12:9	RO	0h	<i>Reserved</i>
8	RWS	0h	<i>Reserved</i>
7:4	RV	0h	<i>Reserved</i>
3	RWO	1	<i>Reserved</i>
2	RV	0h	<i>Reserved</i>
1:0	RW	0h	Power State This 2-bit field is used to determine the current power state of the function and to set a new power state. 00 = D0 (default) 01 = D1 (not supported by Integrated I/O) 10 = D2 (not supported by Integrated I/O) 11 = D3hot If Software tries to write 01 or 10 to this field, the power state does not change from the existing power state (which is either D0 or D3hot) and nor do these bits change value.

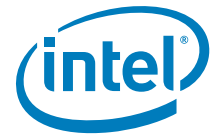

3.3.5 PCIe/DMI Extended Configuration Space

This section describes the extended configuration space (100h to 1FCh) for PCI Express and DMI ports.

3.3.5.1 APICBASE—APIC Base Register

Register: APICBASE Device: 0 (DMI), 3, 5 (PCIe) Function: 0 Offset: 140h			
Bit	Attr	Default	Description
15:12	RO	0h	Reserved
11:1	RW	0h	Bits 19:9 of the APIC Base Bits 31:20 are assumed to be FECh. Bits 8:0 are don't care for address decode. Address decoding to the APIC range is done as $APIC_BASE[31:8] \leq A[31:8] \leq APIC_LIMIT[31:8]$.
0	RW	0h	APIC Range Enable Enables the decode of the APIC window.

3.3.5.2 APICLIMIT—APIC Limit Register

Register: APICLIMIT Device: 0 (DMI), 3, 5 (PCIe) Function: 0 Offset: 142h			
Bit	Attr	Default	Description
15:12	RO	0h	Reserved
11:1	RW	0h	Bits 19:9 of the APIC Limit Bits 31:20 are assumed to be FECh. Bits 8:0 are a don't care for address decode. Address decoding to the APIC range is done as $APIC_BASE[31:8] \leq A[31:8] \leq APIC_LIMIT[31:8]$.
0	RO	0h	Reserved

3.3.5.3 PERFCTRLSTS—Performance Control and Status Register

(Sheet 1 of 2)

Register: PERFCTRLSTS Device: 0 (DMI), 3, 5 (PCIe) Function: 0 Offset: 180h			
Bit	Attr	Default	Description
63:42	RO	0	Reserved
41	RO	0	Reserved
40	RV	0	Reserved
39:36	RO	0	Reserved
35	RV	0	Reserved
34:21	RV	0	Reserved

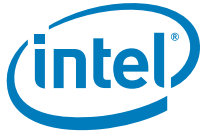

(Sheet 2 of 2)

Register: PERFCTRLSTS Device: 0 (DMI), 3, 5 (PCIe) Function: 0 Offset: 180h			
Bit	Attr	Default	Description
20:16	RW	18h	<p>Number of Outstanding RFOs/Pre-Allocated Non-Posted Requests for PCI Express Gen1</p> <p>This register controls the number of outstanding inbound non-posted requests - I/O, config, memory - that a Gen1 PCI Express downstream port can have, for all non-posted requests (peer-to-peer or to main-memory) it pre-allocates buffer space for. The value of this parameter for the port when operating in Gen1 x8 width is obtained by multiplying this register by 2 and 4, respectively. Software programs this register based on the read/RFO latency to main memory.</p> <p>A value of 1 indicates one outstanding pre-allocated request, 2 indicates 2 outstanding pre-allocated requests and so on. If software programs a value greater than the buffer size the DMA engine supports, then the maximum hardware supported value is used.</p>
15:14	RO	0	Reserved
13:8	RW	30h	<p>Number of Outstanding Pre-Allocated Non-Posted Requests for PCI Express Gen2</p> <p>This register controls the number of outstanding inbound non-posted requests - I/O, config, memory - (maximum length of these requests is a CL) that a Gen1 PCI Express downstream port can have, for all non-posted requests (peer-to-peer or to main-memory) it pre-allocates buffer space for. The value of this parameter for the port when operating in Gen2 width is obtained by multiplying this register by 2 and 4, respectively. Software programs this register based on the read/RFO latency to main memory.</p> <p>A value of 1 indicates one outstanding pre-allocated request, 2 indicates 2 outstanding pre-allocated requests and so on. If software programs a value greater than the buffer size the DMA engine supports, then the maximum hardware supported value is used.</p>
7	RO	0	Reserved
6	RO	0	Reserved
5	RO	0	Reserved
4	RO	0	Reserved
3	RW	0	<p>Enable No-Snoop Write Optimization on Writes</p> <p>When set, inbound writes to memory with NS=1 will be treated as non-coherent (no snoops) writes on Intel QuickPath Interconnect and pipelined to the processor node.</p> <p>Notes:</p> <ol style="list-style-type: none"> This bit should be set to the same value as Bit 2 (Enable No-Snoop Optimization on reads) of this register. This must be set for DMI port to support Isoch traffic. For PCI Express ports the NS optimization must not be used and this bit should be zero.
2	RW	0	<p>Enable No-Snoop Optimization on Reads</p> <p>When set, memory reads with NS=1 will not be snooped on Intel QuickPath Interconnect.</p> <p>Notes:</p> <ol style="list-style-type: none"> This bit should be set to the same value as Bit 3 (Enable No-Snoop Optimization on writes) of this register. This must be set for DMI port to support Isoch traffic. For PCI Express ports the NS optimization must not be used and this bit should be zero.
1	RO	0	Reserved
0	RO	0	Reserved

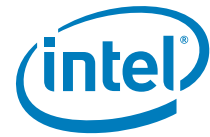

3.3.5.4 MISCTRLSTS—Miscellaneous Control and Status Register

(Sheet 1 of 3)

Register: MISCTRLSTS Device: 0 (DMI), 3, 5 (PCIe) Function: 0 Offset: 188h			
Bit	Attr	Default	Description
63:50	RO	0	Reserved
49	RW1CS	0	Reserved
48	RW1C	0	Received PME_TO_ACK Indicates that Integrated I/O received a PME turn off ACK packet or it timed out waiting for the packet.
47:38	RO	0	Reserved
37	RV	0	Reserved
36	RWS	0	Form-Factor Indicates what form-factor a particular root port controls 0 = CEM/Cable 1 = SIOM This bit is used to interpret bit 6 in the VPP serial stream for the port as either MRL# (CEM/Cable) input or EMLSTS# (SIOM) input.
35	RW	0	Override System Error on PCI Express Fatal Error Enable When set, fatal errors on PCI Express (that have been successfully propagated to the primary interface of the port) are sent to the Integrated I/O core error logic (for further escalation) regardless of the setting of the equivalent bit in the ROOTCON register. When clear, the fatal errors are only propagated to the Integrated I/O core error logic if the equivalent bit in ROOTCTRL register is set.
34	RW	0	Override System Error on PCI Express Non-Fatal Error Enable When set, non-fatal errors on PCI Express (that have been successfully propagated to the primary interface of the port) are sent to the Integrated I/O core error logic (for further escalation) regardless of the setting of the equivalent bit in the ROOTCON register. When clear, the non-fatal errors are only propagated to the Integrated I/O core error logic if the equivalent bit in ROOTCON register is set.
33	RW	0	Override System Error on PCI Express Correctable Error Enable When set, correctable errors on PCI Express (that have been successfully propagated to the primary interface of the port) are sent to the Integrated I/O core error logic (for further escalation) regardless of the setting of the equivalent bit in the ROOTCON register. When clear, the correctable errors are only propagated to the Integrated I/O core error logic if the equivalent bit in ROOTCON register is set.
32	RW	0	ACPI PME Interrupt Enable When set, Assert/Deassert_PMEGPE messages are enabled to be generated when ACPI mode is enabled for handling PME messages from PCI Express. When this bit is cleared (from a 1), a Deassert_PMEGPE message is scheduled on behalf of the root port if an Assert_PMEGPE message was sent earlier from the root port.
31	RW	0	Disable L0s on Transmitter When set, Integrated I/O never puts its tx in L0s state, even if OS enables it using the Link Control register.
30	RV	0	Reserved
29	RW	1	cfg_to_en Disables/enables configuration timeouts, independently of other timeouts.
28	RO	0	Reserved



(Sheet 2 of 3)

Register: MISCCTRLSTS Device: 0 (DMI), 3, 5 (PCIe) Function: 0 Offset: 188h			
Bit	Attr	Default	Description
27	RWS	0	System Interrupt Only on Link BW/Management Status This bit, when set, will disable generating MSI interrupt on link bandwidth (speed and/or width) and management changes, even if MSI is enabled that is, will disable generating MSI when LNKSTS Bits 15 and 14 are set.
26	RW	0	Disable EOI Broadcast to this PCI Express link When set, EOI message will not be broadcast down this PCI Express link. When clear, the port is a valid target for EOI broadcast.
25	RW	0	Peer-to-Peer Memory Write Disable When set, peer-to-peer memory writes are master aborted otherwise they are allowed to progress per the peer-to-peer decoding rules.
24	RV	1	<i>Reserved</i>
23	RW	0	Phold Disable When set, the IIO responds with unsupported request on receiving assert_phold message from PCH and results in generating a fatal error.
22:10	RV	--	<i>Reserved</i>
9	RV	0	<i>Reserved</i>
8:7	RW	0	PME_TO_ACK Time-out Control This field sets the time-out value for receiving a PME_TO_ACK message after a PME_TURN_OFF message has been transmitted. This field has meaning only if bit 6 is set to a 0b. 00 = 1 ms 01 = 10 ms 10 = 50 ms 11 = test mode
6	RW	0	Disable Time-out for Receiving PME_TO_ACK When set, IIO disables the time-out to receiving the PME_TO_ACK.
5	RW	0	Send PME_TURN_OFF Message When this bit is written with a 1, IIO sends a PME_TURN_OFF message to the PCI Express link. Hardware clears this bit when the message has been sent on the link.
4	RW	0	When set, the PCI Express errors do not trigger an MSI interrupt, regardless of the whether MSI is enabled or not. When this bit is cleared, PCI Express errors are reported using MSI and/or NMI/SMI/MCA. When this bit is clear and if MSI enable bit in the MSICTRL register is set, then an MSI interrupt is generated for PCI Express errors. When this bit is clear, and 'System Error on Fatal Error Enable' bit in Section 3.3.4.25, "ROOTCON—PCI Express* Root Control Register" is set, then NMI/SMI/MCA is (also) generated for a PCI Express fatal error. Similar behavior for non-fatal and corrected errors.
3	RW	0	<i>Reserved</i>
2	RW	0	Enable ACPI Mode for PM When set, all PM events at the PCI Express port are handled using _PMEGPE messages to the PCH, and no MSI interrupts are ever generated for PM events at the root port (regardless of whether MSI is enabled at the root port or not). When clear, _PMEGPE message generation for PM events is disabled and OS can choose to generate MSI interrupts for delivering PM events by setting the MSI enable bit in root ports. This bit does not apply to the DMI ports. Clearing this bit (from being 1) schedules a Deassert_PMEGPE event on behalf of the root port, provided there was any previous Assert_PMEGPE message that was sent without an associated Deassert message.

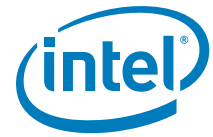

(Sheet 3 of 3)

Register: MISCCTRLSTS Device: 0 (DMI), 3, 5 (PCIe) Function: 0 Offset: 188h			
Bit	Attr	Default	Description
1	RWO	0h	Inbound Configuration Enable When clear, all inbound configuration transactions are sent a UR response by the receiving PCI Express port. When set, inbound configs are allowed. Note: Enabling is only for debug purposes.
0	Dev:attr 0:RO else:RW	Dev:val 0:1 else: 0	Set Host Bridge Class Code When this bit is set, the class code register indicates "Host Bridge".

3.3.5.5 CTOCTRL—Completion Time-out Control Register

Register: CTOCTRL Device: 0 (DMI), 3, 5 (PCIe) Function: 0 Offset: 1E0h			
Bit	Attr	Default	Description
31:10	RV	00	<i>Reserved</i>
9:8	RW	00	XP-to-PCIe Time-out Select within 17 s to 64 s Range When OS selects a time-out range of 17 s to 64 s for Windows* XP (that affect NP tx issued to the PCI Express/DMI) using the root port's DEVCTRL2 register, this field selects the sub-range within that larger range, for additional controllability. 00 = 17 s-30 s 01 = 31 s-45 s 10 = 46 s-64 s 11 = Reserved Note: This field is subject to redefinition based on design feedback.
7:0	RV	00	<i>Reserved</i>



3.3.6 DMI Root Complex Register Block

This block is mapped into memory space, using register DMIRCBAR [Dev0:F0, offset 50h].

Table 3-6. DMI RCRB Registers

DMIVCH	00h		80h
DMIVCCAP1	04h	DMILCAP	
DMIVCCAP2	08h	DMILSTS	DMILCTRL
DMIVCCTL	0Ch		
DMIVCORCAP	10h		
DMIVCORCTL	14h		
DMIVCORSTS	18h		
DMIVC1RCAP	1Ch		
DMIVC1RCTL	20h		
DMIVC1RSTS	24h		
	28h		
	2Ch		
	30h		
	34h		
	38h		
	3Ch		
	40h		
	44h		
	48h		
	4Ch		
	50h		
	54h		
	58h		
	5Ch		
	60h		
	64h		
	68h		
	6Ch		
	70h		
	74h		
	78h		
	7Ch		
		84h	
		88h	
		8Ch	
		90h	
		94h	
		98h	
		9Ch	
		A0h	
		A4h	
		A8h	
		ACh	
		B0h	
		B4h	
		B8h	
		BCh	
		C0h	
		C4h	
		C8h	
		CCh	
		D0h	
		D4h	
		D8h	
		DCh	
		E0h	
		E4h	
		E8h	
		ECh	
		F0h	
		F4h	
		F8h	
		FCh	

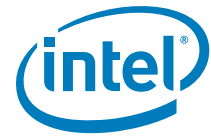

3.3.6.1 DMIVCH—DMI Virtual Channel Capability Header

This register Indicates DMI Virtual Channel capabilities.

BAR: DMIRCBAR Register: DMIVCH Offset: 0000h			
Bit	Attr	Default	Description
31:20	RO	040h	Pointer to Next Capability (PNC) This field contains the offset to the next PCI Express capability structure in the linked list of capabilities (Link Declaration Capability).
19:16	RO	1h	PCI Express Virtual Channel Capability Version (PCIEVCCV) Hardwired to 1 to indicate compliances with the 1.1 version of the PCI Express specification.
15:0	RO	0002h	Extended Capability ID (ECID) Value of 0002 h identifies this linked list item (capability structure) as being for PCI Express Virtual Channel registers.

3.3.6.2 DMIVCCAP1—DMI Port VC Capability Register 1

This register describes the configuration of PCI Express Virtual Channels associated with the DMI port.

BAR: DMIRCBAR Register: DMIVCCAP1 Offset: 0004h			
Bit	Attr	Default	Description
31:7	RV	0	<i>Reserved</i>
6:4	RO	0	Low Priority Extended VC Count (LPEVCC) Indicates the number of (extended) Virtual Channels in addition to the default VC belonging to the low-priority VC (LPVC) group that has the lowest priority with respect to other VC resources in a strict-priority VC Arbitration. The value of 0 in this field implies strict VC arbitration.
3	RO	0	<i>Reserved</i>
2:0	RWO	001b	Extended VC Count (EVCC) Indicates the number of (extended) Virtual Channels in addition to the default VC supported by the device. The Private Virtual Channel is not included in this count.



3.3.6.3 DMIVCCAP2—DMI Port VC Capability Register 2

This register Describes the configuration of PCI Express Virtual Channels associated with this port.

BAR: DMIRCBAR Register: DMIVCCAP2 Offset: 0008h			
Bit	Attr	Default	Description
31:24	RO	0h	Reserved for VC Arbitration Table Offset
23:8	RO	0h	<i>Reserved</i>
7:0	RO	0h	<i>Reserved</i> for VC Arbitration Capability (VCAC)

3.3.6.4 DMIVCCTL—DMI Port VC Control

BAR: DMIRCBAR Register: DMIVCCTL Offset: 000Ch			
Bit	Attr	Default	Description
15:4	RO	0h	<i>Reserved</i>
3:1	RW	0h	VC Arbitration Select (VCAS) This field will be programmed by software to the only possible value as indicated in the VC Arbitration Capability field. The value 000b when written to this field will indicate the VC arbitration scheme is hardware fixed (in the root complex). This field cannot be modified when more than one VC in the LPVC group is enabled. 000 = Hardware fixed arbitration scheme, for example, Round Robin Others = Reserved Refer to the latest <i>PCI Express Base Specification</i> for more details.
0	RO	0h	<i>Reserved</i> for Load VC Arbitration Table

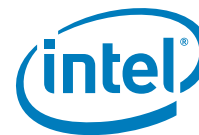

3.3.6.5 DMIVCORCAP—DMI VCO Resource Capability

BAR: DMIRCBAR Register: DMIVCORCAP Offset: 0010h			
Bit	Attr	Default	Description
31:24	RO	0h	Reserved for Port Arbitration Table Offset
23	RO	0	<i>Reserved</i>
22:16	RO	0h	<i>Reserved</i> for Maximum Time Slots
15	RO	0h	Reject Snoop Transactions (REJSNPT) 0 = Transactions with or without the No Snoop bit set within the TLP header are allowed on this VC. 1 = Any transaction without the No Snoop bit set within the TLP header will be rejected as an Unsupported Request.
14:8	RO	0h	<i>Reserved</i>
7:0	RO	01h	Port Arbitration Capability (PAC) Having only Bit 0 set indicates that the only supported arbitration scheme for this VC is non-configurable hardware-fixed.

3.3.6.6 DMIVCORCTL—DMI VCO Resource Control

Controls the resources associated with PCI Express Virtual Channel 0.

BAR: DMIRCBAR Register: DMIVCORCTL Offset: 0014h			
Bit	Attr	Default	Description
31	RO	1	Virtual Channel 0 Enable (VCOE) For VCO, this is hardwired to 1 and read only as VCO can never be disabled.
30:27	RO	0h	<i>Reserved</i>
26:24	RO	0h	Virtual Channel 0 ID (VCOID) Assigns a VC ID to the VC resource. For VCO this is hardwired to 0 and read only.
23:20	RO	0h	<i>Reserved</i>
19:17	RW	0h	Port Arbitration Select (PAS) Configures the VC resource to provide a particular Port Arbitration service. Valid value for this field is a number corresponding to one of the asserted bits in the Port Arbitration Capability field of the VC resource. Because only bit 0 of that field is asserted. This field will always be programmed to 1.
16:8	RO	0h	<i>Reserved</i>
7:1	RW	7Fh	Traffic Class/Virtual Channel 0 Map (TCVCOM) Indicates the TCs (Traffic Classes) that are mapped to the VC resource. Bit locations within this field correspond to TC values. For example, when Bit 7 is set in this field, TC7 is mapped to this VC resource. When more than one bit in this field is set, it indicates that multiple TCs are mapped to the VC resource. In order to remove one or more TCs from the TC/VC Map of an enabled VC, software must ensure that no new or outstanding transactions with the TC labels are targeted at the given Link.
0	RO	1	Traffic Class 0/Virtual Channel 0 Map (TCOVCOM) Traffic Class 0 is always routed to VCO.



3.3.6.7 DMIVCORSTS—DMI VCO Resource Status

Reports the Virtual Channel specific status.

BAR: DMIRCBAR Register: DMIVCORSTS Offset: 001Ah			
Bit	Attr	Default	Description
15:2	RO	0h	<i>Reserved.</i> Reserved and Zero for future R/WC/S implementations. Software must use 0 for writes to these bits.
1	RO	1b	Virtual Channel 0 Negotiation Pending (VCONP) 0 = The VC negotiation is complete. 1 = The VC resource is still in the process of negotiation (initialization or disabling). This bit indicates the status of the process of Flow Control initialization. It is set by default on Reset, as well as whenever the corresponding Virtual Channel is Disabled or the Link is in the DL_Down state. It is cleared when the link successfully exits the FC_INIT2 state. BIOS Requirement: Before using a Virtual Channel, software must check whether the VC Negotiation Pending fields for that Virtual Channel are cleared in both Components on a Link.
0	RO	0b	<i>Reserved</i>

3.3.6.8 DMIVC1RCAP—DMI VC1 Resource Capability

BAR: DMIRCBAR Register: DMIVC1RCAP Offset: 001Ch			
Bit	Attr	Default	Description
31:24	RO	0h	Reserved for Port Arbitration Table Offset
23	RO	0	<i>Reserved</i>
22:16	RO	0h	<i>Reserved</i> for Maximum Time Slots
15	RO	0h	Reject Snoop Transactions (REJSNPT) 0 = Transactions with or without the No Snoop bit set within the TLP header are allowed on this VC. 1 = Any transaction without the No Snoop bit set within the TLP header will be rejected as an Unsupported Request.
14:8	RO	0h	<i>Reserved</i>
7:0	RO	01h	Port Arbitration Capability (PAC) Having only Bit 0 set indicates that the only supported arbitration scheme for this VC is non-configurable hardware-fixed.

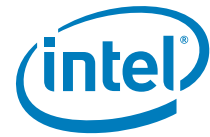

3.3.6.9 DMIVC1RCTL—DMI VC1 Resource Control

Controls the resources associated with PCI Express Virtual Channel 1.

BAR: DMIRCBAR Register: DMIVC1RCTL Offset: 0020h			
Bit	Attr	Default	Description
31	RW	0	Virtual Channel 1 Enable (VC1E) 0 = Virtual Channel is disabled. 1 = Virtual Channel is enabled. See exceptions below. Software must use the VC Negotiation Pending bit to check whether the VC negotiation is complete. When VC Negotiation Pending bit is cleared, a 1 read from this VC Enable bit indicates that the VC is enabled (Flow Control Initialization is completed for the PCI Express port). A 0 read from this bit indicates that the Virtual Channel is currently disabled. BIOS Requirement: <ol style="list-style-type: none"> To enable a Virtual Channel, the VC Enable bits for that Virtual Channel must be set in both Components on a Link. To disable a Virtual Channel, the VC Enable bits for that Virtual Channel must be cleared in both Components on a Link. Software must ensure that no traffic is using a Virtual Channel at the time it is disabled. Software must fully disable a Virtual Channel in both Components on a Link before re-enabling the Virtual Channel.
30:27	RO	0h	<i>Reserved</i>
26:24	RW	001b	Virtual Channel 1 ID (VC1ID) Assigns a VC ID to the VC resource. Assigned value must be non-zero. This field can not be modified when the VC is already enabled.
23:20	RO	0h	<i>Reserved</i>
19:17	RW	0h	Port Arbitration Select (PAS) Configures the VC resource to provide a particular Port Arbitration service. Valid value for this field is a number corresponding to one of the asserted bits in the Port Arbitration Capability field of the VC resource.
16:8	RO	0h	<i>Reserved</i>
7:1	RW	00h	Traffic Class / Virtual Channel 1 Map (TCVC1M) Indicates the TCs (Traffic Classes) that are mapped to the VC resource. Bit locations within this field correspond to TC values. For example, when Bit 7 is set in this field, TC7 is mapped to this VC resource. When more than one bit in this field is set, it indicates that multiple TCs are mapped to the VC resource. In order to remove one or more TCs from the TC/VC Map of an enabled VC, software must ensure that no new or outstanding transactions with the TC labels are targeted at the given Link.
0	RO	0	Traffic Class 0/Virtual Channel 0 Map (TC0VC1M) Traffic Class 0 is always routed to VC0.

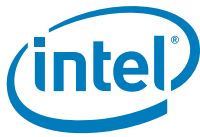

3.3.6.10 DMIVC1RSTS—DMI VC1 Resource Status

Reports the Virtual Channel specific status.

BAR: DMIRCBAR Register: DMIVC1RSTS Offset: 0026h			
Bit	Attr	Default	Description
15:2	RO	0h	<i>Reserved.</i> Reserved and Zero for future R/WC/S implementations. Software must use 0 for writes to these bits.
1	RO	1	Virtual Channel 1 Negotiation Pending (VC1NP): 0 = The VC negotiation is complete. 1 = The VC resource is still in the process of negotiation (initialization or disabling). This bit indicates the status of the process of Flow Control initialization. It is set by default on Reset, as well as whenever the corresponding Virtual Channel is Disabled or the Link is in the DL_Down state. It is cleared when the link successfully exits the FC_INIT2 state. BIOS Requirement: Before using a Virtual Channel, software must check whether the VC Negotiation Pending fields for that Virtual Channel are cleared in both Components on a Link.
0	RO	0	<i>Reserved</i>

3.3.6.11 DMILCAP—DMI Link Capabilities

Indicates DMI specific capabilities.

BAR: DMIRCBAR Register: DMILCAP Offset: 0084h			
Bit	Attr	Default	Description
31:18	RO	0h	<i>Reserved</i>
17:15	RWO	010	L1 Exit Latency (EL1) Default value of 010b indicates that the exit latency is 2 μ s to 4 μ s.
14:12	RWO	7h	L0s Exit Latency
11:10	RO	11b	Active State Link PM Support (ASLPMS) L0s and L1 entry supported.
9:4	RO	04h	Max Link Width (MLW) Indicates the maximum number of lanes supported for this link.
3:0	RO	1h	Max Link Speed (MLS) Hardwired to indicate 2.5 Gb/s.

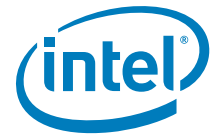

3.3.6.12 DMILCTRL—DMI Link Control

This register allows control of DMI.

BAR: DMIRCBAR Register: DMILCTRL Offset: 0088h			
Bit	Attr	Default	Description
15:8	RO	0h	<i>Reserved</i>
7	RW	0	Extended Synch (EXTSYNC) 0 = Standard Fast Training Sequence (FTS). 1 = Forces the transmission of additional ordered sets when exiting the L0s state and when in the Recovery state. This mode provides external devices (for example, logic analyzers) monitoring the Link time to achieve bit and symbol lock before the link enters L0 and resumes communication. This is a test mode only and may cause other undesired side effects such as buffer overflows or underruns.
6:2	RO	0h	<i>Reserved</i>
1:0	RW	00b	Active State Power Management Support (ASPMS) This field controls the level of active state power management supported on the given link. 00 = Disabled 01 = L0s Entry Supported 10 = Reserved 11 = L0s and L1 Entry Supported

3.3.6.13 DMILSTS—DMI Link Status

This register indicates DMI status.

BAR: DMIRCBAR Register: DMILSTS Offset: 008Ah			
Bit	Attr	Default	Description
15:10	RO	0h	<i>Reserved</i>
9:4	RO	00h	Negotiated Width (NWID) Indicates negotiated link width. This field is valid only when the link is in the L0, L0s, or L1 states (after link width negotiation is successfully completed). 00h = Reserved 01h = X1 02h = X2 04h = X4 All other encodings are reserved.
3:0	RO	1h	Negotiated Speed (NSPD) Indicates negotiated link speed. 1h = 2.5 Gb/s All other encodings are reserved.



3.4 Integrated I/O Core Registers (Device 8, Function 0-3)

This section describes the standard PCI configuration registers and device specific Configuration Registers related to below:

- Intel VT-d, address mapping, system management — Device 8, Function 0
- Semaphore and Scratchpad — Device 8, Function 1
- System control/status — Device 8, Function 2
- Miscellaneous Registers — Device 8, Function 3

3.4.1 Configuration Register Map (Device 8, Function 0-3)

Table 3-7. Core Registers (Device 8, Function 0) — Offset 000h–0FFh

DID	VID		00h		80h		
PCISTS	PCICMD		04h		84h		
CCR	RID		08h		88h		
HDR	CLSR		0Ch		8Ch		
			10h		90h		
			14h		94h		
			18h		IOMISCCTRL	98h	
			1Ch		IOMISCSS	9Ch	
			20h				A0h
			24h				A4h
			28h	TSEGCTRL	A8h		
SID		SVID	2Ch		ACh		
			30h		B0h		
CAPPTR ¹			34h		B4h		
			38h		B8h		
INTPIN		INTLIN	3Ch		BCh		
EXPCAP	NXTPTR	CAPID	40h		C0h		
DEVCAP			44h		C4h		
DEVSTS	DEVCTRL		48h		C8h		
RESERVEDPCI Express Header space			4Ch		CCh		
			50h		TOLM	D0h	
			54h	TOHM		D4h	
			58h			D8h	
			5Ch	NCMEM.BASE		DCh	
			60h	NCMEM.LIMIT		E0h	
			64h			E4h	
			68h			E8h	
			6Ch			ECh	
			70h	DEVHIDE 1		F0h	
74h			F4h				
78h	DEVHIDE 2		F8h				
			7Ch	FCh			

Notes:

1. CAPPTR points to the first capability block.

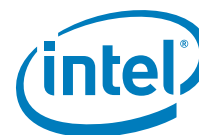

Table 3-8. Core Registers (Device 8, Function 0) – Offset 100h–1FFh

Reserved for PCI Express header space		100h	VTBAR		180h	
		104h		VTGENCTRL	184h	
IIOBUSNO		108h	VTISOCHCTRL		188h	
LMMIOL.LIMIT	LMMIOL.BASE	10Ch	VTGENCTRL2		18Ch	
LMMIOH.LIMIT	LMMIOH.BASE	110h	VTSTS		190h	
LMMIOH.BASEU		114h			194h	
LMMIOH.LIMITU		118h			198h	
	LCFGBUS.LIMIT	LCFGBUS.BASE			11Ch	19Ch
		120h			1A0h	
GMMIOL.LIMIT	GMMIOL.BASE	124h			1A4h	
GMMIOH.LIMIT	GMMIOH.BASE	128h			1A8h	
GMMIOH.BASEU		12Ch			1ACh	
GMMIOH.LIMITU		130h			1B0h	
	GCFGBUS.LIMIT	GCFGBUS.BASE			134h	1B4h
MESEGBASE		138h			1B8h	
		13Ch			1BCh	
MESEGMASK		140h			1C0h	
		144h			1C4h	
		148h			1C8h	
		14Ch			1CCh	
		150h			1D0h	
		154h			1D4h	
		158h			1D8h	
		15Ch			1DCh	
		160h			1E0h	
		164h	1E4h			
		168h	1E8h			
		16Ch	1ECh			
		170h	1F0h			
		174h	1F4h			
		178h	1F8h			
		17Ch	1FCh			



Table 3-9. Core Registers (Device 8, Function 1) — Semaphore and ScratchPad Registers (Sheet 1 of 2)

DID	VID		000h	SR[1]	080h			
PCISTS	PCICMD		004h	SR[2]	084h			
CCR		RID	008h	SR[3]	088h			
HDR	CLSR		00Ch	SR[4]	08Ch			
			010h	SR[5]	090h			
			014h	SR[6]	094h			
			018h	SR[7]	098h			
			01Ch	SR[8]	09Ch			
			020h	SR[9]	0A0h			
			024h	SR[10]	0A4h			
			028h	SR[11]	0A8h			
			SID	SVID	02Ch	SR[12]	0ACh	
						030h	SR[13]	0B0h
						CAPPTR ¹	034h	SR[14]
			038h	SR[15]	0B8h			
		INTPIN	INTLIN	03Ch	SR[16]	0BCh		
EXPCAP	NXTPTR	CAPID	040h	SR[17]	0C0h			
DEVCAP			044h	SR[18]	0C4h			
DEVSTS	DEVCTRL		048h	SR[19]	0C8h			
RESERVEDPCI Express Header space			04Ch	SR[20]	0CCh			
			050h	SR[21]	0D0h			
			054h	SR[22]	0D4h			
			058h	SR[23]	0D8h			
			05Ch	CWR[0]	0DCh			
			060h	CWR[1]	0E0h			
			064h	CWR[2]	0E4h			
			068h	CWR[3]	0E8h			
			06Ch	CWR[4]	0ECh			
			070h	CWR[5]	0F0h			
074h	CWR[6]	0F4h						
078h	CWR[7]	0F8h						
SR[0]			07Ch	CWR[8]	0FCh			

Notes:

1. CAPPTR points to the first capability block.

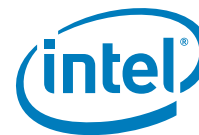

Table 3-10. Core Registers (Device 8, Function 1) — Semaphore and ScratchPad Registers (Sheet 2 of 2)

RESERVEDPCI Express Header space	100h	IR[16]	180h
CWR[9]	104h	IR[17]	184h
CWR[10]	108h	IR[18]	188h
CWR[11]	10Ch	IR[19]	18Ch
CWR[12]	110h	IR[20]	190h
CWR[13]	114h	IR[21]	194h
CWR[14]	118h	IR[22]	198h
CWR[15]	11Ch	IR[23]	19Ch
CWR[16]	120h		1A0h
CWR[17]	124h		1A4h
CWR[18]	128h		1A8h
CWR[19]	12Ch		1ACh
CWR[20]	130h		1B0h
CWR[21]	134h		1B4h
CWR[22]	138h		1B8h
CWR[23]	13Ch		1BCh
IR[0]	140h		1C0h
IR[1]	144h		1C4h
IR[2]	148h		1C8h
IR[3]	14Ch		1CCh
IR[4]	150h		1D0h
IR[5]	154h		1D4h
IR[6]	158h		1D8h
IR[7]	15Ch		1DCh
IR[8]	160h		1E0h
IR[9]	164h		1E4h
IR[10]	168h		1E8h
IR[11]	16Ch		1ECh
IR[12]	170h		1F0h
IR[13]	174h		1F4h
IR[14]	178h		1F8h
IR[15]	17Ch	1FCh	

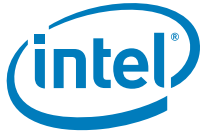

Table 3-11. Core Registers (Device 8, Function 2) — System Control/Status Registers

DID	VID	000h		080h	
PCISTS	PCICMD	004h		084h	
CCR	RID	008h		088h	
HDR	CLSR	00Ch		08Ch	
		010h		090h	
		014h		094h	
		018h		098h	
		01Ch		SYSMAP	09Ch
		020h			0A0h
		024h			0A4h
		028h	0A8h		
SID	SVID	02Ch	0ACh		
		030h	0B0h		
		CAPPTR ¹	034h	0B4h	
		038h	0B8h		
	INTPIN	INTLIN	03Ch	0BCh	
EXPCAP	NXTPTR	CAPID	040h	0C0h	
DEVCAP		044h	GENMCA	0C4h	
DEVSTS	DEVCTRL	048h		0C8h	
RESERVEDPCI Express Header space		04Ch	SYRE	0CCh	
		050h		0D0h	
		054h		0D4h	
		058h		0D8h	
		05Ch		0DCh	
		060h		0E0h	
		064h		0E4h	
		068h		0E8h	
		06Ch		0ECh	
		070h		0F0h	
074h	0F4h				
078h	0F8h				
		07Ch	0FCh		

Notes:

1. CAPPTR points to the first capability block.

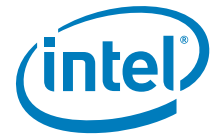

Table 3-12. Core Registers (Device 8, Function 3) – Miscellaneous Registers

DID	VID	00h		80h
PCISTS	PCICMD	04h		84h
CCR		RID		88h
HDR				8Ch
				90h
				94h
				98h
				9Ch
				A0h
				A4h
				A8h
SID		SVID		ACh
				B0h
				B4h
				B8h
				BCh
				C0h
				C4h
				C8h
				CCh
				D0h
				D4h
			PMUSTATE	D8h
				DCh
IIOSLPSTS_L				E0h
IIOSLPSTS_H				E4h
				E8h
				ECh
				F0h
		CTCTRL	CTSTS	F4h
				F8h
				FCh



3.4.2 Standard PCI Configuration Registers

3.4.2.1 VID—Vendor Identification Register

Read only Vendor ID (Intel) value.

Register: VID Device: 8 Function: 0-3 Offset: 00h			
Bit	Attr	Default	Description
15:0	RO	8086h	Vendor Identification Number (VID) PCI Standard Identification for Intel.

3.4.2.2 DID—Device Identification Register

Register: DID Device: 8 Function: 0-3 Offset: 02h			
Bit	Attr	Default	Description
15:0	RO	D155h (F:0) D156h (F:1) D157h (F:2) D158h (F:3)	Device Identification Number Identifier assigned to the product. Integrated I/O will have a unique device id for each device. The value is assigned by Intel to each product. Integrated I/O will have a unique device ID for each of its single function devices and a unique device ID for each function in the multi-function devices.

3.4.2.3 PCICMD—PCI Command Register

This register defines the PCI 3.0 compatible command register values applicable to PCI Express space.

(Sheet 1 of 3)

Register: PCICMD Device: 8 Function: 0-3 Offset: 04h			
Bit	Attr	Default	Description
15:11	RV	00h	<i>Reserved</i>
10	RO	0	INTDIS: Interrupt Disable This bit does not affect the ability of the Express port to route interrupt messages received at the PCI Express* port. 0 = Legacy Interrupt message generation is enabled. 1 = Legacy Interrupt message generation is disabled.
9	RO	0	Fast Back-to-Back Enable Not applicable to PCI Express and is hardwired to 0.

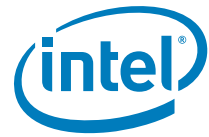

(Sheet 2 of 3)

Register: PCI_CMD Device: 8 Function: 0-3 Offset: 04h			
Bit	Attr	Default	Description
8	RO	0	SERR Enable For PCI Express/DMI ports, this field enables notifying the internal core error logic of occurrence of an uncorrectable error (fatal or non-fatal) at the port. The internal core error logic of Integrated I/O then decides if/how to escalate the error further (pins/message and so forth). This bit also controls the propagation of PCI Express ERR_FATAL and ERR_NONFATAL messages received from the port to the internal Integrated I/O core error logic. 0 = Fatal and Non-fatal error generation and Fatal and Non-fatal error message forwarding is disabled. 1 = Fatal and Non-fatal error generation and Fatal and Non-fatal error message forwarding is enabled. Refer to the latest <i>PCI Express Base Specification</i> for details of how this bit is used in conjunction with other control bits in the Root Control register for forwarding errors detected on the PCI Express interface to the system core error logic.
7	RO	0	IDSEL Stepping/Wait Cycle Control Not applicable to internal Integrated I/O devices. Hardwired to 0.
6	RO	0	Parity Error Response For PCI Express/DMI ports, Integrated I/O ignores this bit and always does ECC/parity checking and signaling for data/address of transactions both to and from Integrated I/O.
5	RO	0	VGA Palette Snoop Enable Not applicable to internal Integrated I/O devices. Hardwired to 0.
4	RO	0	Memory Write and Invalidate Enable Not applicable to internal Integrated I/O devices. Hardwired to 0.
3	RO	0	Special Cycle Enable Not applicable to PCI Express. Hardwired to 0.
2	RO	0	Bus Master Enable Controls the ability of the PCI Express port in generating/forwarding memory (including MSI writes) or I/O transactions (and not messages) or configuration transactions from the secondary side to the primary side. 0 = The Bus Master is disabled. When this bit is 0, Integrated I/O root ports will treat upstream PCI Express memory writes/reads, IO writes/reads, and configuration reads and writes as unsupported requests (and follow the rules for handling unsupported requests). This behavior is also true towards transactions that are already pending in the Integrated I/O root port's internal queues when the BME bit is turned off. 1 = Enables the PCI Express ports to generate/forward memory, configuration, or I/O read/write requests.
1	RO	0	Memory Space Enable 0 = Disables a PCI Express port's memory range registers to be decoded as valid target addresses for transactions from primary side. 1 = Enables a PCI Express port's memory range registers to be decoded as valid target addresses for transactions from primary side. Note that if a PCI Express port's MSE bit is clear, that port can still be target of any memory transaction if subtractive decoding is enabled on that port.



(Sheet 2 of 3)

Register: PCI_CMD Device: 8 Function: 0-3 Offset: 04h			
Bit	Attr	Default	Description
8	RO	0	<p>SERR Enable</p> <p>For PCI Express/DMI ports, this field enables notifying the internal core error logic of occurrence of an uncorrectable error (fatal or non-fatal) at the port. The internal core error logic of Integrated I/O then decides if/how to escalate the error further (pins/message and so forth). This bit also controls the propagation of PCI Express ERR_FATAL and ERR_NONFATAL messages received from the port to the internal Integrated I/O core error logic.</p> <p>0 = Fatal and Non-fatal error generation and Fatal and Non-fatal error message forwarding is disabled. 1 = Fatal and Non-fatal error generation and Fatal and Non-fatal error message forwarding is enabled.</p> <p>Refer to the latest <i>PCI Express Base Specification</i> for details of how this bit is used in conjunction with other control bits in the Root Control register for forwarding errors detected on the PCI Express interface to the system core error logic.</p>
7	RO	0	<p>IDSEL Stepping/Wait Cycle Control</p> <p>Not applicable to internal Integrated I/O devices. Hardwired to 0.</p>
6	RO	0	<p>Parity Error Response</p> <p>For PCI Express/DMI ports, Integrated I/O ignores this bit and always does ECC/parity checking and signaling for data/address of transactions both to and from Integrated I/O.</p>
5	RO	0	<p>VGA Palette Snoop Enable</p> <p>Not applicable to internal Integrated I/O devices. Hardwired to 0.</p>
4	RO	0	<p>Memory Write and Invalidate Enable</p> <p>Not applicable to internal Integrated I/O devices. Hardwired to 0.</p>
3	RO	0	<p>Special Cycle Enable</p> <p>Not applicable to PCI Express. Hardwired to 0.</p>
2	RO	0	<p>Bus Master Enable</p> <p>Controls the ability of the PCI Express port in generating/forwarding memory (including MSI writes) or I/O transactions (and not messages) or configuration transactions from the secondary side to the primary side.</p> <p>0 = The Bus Master is disabled. When this bit is 0, Integrated I/O root ports will treat upstream PCI Express memory writes/reads, IO writes/reads, and configuration reads and writes as unsupported requests (and follow the rules for handling unsupported requests). This behavior is also true towards transactions that are already pending in the Integrated I/O root port's internal queues when the BME bit is turned off.</p> <p>1 = Enables the PCI Express ports to generate/forward memory, configuration, or I/O read/write requests.</p>
1	RO	0	<p>Memory Space Enable</p> <p>0 = Disables a PCI Express port's memory range registers to be decoded as valid target addresses for transactions from primary side. 1 = Enables a PCI Express port's memory range registers to be decoded as valid target addresses for transactions from primary side.</p> <p>Note that if a PCI Express port's MSE bit is clear, that port can still be target of any memory transaction if subtractive decoding is enabled on that port.</p>



(Sheet 3 of 3)

Register: PCICMD Device: 8 Function: 0-3 Offset: 04h			
Bit	Attr	Default	Description
0	RO	0	IO Space Enable Applies only to PCI Express/DMI ports 0 = Disables the I/O address range, defined in the IOBASE and IOLIM registers of the PCI-to-PCI bridge header, for target decode from primary side. 1 = Enables the I/O address range, defined in the IOBASE and IOLIM registers of the PCI-to-PCI bridge header, for target decode from primary side. Note that if a PCI Express/DMI port's IOSE bit is clear, that port can still be target of an I/O transaction if subtractive decoding is enabled on that port.

3.4.2.4 PCISTS—PCI Status Register

The PCI Status register is a 16-bit status register that typically reports the occurrence of various events associated with the primary side of the “virtual” PCI Express device. Since these devices are host bridge devices, the only field that has meaning is “Capabilities List.”

(Sheet 1 of 2)

Register: PCISTS Device: 8 Function: 0-3 Offset: 06h			
Bit	Attr	Default	Description
15	RO	0	Detected Parity Error This bit is set by a device when it receives a packet on the primary side with an uncorrectable data error or an uncorrectable address/control parity error. The setting of this bit is regardless of the Parity Error Response bit (PERRE) in the PCICMD register.
14	RO	0	Signaled System Error 0 = The device did not report a fatal/non-fatal error 1 = The device reported fatal/non-fatal (and not correctable) errors it detected on its PCI Express interface. Software clears this bit by writing a 1 to it. For Express ports, this bit is also set (when SERR enable bit is set) when a FATAL/NON-FATAL message is forwarded from the Express link
13	RO	0	Received Master Abort This bit is set when a device experiences a master abort condition on a transaction it mastered on the primary interface (Integrated I/O internal bus). Note that certain errors might be detected right at the PCI Express interface and those transactions might not ‘propagate’ to the primary interface before the error is detected (for example, accesses to memory above TOCM in cases where the PCI Express interface logic itself might have visibility into TOCM). Such errors do not cause this bit to be set, and are reported using the PCI Express interface error bits (secondary status register). Conditions that cause Bit 13 to be set, include: <ul style="list-style-type: none"> • Device receives a completion on the primary interface (internal bus of Integrated I/O) with Unsupported Request or master abort completion Status. This includes UR status received on the primary side of a PCI Express port on peer-to-peer completions also. • Device accesses to holes in the main memory address region that are detected by Intel QuickPath Interconnect Source Address Decoder. • Other master abort conditions detected on the Integrated I/O internal bus.



(Sheet 2 of 2)

Register: PCISTS Device: 8 Function: 0-3 Offset: 06h			
Bit	Attr	Default	Description
12	RO	0	<p>Received Target Abort</p> <p>This bit is set when a device experiences a completer abort condition on a transaction it mastered on the primary interface (Integrated I/O internal bus). Note that certain errors might be detected right at the PCI Express interface and those transactions might not 'propagate' to the primary interface before the error is detected (for example, accesses to memory above VTCSRBASE). Such errors do not cause this bit to be set, and are reported using the PCI Express interface error bits (secondary status register). Conditions that cause Bit 12 to be set, include:</p> <ul style="list-style-type: none"> • Device receives a completion on the primary interface (internal bus of Integrated I/O) with completer abort completion Status. This includes CA status received on the primary side of a PCI Express port on peer-to-peer completions also. • Accesses to Intel QuickPath InterConnect that return a failed completion status • Other completer abort conditions detected on the Integrated I/O internal bus
11	RO	0	<p>Signaled Target Abort</p> <p>This bit is set when a device signals a completer abort completion status on the primary side (internal bus of Integrated I/O). This condition includes a PCI Express port forwarding a completer abort status received on a completion from the secondary side and passed to the primary side on a peer-to-peer completion.</p>
10:9	RO	0h	<p>DEVSEL# Timing</p> <p>Not applicable to PCI Express. Hardwired to 0.</p>
8	RO	0	<p>Master Data Parity Error</p> <p>This bit is set by a device if the Parity Error Response bit in the PCI Command register is set and it receives a completion with poisoned data from the primary side or if it forwards a packet with data (including MSI writes) to the primary side with poison.</p>
7	RO	0	<p>Fast Back-to-Back</p> <p>Not applicable to PCI Express. Hardwired to 0.</p>
6	RO	0	<i>Reserved</i>
5	RO	0	<p>66-MHz Capable</p> <p>Not applicable to PCI Express. Hardwired to 0.</p>
4	RO	1b(F:0/1/2) 0b (F3)	<p>Capabilities List</p> <p>This bit indicates the presence of a capabilities list structure.</p>
3	RO	0	<p>INTx Status</p> <p>This bit indicates that a legacy INTx interrupt condition is pending internally. This bit has meaning only in the legacy interrupt mode. This bit is always 0 when MSI-X has been selected for DMA interrupts.</p> <p>Note that the setting of the INTx status bit is independent of the INTx enable bit in the PCI command register that is, this bit is set anytime the DMA engine is setup by its driver to generate any interrupt and the condition that triggers the interrupt has occurred, regardless of whether a legacy interrupt message was signaled to the PCH or not. Note that the INTx enable bit has to be set in the PCICMD register for DMA to generate a INTx message to the PCH.</p> <p>This bit is not applicable to PCI Express and DMI ports.</p>
2:0	RV	0h	<i>Reserved</i>

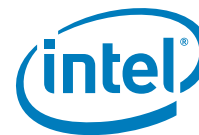

3.4.2.5 RID—Revision Identification Register

This register contains the revision number of the Integrated I/O.

Register: RID Device: 8 Function: 0-3 Offset: 08h			
Bit	Attr	Default	Description
7:4	RO	See description	Minor Revision Steppings which required all masks be regenerated. Refer to the <i>Intel® Core™ i7-800 and i5-700 Desktop Processor Series Specification Update</i> for the value of the Revision ID Register.
3:0	RO	See description	Minor Revision Identification Number (RID) Increment for each steppings which do not require masks to be regenerated. Refer to the <i>Intel® Core™ i7-800 and i5-700 Desktop Processor Series Specification Update</i> for the value of the Revision ID Register.

3.4.2.6 CCR—Class Code Register

This register contains the Class Code for the device.

Register: CCR Device: 8 Function: 0-3 Offset: 09h			
Bit	Attr	Default	Description
23:16	RO	08h	BaseClass Provides the PCI Express base class type. Most common registers will default to 08h. (Base system peripherals.)
15:8	RO	80h	SubClass This field defaults to 80h indicating other system peripherals in PCI v3.0 class code mnemonic).
7:0	RO	00h	Register-Level Programming Interface This field is hardwired to 00h.

3.4.2.7 CLSR—Cacheline Size Register

Register: CLSR Device: 8 Function: 0-2 Offset: 0Ch			
Bit	Attr	Default	Description
7:0	RW	0	Cacheline Size This register is set as RW for compatibility reasons only. Cacheline size for Integrated I/O is always 64B. IIO hardware ignore this setting.



3.4.2.8 HDR—Header Type Register

This register identifies the header layout of the configuration space.

Register: HDR Device: 8 Function: 0-3 Offset: 0Eh			
Bit	Attr	Default	Description
7	RO	1b	Multi-function Device This bit is set to 0 for Single Function Devices and 1 for multi- function devices.
6:0	RO	00h	Configuration Layout This field identifies the format of the configuration header layout. Type1 for all PCI Express* ports and Type 0 for DMI devices.

3.4.2.9 SVID—Subsystem Vendor ID

Register: SVID Device: 8 Function: 0-3 Offset: 2Ch			
Bit	Attr	Default	Description
7:0	RWO	0h	Subsystem Vendor Identification This field is programmed during boot-up to indicate the vendor of the system board. After it has been written once, it becomes read only.

3.4.2.10 SID—Subsystem Device ID

Register: SID Device: 8 Function: 0-3 Offset: 2Eh			
Bit	Attr	Default	Description
7:0	RWO	00h	Subsystem Identification Number Assigned by the subsystem vendor to uniquely identify the subsystem.

3.4.2.11 CAPPTR—Capability Pointer

The CAPPTR provides the offset to the location of the first device capability in the capability list.

Register: CAPPTR Device: 8 Function: 0-3 Offset: 34h			
Bit	Attr	Default	Description
7:0	RO	40h: F 0/1/2 00h: F 3	Capability Pointer Points to the first capability structure for the device.

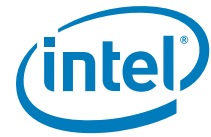

3.4.2.12 INTLIN—Interrupt Line Register

The Interrupt Line register is used to communicate interrupt line routing information between initialization code and the device driver.

Register: INTLIN Device: 8 Function: 0-2 Offset: 3Ch			
Bit	Attr	Default	Description
7:0	RO	00h	Interrupt Line This bit is RW for devices that can generate a legacy INTx message and is needed only for compatibility purposes.

3.4.2.13 INTPIN—Interrupt Pin Register

Indicates what INTx message a device generates. This register has no meaning for Device 8.

Register: INTPIN Device: 8 Function: 0-2 Offset: 3Dh			
Bit	Attr	Default	Description
7:0	RO	00h	Interrupt Pin These bits have no meaning for the device called out in this section and are hard coded to 0.

3.4.3 Common Extended Configuration Space Registers

3.4.3.1 CAPID—PCI Express® Capability List Register

The PCI Express Capability List register enumerates the PCI Express Capability structure in the PCI 3.0 configuration space.

Device: 8 Function: 0, 1, 2 Offset: 40h			
Bit	Attr	Default	Description
7:0	RO	10h	Capability ID Defines the PCI Express capability ID. 10h is defined as a “PCI Express” capability.

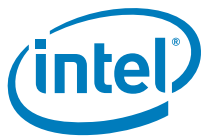

3.4.3.2 NXTPTR—PCI Express® Next Capability List Register

The PCI Express Capability List register enumerates the PCI Express Capability structure in the PCI 3.0 configuration space.

Device: 8 Function: 0, 1, 2 Offset: 41h			
Bit	Attr	Default	Description
7:0	RO	0	Next Ptr This field contains the offset to the next PCI Capability structure.

3.4.3.3 EXPCAP—PCI Express® Capabilities Register

The PCI Express Capabilities register identifies the PCI Express device type and associated capabilities.

Device: 8 Function: 0, 1, 2 Offset: 42h			
Bit	Attr	Default	Description
15:14	RV	0h	<i>Reserved</i>
13:9	RO	00h	Interrupt Message Number This field indicates the interrupt message number that is generated for PM/HP/BW-change events. When there are more than one MSI interrupt Number, this register field is required to contain the offset between the base Message Data and the MSI Message that is generated when the associated status bits in this capability register are set. IIO assigns the first vector for PM/HP/BW-change events and so this field is set to 0.
8	RO	0	Slot Implemented 0 = indicates no slot is connected to this port. 1 = indicates that the PCI Express link associated with the port is connected to a slot. This register bit is of type "write once" and is controlled by BIOS/special initialization firmware.
7:4	RO	1001b	Device/Port Type This field identifies the type of device. It is set to 0100 for all the Express ports and 1001 for the DMA, Perfmon and PCI Express DF* register devices.
3:0	RO	2h	Capability Version This field identifies the version of the PCI Express capability structure. Set to 2h for PCI Express and DMA devices for compliance with the extended base registers.

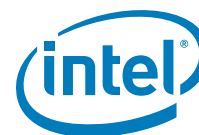

3.4.3.4 DEVCAP—PCI Express® Device Capabilities Register

The PCI Express Device Capabilities register identifies device specific information for the device.

Device: 8 Function: 0, 1, 2 Offset: 44h			
Bit	Attr	Default	Description
31:28	RO	0h	<i>Reserved</i>
27:26	RO	0h	Captured Slot Power Limit Scale Does not apply to root ports or integrated devices.
25:18	RO	00h	Captured Slot Power Limit Value Does not apply to root ports or integrated devices.
17:16	RO	0h	<i>Reserved</i>
15	RO	1	Role Based Error Reporting Integrated I/O is 1.1 compliant and so supports this feature.
14	RO	0	Power Indicator Present on Device Does not apply to root ports or integrated devices.
13	RO	0	Attention Indicator Present Does not apply to root ports or integrated devices.
12	RO	0	Attention Button Present Does not apply to root ports or integrated devices.
11:9	RO	000	Endpoint L1 Acceptable Latency Does not apply to Integrated I/O.
8:6	RO	000	Endpoint L0s Acceptable Latency Does not apply to Integrated I/O.
5	RO	0	Extended Tag Field Supported Integrated I/O devices support only 5-bit tag field.
4:3	RO	0h	Phantom Functions Supported Integrated I/O does not support phantom functions.
2:0	RO	000	Max Payload Size Supported Integrated I/O supports 256B payloads on Express port and 128B on the remainder of the devices.



3.4.3.5 DEVCTRL—PCI Express® Device Control Register

The PCI Express Device Control register controls PCI Express specific capabilities parameters associated with the device.

(Sheet 1 of 2)

Device: 8 Function: 0, 1, 2 Offset: 48h			
Bit	Attr	Default	Description
15	RO	0h	<i>Reserved</i>
14:12	RO	000	Max_Read_Request_Size The PCI Express/DMI ports in Integrated I/O do not generate requests greater than 128B and this field is ignored.
11	RO	0	Enable No Snoop Not applicable to root ports since they never set the 'No Snoop' bit for transactions they originate (not forwarded from peer) to PCI Express. This bit has no impact on forwarding of NoSnoop attribute on peer requests.
10	RO	0	<i>Reserved</i>
9	RO	0	<i>Reserved</i>
8	RO	0h	Extended Tag Field Enable This bit enables the PCI Express port/DMI to use an 8-bit Tag field as a requester.
7:5	RO	000	Max Payload Size This field is set by configuration software for the maximum TLP payload size for the PCI Express port. As a receiver, the Integrated I/O must handle TLPs as large as the set value. As a requester (that is, for requests where Integrated I/O's own RequesterID is used), it must not generate TLPs exceeding the set value. Permissible values that can be programmed are indicated by the Max_Payload_Size_Supported in the Device Capabilities register: 000 = 128B max payload size 001 = 256B max payload size (applies only to standard PCI Express ports and other devices alias to 128B) others = alias to 128B
4	RO	0	Enable Relaxed Ordering Not applicable to root ports since they never set relaxed ordering bit as a requester (this does not include Tx forwarded from peer devices). This bit has no impact on forwarding of relaxed ordering attribute on peer requests.
3	RO	0	Unsupported Request Reporting Enable This bit applies only to the PCI Express/DMI ports. This bit controls the reporting of unsupported requests that Integrated I/O itself detects on requests its receives from a PCI Express/DMI port. 0 = Reporting of unsupported requests is disabled. 1 = Reporting of unsupported requests is enabled. Refer to the latest <i>PCI Express Base Specification</i> for complete details of how this bit is used in conjunction with other bits to UR errors.
2	RO	0	Fatal Error Reporting Enable This bit applies only to the PCI Express/DMI ports. The bit controls the reporting of fatal errors that Integrated I/O detects on the PCI Express/DMI interface. 0 = Reporting of Fatal error detected by device is disabled. 1 = Reporting of Fatal error detected by device is enabled. Refer to the latest <i>PCI Express Base Specification</i> for complete details of how this bit is used in conjunction with other bits to report errors. For the PCI Express/DMI ports, this bit is not used to control the reporting of other internal component uncorrectable fatal errors (at the port unit) in any way.



(Sheet 2 of 2)

Device: 8 Function: 0, 1, 2 Offset: 48h			
Bit	Attr	Default	Description
1	RO	0	<p>Non Fatal Error Reporting Enable</p> <p>This bit applies only to the PCI Express/DMI ports. The bit controls the reporting of non-fatal errors that IIO detects on the PCI Express/DMI interface or any non-fatal errors that PerfMon detect.</p> <p>0 = Reporting of Non Fatal error detected by device is disabled. 1 = Reporting of Non Fatal error detected by device is enabled.</p> <p>Refer to the latest <i>PCI Express Base Specification</i> for complete details of how this bit is used in conjunction with other bits to report errors.</p> <p>For the PCI Express/DMI ports, this bit is not used to control the reporting of other internal component uncorrectable non-fatal errors (at the port unit) in any way.</p>
0	RO	0	<p>Correctable Error Reporting Enable</p> <p>This bit applies only to the PCI Express/DMI ports. The bit controls the reporting of correctable errors that IIO detects on the PCI Express/DMI interface</p> <p>0 = Reporting of link Correctable error detected by the port is disabled. 1 = Reporting of link Correctable error detected by port is enabled.</p> <p>Refer to the latest <i>PCI Express Base Specification</i> for complete details of how this bit is used in conjunction with other bits to report errors.</p> <p>For the PCI Express/DMI ports, this bit is not used to control the reporting of other internal component correctable errors (at the port unit) in any way.</p>



3.4.3.6 DEVSTS—PCI Express® Device Status Register

The PCI Express Device Status register provides information about PCI Express device specific parameters associated with the device.

Device: 8 Function: 0, 1, 2 Offset: 4Ah			
Bit	Attr	Default	Description
15:6	RO	000h	<i>Reserved</i>
5	RO	0h	Transactions Pending 0 = This bit cleared only when all Completions for any outstanding Non-Posted Requests it owns have been received. 1 = Indicates that the DMA device has outstanding Non-Posted Request which it has issued either towards main memory or a peer PCI Express port, which have not been completed.
4	RO	0	<i>Reserved</i>
3	RO	0	Unsupported Request Detected This bit applies only to the root/DMI ports. This bit indicates that the root port detected an Unsupported Request. Errors are logged in this register regardless of whether error reporting is enabled or not in the Device Control Register. 0 = No unsupported request detected by the root port. 1 = Unsupported Request detected at the device/port. These unsupported requests are NP requests inbound that the root port received and it detected them as unsupported requests (for example, address decoding failures that the root port detected on a packet, receiving inbound lock reads, BME bit is clear and so forth). Note that this bit is not set on peer-to-peer completions with UR status that are forwarded by the root port to the PCI Express link.
2	RO	0	Fatal Error Detected This bit applies only to the root/DMI ports. This bit indicates that a fatal (uncorrectable) error is detected by the device. Errors are logged in this register regardless of whether error reporting is enabled or not in the Device Control register. 0 = No Fatal errors detected 1 = Fatal errors detected
1	RO	0	Non Fatal Error Detected This bit applies only to the root/DMI ports. This bit gets set if a non-fatal uncorrectable error is detected by the device. Errors are logged in this register regardless of whether error reporting is enabled or not in the Device Control register. 0 = No non-Fatal Errors detected 1 = Non Fatal errors detected
0	RO	0	Correctable Error Detected This bit applies only to the root/DMI ports. This bit gets set if a correctable error is detected by the device. Errors are logged in this register regardless of whether error reporting is enabled or not in the PCI Express Device Control register. 0 = No correctable errors detected 1 = Correctable errors detected

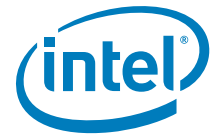

3.4.4 Intel® VT-d, Address Mapping, System Management Registers (Device 8, Function 0)

3.4.4.1 IOMISCCTRL—Integrated I/O Misc Control Register

Register: IOMISCCTRL Device: 8 Function: 0 Offset: 98h			
Bit	Attr	Default	Description
31:14	RV	0	<i>Reserved</i>
13	RW	0	CPUCSR_IB_Abort This bit controls if inbound access to CPUCSR range is enabled. 0 = IB access to CPUCSR range is disabled, that is, allowed. 1 = IB access to CPUCSR range is enabled, that is, disallowed.
12	RW	0	Lock Thawing Mode Mode controls how inbound queues in the south agents (PCIe, DMI) thaw when they are target of a locked read. 0 = Thaw only posted requests 1 = Thaw posted and non-posted requests.
11:10	RW	00	SUBDECEN Indicates the port that provides the subtractive decode path for inbound and outbound decode. 00 = DMI 01 = Reserved 10 = Reserved 11 = Intel QuickPath Interconnect When this points to DMI, all address ranges in the PCI-to-PCI configuration space of the port are ignored for address decode purposes.
9	RV	0	<i>Reserved</i>
8	RW	0	TOCMVALID This bit is set by software after it has initialized the TOCM register with the right value. IIO decoder uses this bit to determine if bits from 32 to TOCM are to be decoded towards privileged CSR space.
7:3	RO	00100	TOCM Indicates the top of Intel QuickPath Interconnect physical addressability limit. 00100 = 2 ³⁶ (default) IIO uses this to abort all inbound transactions that cross this limit.
2	RW	0	EN1K This bit when set, enables 1-K granularity for I/O space decode in each of the virtual PCI-to-PCI bridges corresponding to root ports and DMI ports.
1:0	RV	0	<i>Reserved</i>

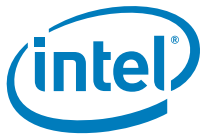

3.4.4.2 I10MISCSS—Integrated I/O MISC Status

This register can be used to read the status of Integrated I/O strapping pins.

Register: I10MISCSS Device: 8 Function: 0 Offset: 9Ch			
Bit	Attr	Default	Description
31:5	RO	0	<i>Reserved</i>
4	RO	1b	<i>Reserved</i>
3	RO	1b	<i>Reserved</i>
2:0	RO	Strap	CFG[2:0] Strap (Port Bifurcation) 111 = x16 (default) 110 = x8x8 101 = <i>Reserved</i> Others = <i>Reserved</i>

3.4.4.3 TSEGCTRL—TSEG Control Register

The location of the TSEG region, size, and enable/disable control.

Register: TSEGCTRL Device: 8 Function: 0 Offset: A8h			
Bit	Attr	Default	Description
31:20	RWO	FE0h	TBA: TSEG Base Address Indicates the base address which is aligned to a 1-MB boundary. Bits [31:20] corresponds to A[31:20] address bits.
19:4	RV	0	<i>Reserved</i>
3:1	RWO	100	TSEG_SIZE: Size of TSEG 000 = 512 KB 001 = 1 MB 010 = 2 MB 011 = 4 MB 100 = 8 MB Others = <i>Reserved</i>
0	RWO	1	TSEG_EN: TSEG Enabling Control 0 = Disabling the TSEG in IIO. 1 = Enabling the TSEG in IIO for IB access check.



3.4.4.4 TOLM—Top of Low Memory

Top of low memory. Note that bottom of low memory is assumed to be 0.

Register: TOLM Device: 8 Function: 0 Offset: D0h			
Bit	Attr	Default	Description
31:26	RWLB	0	TOLM Address Indicates the top of low DRAM memory which is aligned to a 64-MB boundary. A 32-bit transaction that satisfies $0 \leq A[31:26] \leq \text{TOLM}[31:26]$ is a transaction towards main memory.
25:0	RV	0	<i>Reserved</i>

3.4.4.5 TOHM—Top of High Memory

Top of high memory. Note that bottom of high memory is fixed at 4 GB.

Register: TOHM Device: 8 Function: 0 Offset: D4h			
Bit	Attr	Default	Description
63:26	RWLB	0	TOHM Address Indicates the limit of an aligned 64-MB granular region that decodes > 4-GB addresses towards system memory. A 64-bit transaction that satisfies $4\text{G} \leq A[63:26] \leq \text{TOHM}[63:26]$ is a transaction towards main memory. This register is programmed once at boot time and does not change after that, including any quiescent flows.
25:0	RV	0	<i>Reserved</i>

3.4.4.6 NCMEM.BASE—NCMEM Base

Base address of Intel QuickPath Interconnect non-coherent memory.

Register: NCMEM.BASE Device: 8 Function: 0 Offset: DCh			
Bit	Attr	Default	Description
63:26	RW	3F_FFFF_FFFFh	Non-Coherent Memory Base Address Describes the base address of a 64-MB aligned DRAM memory region on Intel QuickPath Interconnect that is non-coherent. Address bits [63:26] of an inbound address if it satisfies $\text{NcMem.Base}[63:26] \leq A[63:26] \leq \text{NcMem.Limit}[63:26]$ is considered to be towards the Intel QuickPath Interconnect non-coherent memory region. It is expected that the range indicated by the Non-coherent memory base and limit registers is a subset of either the low DRAM or high DRAM memory regions as described using the corresponding base and limit registers. This register is programmed once at boot time and does not change after that.
25:0	RV	0	<i>Reserved</i>

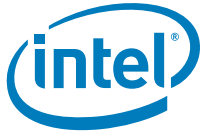

3.4.4.7 NCMEM.LIMIT—NCMEM Limit

Limit address of Intel QuickPath Interconnect non-coherent memory.

Register: NCMEM.LIMIT Device: 8 Function: 0 Offset: E4h			
Bit	Attr	Default	Description
63:26	RW	0	Non-Coherent Memory Limit Address Describes the limit address of a 64-MB aligned DRAM memory region on Intel QuickPath Interconnect that is non-coherent. Address bits [63:26] of an inbound address if it satisfies 'NcMem.Base[63:26] <= A[63:26] <= NcMem.Limit[63:26]' is considered to be towards the non-coherent Intel QuickPath Interconnect memory region. It is expected that the range indicated by the non-coherent memory base and limit registers is a subset of either the low DRAM or high DRAM memory regions as described using the corresponding base and limit registers. This register is programmed once at boot time and does not change after that.
25:0	RV	0	<i>Reserved</i>

3.4.4.8 DEVHIDE1—Device Hide 1 Register

This register provides a method to hide the PCI configuration space of devices inside the Integrated I/O, from the host initiated configuration accesses. This register does not impact JTAG initiated accesses to the corresponding device's configuration space.

When set (for each device), all PCI configuration accesses from Intel QuickPath Interconnect targeting the corresponding device's configuration space inside the Integrated I/O (IIO) are master aborted. When clear, configuration accesses targeting the device's configuration space are allowed.

(Sheet 1 of 3)

Register: DEVHIDE1 Device: 8 Function: 0 Offset: F0h			
Bit	Attr	Default	Description
31:28	RV	0	<i>Reserved</i>
27	RWL	0	Hide_Dev16_Fun1 When set, hide Device #16/Function #1 When set, all PCI configuration accesses from Intel QuickPath Interconnect targeting the corresponding device's configuration space inside IIO are master aborted. When clear, configuration accesses targeting the device's configuration space are allowed. This bit has no effect on smbus and jtag initiated accesses to corresponding device's configuration space. The lock bit is lock1 ("TXTLOCK: TXT Lock Register")

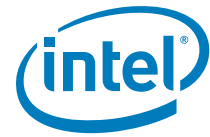

(Sheet 2 of 3)

Register: DEVHIDE1 Device: 8 Function: 0 Offset: F0h			
Bit	Attr	Default	Description
26	RWL	0	Hide_Dev16_Fun0 When set, hide Device #16/Function #0 When set, all PCI configuration accesses from Intel QuickPath Interconnect targeting the corresponding device's configuration space inside IIO are master aborted. When clear, configuration accesses targeting the device's configuration space are allowed. This bit has no effect on smbus and jtag initiated accesses to corresponding device's configuration space. The lock bit is lock1 ("TXTLOCK: TXT Lock Register")
25:20	RV	00h	Reserved
19:12	RV	0	Reserved
12	RWLB	0	Hide_Dev8_Fun3 When set, hide Device 8/Function 3
11:8	RV	0	Reserved
7	RV	0	Reserved
6	RWLB	0	Hide_Dev6 When set, hide Device #6 1. This bit has no impact on any configuration transactions that target the secondary side of a device that is a PCI-to-PCI bridge. 2. This bit has no effect on JTAG initiated accesses to corresponding device's configuration space. 3. This bit has no impact on memory transactions targeting the device or memory transactions forwarded through the device. 4. This bit has no impact on IO transactions forwarded through the device to the PCI Express/DMI link. 5. This bit has no impact on messages forwarded to/through the device (for example, messages forwarded through a PCI-to-PCI bridge to PCI Express link)
5	RWLB	0	Hide_Dev5 When set, hide Device 5 1. This bit has no impact on any configuration transactions that target the secondary side of a device that is a PCI-to-PCI bridge. 2. This bit has no effect on JTAG initiated accesses to corresponding device's configuration space. 3. This bit has no impact on memory transactions targeting the device or memory transactions forwarded through the device. 4. This bit has no impact on IO transactions forwarded through the device to the PCI Express/DMI link. 5. This bit has no impact on messages forwarded to/through the device (for example, messages forwarded through a PCI-to-PCI bridge to PCI Express link)
4	RWL	0	Hide_Dev4 When set, hide Device 4 1. This bit has no impact on any configuration transactions that target the secondary side of the PCI-to-PCI bridge. 2. This bit has no effect on JTAG initiated accesses to corresponding device's configuration space. 3. This bit has no impact on memory transactions forwarded through the device (for example, memory transactions forwarded through the Device#0 p2p bridge, to the PCI Express link) 4. This bit has no impact on IO transactions forwarded through the device to the PCI Express/DMI link. 5. This bit has no impact on messages forwarded to/through the device (for example, messages forwarded through a PCI-to-PCI bridge to PCI Express link)

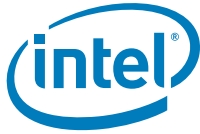

(Sheet 3 of 3)

Register: DEVHIDE1 Device: 8 Function: 0 Offset: F0h			
Bit	Attr	Default	Description
3	RWL	0	Hide_Dev3 When set, hide Device 3 1. This bit has no impact on any configuration transactions that target the secondary side of a device that is a PCI-to-PCI bridge. 2. This bit has no effect on JTAG initiated accesses to corresponding device's configuration space. 3. This bit has no impact on memory transactions targeting the device or memory transactions forwarded through the device. 4. This bit has no impact on IO transactions forwarded through the device to the PCI Express/DMI link. 5. This bit has no impact on messages forwarded to/through the device (for example, messages forwarded through a PCI-to-PCI bridge to PCI Express link)
2:1	RV	0	<i>Reserved</i>
0	RWL	0	Hide_Dev0 When set, hide Device 0 1. This bit has no impact on any configuration transactions that target the secondary side of the PCI-to-PCI bridge 2. This bit has no effect on JTAG initiated accesses to corresponding device configuration space 3. This bit has no impact on memory transactions forwarded through the device (for example, memory transactions forwarded through the Device 0 PCI-to-PCI bridge, to the PCI Express link) 4. This bit has no impact on IO transactions forwarded through the device to the PCI Express/DMI link. 5. This bit has no impact on messages forwarded to/through the device (for example, messages forwarded through a PCI-to-PCI bridge to PCI Express link)

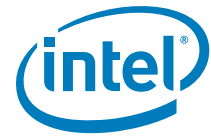

3.4.4.9 DEVHIDE2—Device Hide 2 Register

This register provides a method to hide the PCI configuration space of devices inside IIO, from the host initiated configuration accesses. This register does not impact JTAG initiated accesses to the corresponding device’s configuration space.

When set (for each device), all PCI configuration accesses from Intel QuickPath Interconnect targeting the corresponding device’s configuration space inside the Integrated I/O (IIO) are master aborted. When clear, configuration accesses targeting the device’s configuration space are allowed.

Note: If software hides Function 0 in Device 8, it needs to hide all functions within that device to comply with PCI rules.

Register: DEVHIDE2 Device: 8 Function: 0 Offset: F8h			
Bit	Attr	Default	Description
31:7	RV	0000000h	Reserved
6	RV	0b	Reserved
5	RWLB	0b	Hide_Dev8_Fun2 When set, hide Device 8/Function 2. 1. This bit has no effect on JTAG initiated accesses to corresponding device’s configuration space. 2. This bit has no impact on memory transactions targeting the device.
4	RWLB	0b	Hide_Dev8_Fun1 When set, hide Device 8/Function 1. 1. This bit has no effect on JTAG initiated accesses to corresponding device’s configuration space. 2. This bit has no impact on memory transactions targeting the device.
3	RWLB	0b	Hide_Dev8_Fun0 When set, hide Device 8/Function 0. 1. This bit has no effect on JTAG initiated accesses to corresponding device’s configuration space. 2. This bit has no impact on memory transactions targeting the device. Note: If Dev8_Fun0 is hidden, then other functions within this device should also be hidden to comply with PCI rules.
2:0	RV	0h	Reserved

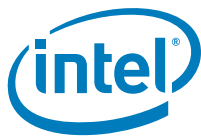

3.4.4.10 IIOBUSNO—IIO Internal Bus Number

Register: IIOBUSNO Device: 8 Function: 0 Offset: 10Ah			
Bit	Attr	Default	Description
15:9	RV	00h	<i>Reserved</i>
8	RW	0b	Valid 0 = The IIO claims PCI configuration access to its internal devices (device/function) defined in Table 3-1, "Functions Handled by the Processor Integrated I/O (IIO)" with ANY Bus number, regardless of bits[7:0] of this register. 1 = The IIO (Integrated I/O) claims PCI configuration access to its internal devices (device/function) defined in Table 3-1, "Functions Handled by the Processor Integrated I/O (IIO)" with the Bus number defined in bits[7:0] of this register only. Since the processor does not support values other than 00 for the bus number, BIOS should set this bit to 1 to prevent the bus number from changing.
7:0	RW	00h	Internal bus number of IIO (Integrated I/O) This field is used to compare against the bus # in the Intel QuickPath Interconnect configuration tx and decide if the access is to the IIO internal devices or if it goes out to a bus hierarchy below the IIO's internal bus. This register is programmed once at boot time and does not change after that. For the processor, the default value of 00h is the only valid setting.

3.4.4.11 LMMIOL.BASE—Local MMIOL Base

Register: LMMIOL.BASE Device: 8 Function: 0 Offset: 10Ch			
Bit	Attr	Default	Description
15:8	RW	00h	Local MMIOL Base Address This field corresponds to A[31:24] of MMIOL base address. An inbound or outbound memory address that satisfies 'local MMIOL base[15:8] ≤ A[31:24] ≤ local MMIOL limit[15:8]' is treated as a local peer-to-peer transaction that does not cross an Intel QuickPath Interconnect link. Setting LMMIOL.BASE greater than LMMIOL.LIMIT disables local MMIOL peer-to-peer. This register is programmed once at boot time and does not change after that.
7:0	RO	0h	<i>Reserved</i>



3.4.4.12 LMMIOL.LIMIT—Local MMIO Limit

Register: LMMIOL.LIMIT Device: 8 Function: 0 Offset: 10Eh			
Bit	Attr	Default	Description
15:8	RW	00h	Local MMIO Limit Address This field corresponds to A[31:24] of MMIO limit. An inbound or outbound memory address that satisfies 'local MMIO base[15:8] ≤ A[31:24] ≤ local MMIO limit[15:8]' is treated as a local peer-to-peer transaction that does not cross an Intel QuickPath Interconnect link. Setting LMMIOL.BASE greater than LMMIOL.LIMIT disables local MMIO peer-to-peer. This register is programmed once at boot time and does not change after that.
7:0	RO	0h	<i>Reserved</i>

3.4.4.13 LMMIOH.BASE—Local MMIOH Base

Register: LMMIOH.BASE Device: 8 Function: 0 Offset: 110h			
Bit	Attr	Default	Description
15:10	RW	00h	Local MMIOH Base Address This field corresponds to A[31:26] of MMIOH base. An inbound or outbound memory address that satisfies 'local MMIOH base upper[31:0]::local MMIOH base[15:10] ≤ A[63:26] ≤ local MMIOH limit upper[31:0]::local MMIOH limit[15:10]' is treated as a local peer-to-peer transaction that does not cross an Intel QuickPath Interconnect link. Setting LMMIOH.BASEU::LMMIOH.BASE greater than LMMIOH.LIMITU::LMMIOH.LIMIT disables local MMIOH peer-to-peer. This register is programmed once at boot time and does not change after that.
9:0	RO	0h	<i>Reserved</i>

3.4.4.14 LMMIOH.LIMIT—Local MMIOH Limit

Register: LMMIOH.LIMIT Device: 8 Function: 0 Offset: 112h			
Bit	Attr	Default	Description
15:10	RW	00h	Local MMIOH Limit Address This field corresponds to A[31:26] of MMIOH limit. An inbound or outbound memory address that satisfies 'local MMIOH base upper[31:0]::local MMIOH base[15:10] ≤ A[63:26] ≤ local MMIOH limit upper[31:0]::local MMIOH limit[15:10]' is treated as a local peer-to-peer transaction that does not cross an Intel QuickPath Interconnect link. Setting LMMIOH.BASEU::LMMIOH.BASE greater than LMMIOH.LIMITU::LMMIOH.LIMIT disables local MMIOH peer-to-peer. This register is programmed once at boot time and does not change after that.
9:0	RO	000h	<i>Reserved</i>

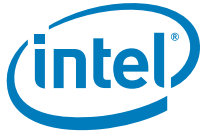

3.4.4.15 LMMIOH.BASEU—Local MMIOH Base Upper

Register: LMMIOH.BASEU Device: 8 Function: 0 Offset: 114h			
Bit	Attr	Default	Description
31:19	RO	0000h	This field corresponds to address A[63:51] of the local MMIOH range and is always 0.
18:0	RW	00000h	Local MMIOH Base Upper Address This field corresponds to A[50:32] of MMIOH base. An inbound or outbound memory address that satisfies 'local MMIOH base upper[31:0]::local MMIOH base[15:10] ≤ A[63:26] ≤ local MMIOH limit upper[31:0]::local MMIOH limit[15:10]' is treated as a local peer-to-peer transaction that does not cross an Intel QuickPath Interconnect link. Setting LMMIOH.BASEU::LMMIOH.BASE greater than LMMIOH.LIMITU::LMMIOH.LIMIT disables local MMIOH peer-to-peer. This register is programmed once at boot time and does not change after that.

3.4.4.16 LMMIOH.LIMITU—Local MMIOH Limit Upper

Register: LMMIOH.LIMITU Device: 8 Function: 0 Offset: 118h			
Bit	Attr	Default	Description
31:19	RO	0000h	This field corresponds to address A[63:51] of the local MMIOH range and is always 0.
18:0	RW	00000h	Local MMIOH Limit Upper Address This field corresponds to A[50:32] of MMIOH limit. An inbound or outbound memory address that satisfies 'local MMIOH base upper[31:0]::local MMIOH base[15:10] ≤ A[63:26] ≤ local MMIOH limit upper[31:0]::local MMIOH limit[15:10]' is treated as local a peer-to-peer transactions that does not cross an Intel QuickPath Interconnect link. Setting LMMIOH.BASEU::LMMIOH.BASE greater than LMMIOH.LIMITU::LMMIOH.LIMIT disables local MMIOH peer-to-peer. This register is programmed once at boot time and does not change after that.

3.4.4.17 LCFGBUS.BASE—Local Configuration Bus Number Base Register

Register: LCFGBUS.BASE Device: 8 Function: 0 Offset: 11Ch			
Bit	Attr	Default	Description
7:0	RW	00h	Local Configuration Bus Number Base This field corresponds to base bus number of bus number range allocated to the hierarchy below the Intel QuickPath Interconnect link. An inbound or outbound configuration tx falls within the local bus number range if 'Local Bus Number Base [7:0] ≤ Bus Number[7:0] ≤ Local Bus Number Limit [7:0]' and such transactions are treated as local peer-to-peer transactions that do not cross an Intel QuickPath Interconnect link. Setting LCFGBUS.BASE greater than LCFGBUS.LIMIT disables local peer-to-peer configuration cycles. This register is programmed once at boot time and does not change after that.

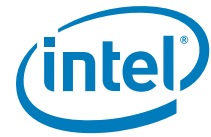

3.4.4.18 LCFGBUS.LIMIT—Local Configuration Bus Number Limit Register

Register: LCFGBUS.LIMIT Device: 8 Function: 0 Offset: 11Dh			
Bit	Attr	Default	Description
7:0	RW	00h	Local Configuration Bus Number Limit This field corresponds to Limit bus number of bus number range allocated to the hierarchy below the Intel QuickPath Interconnect link. An inbound or outbound configuration falls within the local bus number range if 'Local Bus Number Base [7:0] ≤ Bus Number[7:0] ≤ Local Bus Number Limit [7:0]' and such transactions are treated as local peer-to-peer transactions that do not cross an Intel QuickPath Interconnect link. Setting LCFGBUS.BASE greater than LCFGBUS.LIMIT disables local peer-to-peer configuration cycles. This register is programmed once at boot time and does not change after that.

3.4.4.19 GMMIOL.BASE—Global MMIOL Base

Register: GMMIOL.BASE Device: 8 Function: 0 Offset: 124h			
Bit	Attr	Default	Description
15:8	RW	00h	Global MMIOL Base Address This field corresponds to A[31:24] of global MMIOL base. An inbound or outbound memory address that satisfies 'global MMIOL base[15:8] ≤ A[31:24] ≤ global MMIOL limit[15:8]' but is outside of the local MMIOL range is treated as a remote peer memory transaction over Intel QuickPath Interconnect. Setting GMMIOL.BASE greater than GMMIOL.LIMIT disables global MMIOL peer-to-peer. This register is programmed once at boot time and does not change after that.
7:0	RO	00h	<i>Reserved</i>

3.4.4.20 GMMIOL.LIMIT—Global MMIOL Limit

Register: GMMIOL.LIMIT Device: 8 Function: 0 Offset: 126h			
Bit	Attr	Default	Description
15:8	RW	00h	Global MMIOL Limit Address This field corresponds to A[31:24] of global MMIOL limit. An inbound or outbound memory address that satisfies 'global MMIOL base[15:8] ≤ A[31:24] ≤ global MMIOL limit[15:8]' but is outside of the local MMIOL range is treated as a remote peer-to-peer transaction over Intel QuickPath Interconnect link. Setting GMMIOL.BASE greater than GMMIOL.LIMIT disables global MMIOL peer-to-peer. This register is programmed once at boot time and does not change after that.
7:0	RO	00h	<i>Reserved</i>



3.4.4.21 GMMIOH.BASE—Global MMIOH Base

Register: GMMIOH.BASE Device: 8 Function: 0 Offset: 128h			
Bit	Attr	Default	Description
15:10	RW	00h	Global MMIOH Base Address This field corresponds to A[31:26] of global MMIOH base. An inbound or outbound memory address that satisfies 'global MMIOH base upper[31:0]::global MMIOH base[15:10] ≤ A[63:26] ≤ global MMIOH limit upper[31:0]::global MMIOH limit[15:10]' but is outside of the local MMIOH range is treated as a remote peer-to-peer transaction over Intel QuickPath Interconnect link. Setting GMMIOH.BASEU::GMMIOH.BASE greater than GMMIOH.LIMITU::GMMIOH.LIMIT disables global MMIOH peer-to-peer. This register is programmed once at boot time and does not change after that.
9:0	RO	000h	<i>Reserved</i>

3.4.4.22 GMMIOH.LIMIT—Global MMIOH Limit

Register: GMMIOH.LIMIT Device: 8 Function: 0 Offset: 12Ah			
Bit	Attr	Default	Description
15:10	RW	00h	Global MMIOH Limit Address This field corresponds to A[31:26] of global MMIOH limit. An inbound or outbound memory address that satisfies 'global MMIOH base upper[31:0]::global MMIOH base[15:10] ≤ A[63:26] ≤ global MMIOH limit upper[31:0]::global MMIOH limit[15:10]' but is outside of the local MMIOH range is treated as a remote peer-to-peer transaction over Intel QuickPath Interconnect link. Setting GMMIOH.BASEU::GMMIOH.BASE greater than GMMIOH.LIMITU::GMMIOH.LIMIT disables global MMIOH peer-to-peer. This register is programmed once at boot time and does not change after that.
9:0	RO	000h	<i>Reserved</i>

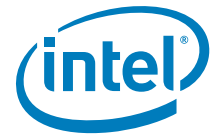

3.4.4.23 GMMIOH.BASEU—Global MMIOH Base Upper

Register: GMMIOH.BASEU Device: 8 Function: 0 Offset: 12Ch			
Bit	Attr	Default	Description
31:19	RO	0h	This field corresponds to address A[63:51] of the global MMIOH range and is always 0.
18:0	RW	0h	Global MMIOH Base Upper Address This field corresponds to A[50:32] of global MMIOH base. An inbound or outbound memory address that satisfies 'global MMIOH base upper[31:0]::global MMIOH base[15:10] ≤ A[63:26] ≤ global MMIOH limit upper[31:0]::global MMIOH limit[15:10]' but is outside of the local MMIOH range is treated as a remote peer-to-peer transaction over Intel QuickPath Interconnect link. Setting GMMIOH.BASEU::GMMIOH.BASE greater than GMMIOH.LIMITU::GMMIOH.LIMIT disables global MMIOH peer-to-peer. This register is programmed once at boot time and does not change after that.

3.4.4.24 GMMIOH.LIMITU—Global MMIOH Limit Upper

Register: GMMIOH.LIMITU Device: 8 Function: 0 Offset: 130h			
Bit	Attr	Default	Description
31:19	RO	0h	This field corresponds to address A[63:51] of the global MMIOH range and is always 0.
18:0	RW	0h	Global MMIOH Limit Upper Address This field corresponds to A[51:32] of global MMIOH limit. An inbound or outbound memory address that satisfies 'global MMIOH base upper[31:0]::global MMIOH base[15:10] ≤ A[63:26] ≤ global MMIOH limit upper[31:0]::global MMIOH limit[15:10]' but is outside of the local MMIOH range is treated as a remote peer-to-peer transaction over Intel QuickPath Interconnect link. Setting GMMIOH.BASEU::GMMIOH.BASE greater than GMMIOH.LIMITU::GMMIOH.LIMIT disables global MMIOH peer-to-peer. This register is programmed once at boot time and does not change after that.

3.4.4.25 GCFGBUS.BASE—Global Configuration Bus Number Base Register

Register: GCFGBUS.BASE Device: 8 Function: 0 Offset: 134h			
Bit	Attr	Default	Description
7:0	RW	0h	Global Configuration Bus Number Base This field corresponds to base bus number of bus number range that spans all IIOs in a partition. An inbound or outbound configuration tx that satisfies 'Global Bus Number Base [7:0] ≤ Bus Number[7:0] ≤ Global Bus Number Limit [7:0]' but is outside of the local bus number range is treated as a remote peer-to-peer transaction over Intel QuickPath Interconnect link.



3.4.4.26 GCFGBUS.LIMIT—Global Configuration Bus Number Limit Register

Register: GCFGBUS.LIMIT Device: 8 Function: 0 Offset: 135h			
Bit	Attr	Default	Description
7:0	RW	FFh	Global Configuration Bus Number Limit This field corresponds to limit bus number of bus number range allocated across all IIOs in the partition. An inbound or outbound configuration that satisfies 'Global Bus Number Base [7:0] ≤ Bus Number[7:0] ≤ Global Bus Number Limit [7:0]' but is outside of the low bus number range is treated as a remote peer-to-peer transaction over Intel QuickPath Interconnect link. This register is programmed once at boot time and does not change after that.

3.4.4.27 MESEGBASE—Intel® Management Engine (Intel® ME) Memory Region Base

The MESEGBASE and MESEGMASK registers are used for protecting Intel® Management Engine (Intel ME) stolen memory from processor accesses.

Register: MESEGBASE Device: 8 Function: 0 Offset: 138h			
Bit	Attr	Default	Description
63:36	RV	0	<i>Reserved</i>
35:19	RWL	1FFFFh	Base address of ME SEG Must be 4-MB aligned. This field is controlled by Bit 10 of MESEGMASK register.
18:0	RV	0	<i>Reserved</i>

3.4.4.28 MESEGMASK—Intel® ME Memory Region Mask

Register: MESEGMASK Device: 8 Function: 0 Offset: 140H			
Bit	Attr	Default	Description
63:36	RV	0	<i>Reserved</i>
35:19	RWL	0	Which bits must match the MESEGBASE in order to be inside the Intel ME memory region
18:12	RV	0	<i>Reserved</i>
11	RWO	0	Enable for Intel ME memory region
10	RWO	0	Lock for Intel ME memory region base/mask. This bit is only cleared upon a reset. MESEGMASK and MESEGBASE cannot be changed once this bit is set.
9:0	RV	0	<i>Reserved</i>

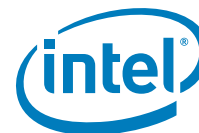

3.4.4.29 VTBAR—Base Address Register for Intel® VT-d Chipset Registers

Register: VTBAR Device: 8 Function: 0 Offset: 180h			
Bit	Attr	Default	Description
31:13	RWL	00000h	Intel VT-d Chipset Base Address This field provides an aligned 8-K base address for IIO registers relating to Intel VT-d. All inbound accesses to this region are completely aborted by the IIO. This is programmed once at boot time and does not change after that. This field may be locked as RO in Intel TXT mode.
12:1	RV	000h	<i>Reserved</i>
0	RWL	0	Intel VT-d Chipset Base Address Enable Enables the VTBAR register. This bit is RO when VTGENCTRL[15]=1 OR may be locked as RO in Intel TXT mode, else this bit is RW.



3.4.4.30 VTGENCTRL—Intel® VT-d General Control Register

Register: VTGENCTRL Device: 8 Function: 0 Offset: 184h			
Bit	Attr	Default	Description
15	RWO	0b	Lock Intel VT-d When this bit is 0, the VTBAR[0] is RWL (where the lock functionality is described in VTBAR register). When this bit is 0, VTBAR[0] is RO.
14:11	RV	0h	<i>Reserved</i>
10:8	RWL	111b	Isoch GPA_LIMIT Represents the guest virtual addressing limit for the Isoch Intel VT-d engine. 000–011 = Reserved 100 = 2^{36} (that is, Bits 35:0) 101 = 2^{37} 110 = 2^{38} 111 = 2^{39} When Intel VT-d translation is enabled on the isoch Intel VT-d engine, all incoming guest addresses from isochronous device, that go beyond the limit specified in this register will be aborted by the IIO and a UR response returned. This register is not used when translation is not enabled. Note that 'translated' and 'pass-through' addresses are in the 'host-addressing' domain and NOT 'guest-addressing' domain and hence GPA_LIMIT checking on those accesses are bypassed and instead HPA_LIMIT checking applies. This field may be locked as RO in Intel TXT mode
7:4	RWL	0h	Isoch/Non-Isoch HPA_LIMIT Represents the host processor addressing limit 0000 = 2^{36} (that is, Bits 35:0) 0001 = 2^{37} (that is, Bits 36:0) ... 1111 = 2^{51} (that is, Bits 50:0) When Intel VT-d translation is enabled on an Intel VT-d engine (isoch or non-isoch), all host addresses (during page walks) that go beyond the limit specified in this register will be aborted by IIO. Note that pass-through accesses carry the host-address directly in the access and are subject to this check as well. This field may be locked as RO in Intel TXT mode
3:0	RWL	8h	Non-Isoch GPA_LIMIT Represents the guest virtual addressing limit for the non-Isoch Intel VT-d engine. 0000 = 2^{40} (that is, Bits 39:0) 0001 = 2^{41} (that is, Bits 40:0) 0111 = 2^{47} 1000 = 2^{48} 1001–1111 = Reserved When Intel VT-d translation is enabled, all incoming guest addresses from PCI Express, associated with the non-isoch Intel VT-d engine, that go beyond the limit specified in this register will be aborted by IIO and a UR response returned. This register is not used when translation is not enabled. Note that 'translated' and 'pass-through' addresses are in the 'host-addressing' domain and NOT 'guest-addressing' domain and hence GPA_LIMIT checking on those accesses are bypassed and instead HPA_LIMIT checking applies. This field may be locked as RO in Intel TXT mode

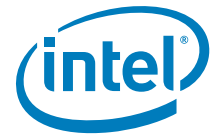

3.4.4.31 VTISOCHCTRL—Intel VT-d Isoch Related Control Register

Register: VTISOCHCTRL Device: 8 Function: 0 Offset: 188h			
Bit	Attr	Default	Description
31:5	RV	0	<i>Reserved</i>
4:2	RWL	0	Number of Isoch cache entries when Isoch Intel VT-d engine is enabled: 000 = 0 entries 001 = 1 entry 010 = 2 entries Others = Reserved
1	RWL	0	2 entries for isochronous Desc This field may be locked as RO in Intel TXT mode
0	RWL	1	Steer isochronous to non-isochronous Intel VT-d engine This field may be locked as RO in Intel TXT mode

3.4.4.32 VTGENCTRL2—Intel VT-d General Control 2 Register

Register: VTGENCTRL2 Device: 8 Function: 0 Offset: 18Ch			
Bit	Attr	Default	Description
31:11	RV	0	<i>Reserved</i>
10:7	RWL	Fh	LRU Timer
6:5	RWL	01	Prefetch Control This field controls which Intel VT-d reads are to be considered for prefetch/snarf/reuse in the Intel QuickPath Interconnect buffers. 00 = Prefetch/snarf/reuse is disabled. 01 = Prefetch/snarf/reuse is enabled for all leaf/non-leaf Intel VT-d page walk reads. Others = Reserved
4	RV	0	<i>Reserved</i>
3	RV	0	<i>Reserved</i>
2	RV	0	<i>Reserved</i>
1	RV	0	<i>Reserved</i>
0	RV	0	<i>Reserved</i>



3.4.4.33 VTSTS—Intel® VT-d Status Register

Register: VTSTS			
Device: 8			
Function: 0			
Offset: 190h			
Bit	Attr	Default	Description
31:2	RV	00000000h	<i>Reserved</i>
1	RW1CS	0	Interrupt Transaction Seen on VC1/VCp
0	RW1CS	0	<i>Reserved</i>

3.4.5 Semaphore and ScratchPad Registers (Dev:8, F:1)

3.4.5.1 SR[0:3]—Scratch Pad Register 0-3 (Sticky)

Register: SR[0:3]			
Device: 8			
Function: 1			
Offset: 07Ch-088h by 4			
Bit	Attr	Default	Description
31:0	RWSLB	0h	Scratch Pad — Sticky Sticky scratch pad registers for firmware utilization.

3.4.5.2 SR[4:7]—Scratch Pad Register 4-7 (Sticky)

Register: SR[4:7]			
Device: 8			
Function: 1			
Offset: 08Ch-098h by 4			
Bit	Attr	Default	Description
31:0	RWSLB	0h	Scratch Pad — Sticky Sticky scratch pad registers for firmware utilization.

3.4.5.3 SR[8:11]—Scratch Pad Register 8-11 (Non-Sticky)

Register: SR[8:11]			
Device: 8			
Function: 1			
Offset: 09Ch-0A8h by 4			
Bit	Attr	Default	Description
31:0	RWLB	0h	Scratch Pad — Non-Sticky Non-sticky scratch pad registers for firmware utilization.

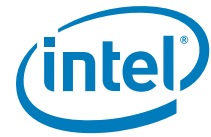

3.4.5.4 SR[12:15]—Scratch Pad Register 12-15 (Non-Sticky)

Register: SR[12:15] Device: 8 Function: 1 Offset: 0ACh-0B8h by 4			
Bit	Attr	Default	Description
31:0	RWLB	0h	Scratch Pad — Non-Sticky Non-sticky scratch pad registers for firmware utilization.

3.4.5.5 SR[16:17]—Scratch Pad Register 16-17 (Non-Sticky)

Register: SR[16:17] Device: 8 Function: 1 Offset: 0BCh-0C0h by 4			
Bit	Attr	Default	Description
31:0	RWLB	0h	Scratch Pad — Non-Sticky Non-sticky scratch pad registers for firmware utilization.

3.4.5.6 SR[18:23]—Scratch Pad Register 18-23 (Non-Sticky)

Register: SR[18:23] Device: 8 Function: 1 Offset: 0C4h-0D8h by 4			
Bit	Attr	Default	Description
31:0	RW	0h	Scratch Pad — Non-Sticky Non-sticky scratch pad registers for firmware utilization.

3.4.5.7 CWR[0:3]—Conditional Write Registers 0-3

Register: CWR[0:3] Device: 8 Function: 1 Offset: 0DCh-0E8h by 4			
Bit	Attr	Default	Description
31:0	RWSLB	0h	Conditional Write These registers are physically mapped to scratch pad registers. A read from CWR[n] reads SR[n]. A write to CWR[n] writes SR[n] if SR[n][0] = 0 before the write, and has no effect otherwise. The registers provide firmware with synchronization variables (semaphores) that are overloaded onto the same physical registers as SR.

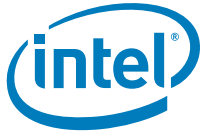

3.4.5.8 CWR[4:7]—Conditional Write Registers 4-7

Register: CWR[4:7] Device: 8 Function: 1 Offset: 0ECh-0F8h by 4			
Bit	Attr	Default	Description
31:0	RWSLB	0h	Conditional Write These registers are physically mapped to scratch pad registers. A read from CWR[n] reads SR[n]. A write to CWR[n] writes SR[n] if SR[n][0] = 0 before the write, and has no effect otherwise. The registers provide firmware with synchronization variables (semaphores) that are overloaded onto the same physical registers as SR.

3.4.5.9 CWR[8:11]—Conditional Write Registers 8-11

Register: CWR[8:11] Device: 8 Function: 1 Offset: 0FCh, 104h -10Ch by 4			
Bit	Attr	Default	Description
31:0	RWLB	0h	Conditional Write These registers are physically mapped to scratch pad registers. A read from CWR[n] reads SR[n]. A write to CWR[n] writes SR[n] if SR[n][0] = 0 before the write, and has no effect otherwise. The registers provide firmware with synchronization variables (semaphores) that are overloaded onto the same physical registers as SR.

3.4.5.10 CWR[12:15]—Conditional Write Registers 12-15

Register: CWR[12:15] Device: 8 Function: 1 Offset: 110h-11Ch by 4			
Bit	Attr	Default	Description
31:0	RWLB	0h	Conditional Write These registers are physically mapped to scratch pad registers. A read from CWR[n] reads SR[n]. A write to CWR[n] writes SR[n] if SR[n][0] = 0 before the write, and has no effect otherwise. The registers provide firmware with synchronization variables (semaphores) that are overloaded onto the same physical registers as SR.

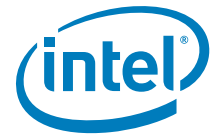

3.4.5.11 CWR[16:17]—Conditional Write Registers 16-17

Register: CWR[16:17] Device: 8 Function: 1 Offset: 18h-124h by 4			
Bit	Attr	Default	Description
31:0	RWLB	0h	Conditional Write These registers are physically mapped to scratch pad registers. A read from CWR[n] reads SR[n]. A write to CWR[n] writes SR[n] if SR[n][0] = 0 before the write, and has no effect otherwise. The registers provide firmware with synchronization variables (semaphores) that are overloaded onto the same physical registers as SR.

3.4.5.12 CWR[18:23]—Conditional Write Registers 18-23

Register: CWR[18:23] Device: 8 Function: 1 Offset: 128h-13Ch by 4			
Bit	Attr	Default	Description
31:0	RW	0h	Conditional Write These registers are physically mapped to scratch pad registers. A read from CWR[n] reads SR[n]. A write to CWR[n] writes SR[n] if SR[n][0] = 0 before the write, and has no effect otherwise. The registers provide firmware with synchronization variables (semaphores) that are overloaded onto the same physical registers as SR.

3.4.5.13 IR[0:3]—Increment Registers 0-3

Register: IR[0:3] Device: 8 Function: 1 Offset: 140h-14Ch by 4			
Bit	Attr	Default	Description
31:0	RWSLB	0h	Increment These registers are physically mapped to scratch pad registers. A read from IR[n] reads SR[n] and then increments SR[n]. A write to IR[n] increments SR[n] while the write data is unused. Increments within SR[n] for reads and writes roll over to zero. The read or write and the increment side effect are atomic with respect to other accesses. The registers provide firmware with synchronization variables (semaphores) that are overloaded onto the same physical registers as SR.



3.4.5.14 IR[4:7]—Increment Registers 4-7

Register: IR[4:7] Device: 8 Function: 1 Offset: 150h-15Ch by 4			
Bit	Attr	Default	Description
31:0	RWSLB	0h	Increment These registers are physically mapped to scratch pad registers. A read from IR[n] reads SR[n] and then increments SR[n]. A write to IR[n] increments SR[n] while the write data is unused. Increments within SR[n] for reads and writes roll over to zero. The read or write and the increment side effect are atomic with respect to other accesses. The registers provide firmware with synchronization variables (semaphores) that are overloaded onto the same physical registers as SR.

3.4.5.15 IR[8:11]—Increment Registers 8-11

Register: IR[8:11] Device: 8 Function: 1 Offset: 160h-16Ch by 4			
Bit	Attr	Default	Description
31:0	RWLB	0h	Increment These registers are physically mapped to scratch pad registers. A read from IR[n] reads SR[n] and then increments SR[n]. A write to IR[n] increments SR[n] while the write data is unused. Increments within SR[n] for reads and writes roll over to zero. The read or write and the increment side effect are atomic with respect to other accesses. The registers provide firmware with synchronization variables (semaphores) that are overloaded onto the same physical registers as SR.

3.4.5.16 IR[12:15]—Increment Registers 12-15

Register: IR[12:15] Device: 8 Function: 1 Offset: 170h-17Ch by 4			
Bit	Attr	Default	Description
31:0	RWLB	0h	Increment These registers are physically mapped to scratch pad registers. A read from IR[n] reads SR[n] and then increments SR[n]. A write to IR[n] increments SR[n] while the write data is unused. Increments within SR[n] for reads and writes roll over to zero. The read or write and the increment side effect are atomic with respect to other accesses. The registers provide firmware with synchronization variables (semaphores) that are overloaded onto the same physical registers as SR.

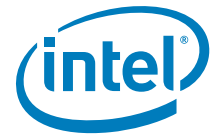

3.4.5.17 IR[16:17]—Increment Registers 16-17

Register: IR[16:17] Device: 8 Function: 1 Offset: 180h-184h by 4			
Bit	Attr	Default	Description
31:0	RWLB	0h	Increment These registers are physically mapped to scratch pad registers. A read from IR[n] reads SR[n] and then increments SR[n]. A write to IR[n] increments SR[n] while the write data is unused. Increments within SR[n] for reads and writes roll over to zero. The read or write and the increment side effect are atomic with respect to other accesses. The registers provide firmware with synchronization variables (semaphores) that are overloaded onto the same physical registers as SR.

3.4.5.18 IR[18:23]—Increment Registers 18-23

Register: IR[18:23] Device: 8 Function: 1 Offset: 188h-19Ch by 4			
Bit	Attr	Default	Description
31:0	RW	0h	Increment These registers are physically mapped to scratch pad registers. A read from IR[n] reads SR[n] and then increments SR[n]. A write to IR[n] increments SR[n] while the write data is unused. Increments within SR[n] for reads and writes roll over to zero. The read or write and the increment side effect are atomic with respect to other accesses. The registers provide firmware with synchronization variables (semaphores) that are overloaded onto the same physical registers as SR.



3.4.6 System Control/Status Registers (Device 8, Function 2)

3.4.6.1 SYSMAP—System Error Event Map Register

This register maps the error severity detected by the IIO to one of the system events.

Register: SYSMAP Device: 8 Function: 2 Offset: 09Ch			
Bit	Attr	Default	Description
31:7	RV	0	<i>Reserved</i>
6:4	RWS	010	Severity 1 Error Map 010 = Generate NMI 001 = Generate SMI 000 = No Inband Message
3	RV	0	<i>Reserved</i>
2:0	RWS	010	Severity 0 Error Map 010 = Generate NMI 001 = Generate SMI 000 = No Inband Message

3.4.6.2 GENMCA—Generate MCA

This register is used to generate an Intel® Scalable Memory Interconnect (Intel SMI) interrupt to the processor by firmware.

Register: GENMCA Device: 8 Function: 2 Offset: 0C4h			
Bit	Attr	Default	Description
31:1	RO	0	<i>Reserved</i>
0	RWS	0	Generate Intel SMI When this bit is set and transition from 0 to 1, Integrated I/O dispatches a MCA interrupt defined in the error MCA configuration register to the processor. This bit is cleared by hardware when Integrated I/O has dispatched MCA to the Intel QuickPath Interconnect link. This bit should never be set since the processor does not support MCA

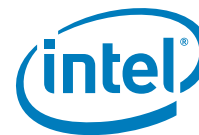

3.4.6.3 SYRE—System Reset

This register controls IIO (Integrated I/O) Reset behavior. Any resets produced by a write to this register must be delayed until the configuration write is completed on the initiating interface (PCI Express, DMI, JTAG).

There is no “SOFT RESET” bit in this register. That function is invoked through the DMI interface. There are no Intel QuickPath Interconnect PCI Express gear ratio definitions in this register. The Intel QuickPath Interconnect frequencies are specified in the FREQ register. The PCI Express frequencies are automatically negotiated in-band.

Register: SYRE Device: 8 Function: 2 Offset: 0CCh			
Bit	Attr	Default	Description
31:17	RV	0	Reserved
16	RV	0	Reserved
15	RV	0	Reserved
14	RV	0	Reserved
13:12	RV	0	Reserved
11	RW	0	RSTMSK 0 = The Integrated I/O will perform the appropriate internal handshakes on RSTIN# signal transitions to progress through the hard reset. 1 = Integrated I/O ignores RST_N, unaffected by the RST_N assertion.
10	RW	0	CPURESET 1 = IIO (Integrated I/O) asserts internal reset. The IIO clears this bit when the CPURESET timer elapses.
9:1	RV	0	Reserved
0	RV	0	Reserved

3.4.7 Miscellaneous Registers (Dev:8, F:3)

3.4.7.1 IIOSLPSTS_L—IIO Sleep Status Low Register

Register: IIOSLPSTS_L Device: 8 Function: 3 Offset: 64h			
Bit	Attr	Default	Description
31:0	ROS	0h	SLPDUR_L: Sleep Duration Low This is the lower 32 bits of the IIOSLPSTS register field that indicates the number of clocks that the Integrated I/O (IIO) has been put to sleep. The IIO will clear this register on entry into sleep state and will increment it for every clock that the IIO is asleep. This combined with IIOSLPSTS_H provides 2^44 clocks worth of monitoring, or approximately 2^44*(1/133 MHz) = 131941s = 36.65 hours (maximum).



3.4.7.2 IIOSLPSTS_H—IIO Sleep Status High Register

Register: IIOSLPSTS_H Device: 8 Function: 3 Offset: 68h			
Bit	Attr	Default	Description
31:12	RV	000h	<i>Reserved</i>
11:0	ROS	0h	SLPDUR_H: Sleep Duration High This is the upper 12 bits of the IIOSLPSTS register field that indicates the number of clocks that the IIO has been put to sleep. The IIO will clear this register on entry into sleep state and will increments it for every clock that the IIO is asleep. This combined with IIOSLPSTS_L provides 2^{44} clocks worth of monitoring, or approximately $2^{44} * (1/133 \text{ MHz}) = 131941s = 36.65 \text{ hours}$ (maximum).

3.4.7.3 PMUSTATE—Power Management State Register

Register: PMUSTATE Device: 8 Function: 3 Offset: D8h			
Bit	Attr	Default	Description
15	RV	00h	<i>Reserved</i>
14	ROS	0h	When set, this bit indicates that Intel QuickPath Interconnect has transitioned to L1.
13	ROS	0h	When set, this bit indicates that the IIO has sent the DMI translated Req->C7 message to the PCH.
12	ROS	0h	When set, this bit indicates that the IIO has sent the DMI translated Req>C6 message to the PCH.
11	ROS	0h	When set, this bit indicates that the IIO has sent the DMI translated Req->C3 message to the PCH.
10	ROS	0h	When set, this bit indicates that the PCH has acknowledged that it is in C7
9	ROS	0h	When set, this bit indicates that the PCH has acknowledged that it is in C6
8	ROS	0h	Indicates that the PCH has acknowledged that it is in C3
7:2	RV	00h	<i>Reserved</i>
1	ROS	0h	Set when the IIO (Integrated I/O) detects a Req C0 message on Intel QuickPath Interconnect. Can remain set until the next Req(C3/6/7) message
0	ROS	0h	Indicates that the PCH has acknowledged the ReqC0 message by returning the InC0.Ack message on DMI

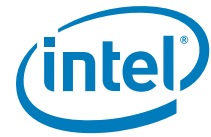

3.4.7.4 CTSTS—Throttling Status Register

Register: CTSTS Device: 8 Function: 3 Offset: F4h			
Bit	Attr	Default	Description
7:2	RV	00h	Reserved
1	RW1CS	0	Integrated I/O Throttling Event This bit is asserted when a high temperature situation is signalled from the processor uncore logic, and reset when de-asserted.
0	RV	0	Reserved

3.4.7.5 CTCTRL—Throttling Control Register

Register: CTCTRL Device: 8 Function: 3 Offset: F7h			
Bit	Attr	Default	Description
7:4	RV	00h	Reserved
3	RW	1h	When set, this bit enables Force L0s on Tx links on PCI Express when an Integrated I/O (IIO) throttling event is signalled. If not set, this feature is de-featured.
2	RW	1h	When set, throttling of Integrated I/O Intel QuickPath Interconnect occurs, when an Integrated I/O (IIO) throttling event is signalled. If not set, this feature is de-featured.
1	RV	0h	Reserved
0	RV	0	Reserved

3.5 Intel® VT-d Memory Mapped Registers

Intel VT-d registers are all addressed using aligned DWord or aligned QWord accesses. Any combination of bits is allowed within a DWord or QWord access. The Intel VT-d remap engine registers corresponding to the non-Isynchronous port represented by Device 0, occupy the first 4 K of offset starting from the base address defined by VTBAR register. The Intel VT-d Isynchronous remap engine registers occupies the second 4 K of offset starting from the base address.

Figure 3-2. Base Address of Intel® VT-d Remap Engines

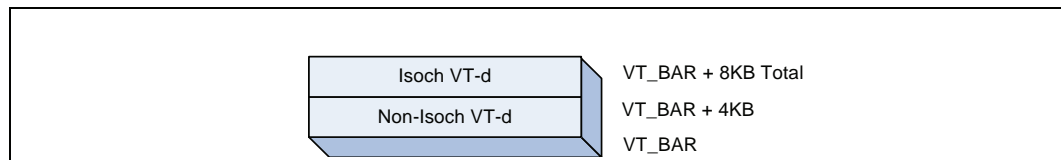

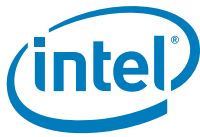

3.5.1 Intel® VT-d Configuration Register Space (MMIO)

Table 3-13. Intel® VT-d Memory Mapped Registers — 00h–FFh, 1000h–10FFh

VER_REG	00h	INV_QUEUE_HEAD_REG	80h
	04h		84h
CAP_REG	08h	INV_QUEUE_TAIL_REG	88h
	0Ch		8Ch
EXTCAP_REG	10h	INV_QUEUE_ADD_REG	90h
	14h		94h
GLBCMD_REG	18h		98h
GLBSTS_REG	1Ch	INV_COMP_STATUS_REG	9Ch
ROOTENTRYADDR_REG	20h	INV_COMP_EVT_CTL_REG	A0h
	24h	INV_COMP_EVT_DATA_REG	A4h
CTXCMD_REG	28h	INV_COMP_EVT_ADDR_REG	A8h
	2Ch	INV_COMP_EVT_UPRADDR_REG	ACH
	30h		B0h
FLTSTS_REG	34h		B4h
FLTEVTCTRL_REG	38h	INTR_REMAP_TABLE_BASE_REG	B8h
FLTEVTDATA_REG	3Ch		BCh
FLTEVTADDR_REG	40h		C0h
FLTEVTUPRADDR_REG	44h		C4h
	48h		C8h
	4Ch		CCh
	50h		D0h
	54h		D4h
	58h		D8h
	5Ch		DCh
	60h		E0h
PMEN_REG	64h		E4h
PROT_LOW_BASE_REG	68h		E8h
PROT_LOW_MEM_LIMIT_REG	6Ch		ECh
PROT_HIGH_MEM_BASE_REG	70h		F0h
	74h		F4h
PROT_HIGH_MEM_LIMIT_REG	78h		F8h
	7Ch		FCh



Table 3-14. Intel® VT-d Memory Mapped Registers — 100h–1FFh, 1100h–11FFh

FLTREC0	100h		180h
	104h		184h
	108h		188h
	10Ch		18Ch
FLTREC1	110h		190h
	114h		194h
	118h		198h
	11Ch		19Ch
FLTREC2	120h		1A0h
	124h		1A4h
	128h		1A8h
	12Ch		1ACh
FLTREC3	130h		1B0h
	134h		1B4h
	138h		1B8h
	13Ch		1BCh
FLTREC4	140h		1C0h
	144h		1C4h
	148h		1C8h
	14Ch		1CCh
FLTREC5	150h		1D0h
	154h		1D4h
	158h		1D8h
	15Ch		1DCh
FLTREC6	160h		1E0h
	164h		1E4h
	168h		1E8h
	16Ch		1ECh
FLTREC7	170h	1F0h	
	174h	1F4h	
	178h	1F8h	
	17Ch	1FCh	



INVADDRREG	200h		280h
	204h		284h
IOTLBINV	208h		288h
	20Ch		28Ch
	210h		290h
	214h		294h
	218h		298h
	21Ch		29Ch
	220h		2A0h
	224h		2A4h
	228h		2A8h
	22Ch		2ACh
	230h		2B0h
	234h		2B4h
	238h		2B8h
	23Ch		2BCh
	240h		2C0h
	244h		2C4h
	248h		2C8h
	24Ch		2CCh
	250h		2D0h
	254h		2D4h
	258h		2D8h
	25Ch		2DCh
	260h		2E0h
	264h		2E4h
	268h		2E8h
	26Ch		2ECh
	270h	2F0h	
	274h	2F4h	
278h	2F8h		
27Ch	2FCh		



3.5.2 Register Description

In the following sections, Intel VT-d registers [0] correspond to the non-isochronous Intel VT-d remap engine and registers [1] correspond to the Isochronous Intel VT-d remap engine.

3.5.2.1 VTD_VERSION[0:1]—Version Number Register

Register: VTD_VERSION[0:1] Addr: MMIO BAR: VTBAR Offset: 00h, 1000h			
Bit	Attr	Default	Description
31:8	RV	0h	<i>Reserved</i>
7:4	RO	1h	Major Revision
3:0	RO	0h	Minor Revision



3.5.2.2 VTD_CAP[0:1]—Intel® VT-d Chipset Capabilities Register

(Sheet 1 of 2)

Register: VTD_CAP[0:1] Addr: MMIO BAR: VTBAR Offset: 08h, 1008h			
Bit	Attr	Default	Description
63:56	RV	0	<i>Reserved</i>
55:54	RO	11b	<i>Reserved</i>
53:48	RO	09h	Max Address Mask Value (MAMV) IIO supports MAMV value of 9h.
47:40	RO	Off: def 7h (non- Isoch) 0h (Isoch)	Number of Fault Recording Registers IIO supports 8 fault recording registers for non-isochronous Intel VT-d engine, and 1 fault recording register for isochronous Intel VT-d engine.
39	RO	1	Page Selective Invalidation Supported in IIO (Integrated I/O)
38	RV	0	<i>Reserved</i>
37:34	RO	0h	<i>Reserved</i>
33:24	RO	10h	Fault Recording Register Offset Fault registers are at offset 100h
23	RWO	Off: def 08h: 0 else: 1	Isoch This bit is set to 1 for isochronous Intel VT-d engine and 0 for the non-isochronous engine.
22	RV	1	<i>Reserved</i>
21:16	RO	Off: def 08h: 2Fh else: 26h	MGAW For non-isochronous Intel VT-d engine, this field is set based on the setting of the Non-Isoch GPA_LIMIT field in the VTGENCTRL register. Similarly for isoch Intel VT-d engine, this field is set by the Isoch GPA_LIMIT field of the VTGENCTRL register.
15	RV	0h	<i>Reserved</i>
14:13	RO	0h	<i>Reserved</i>
12:8	RO	Off: def 08h: 4h else: 2h	SAGAW IIO supports 3 level walks on the Isochronous Intel VT-d engine and 4 level walks on the non-Isochronous Intel VT-d engine.
7	RO	0	TCM IIO does not cache invalid pages.
6	RO	1	PHMR Support IIO supports protected high memory range.
5	RO	1	PLMR Support IIO supports protected low memory range.
4	RO	0	<i>Reserved</i>
3	RO	0	Advanced Fault Logging IIO does not support advanced fault logging.
2:0	RO	010b	Number of Domains Supported IIO supports 256 domains with 8-bit domain ID

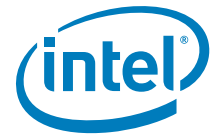

3.5.2.3 EXT_VTD_CAP[0:1]—Extended Intel® VT-d Capability Register

Register: EXT_VTD_CAP[0:1] Addr: MMIO BAR: VTBAR Offset: 10h, 1010h			
Bit	Attr	Default	Description
63:24	RV	0	<i>Reserved</i>
23:20	RO	Fh	Max Handle Mask Value IIO supports all 16 bits of handle being masked. Note: IIO always performs global interrupt entry invalidation on any interrupt cache invalidation command and h/w never really looks at the mask value.
19:18	RV	0	<i>Reserved</i>
17:8	RO	20h	Invalidation Unit Offset IIO has the invalidation registers at offset 200h
7	RWO	0 (offset 1010h) 1 (offset 10h)	0 = Hardware does not support 1-setting of the SNP field in the page-table entries. 1 = Hardware supports the 1-setting of the SNP field in the page-table entries. IIO supports snoop override only for the non-isochronous Intel VT-d engine.
6	RV	1	<i>Reserved</i>
5	RO	1	Caching hints IIO supports caching hints
4	RO	0	<i>Reserved</i>
3	RWO	1	Interrupt Remapping Support IIO supports this
2	RV	0 (offset 1010h) 1 (offset 10h)	<i>Reserved</i>
1	RWO	1	Queued Invalidation Support IIO supports this.
0	RWO	0	Coherency Support BIOS can write to this bit to indicate to hardware to either snoop or not-snoop the DMA/Interrupt table structures in memory (root/context/pd/pt/irt). Note that this bit is expected to be always set to 0 for the Isochronous Intel VT-d engine.

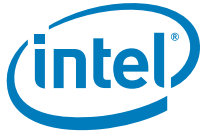

3.5.2.4 GLBCMD[0:1]—Global Command Register

Bit	Attr	Default	Description
Register: GLBCMD[0:1] Addr: MMIO BAR: VTBAR Offset: 18h, 1018h			
31	RV	0	Reserved
30	RW	0	Set Root Table Pointer Software sets this field to set/update the root-entry table pointer used by hardware. The root-entry table pointer is specified through the Root-entry Table Address register. Hardware reports the status of the root table pointer set operation through the RTPS field in the Global Status register. Clearing this bit has no effect.
29	RO	0	Reserved (N/A to IIO)
28	RO	0	Reserved (N/A to IIO)
27	RO	0	Reserved (N/A to IIO)
26	RW	0	Queued Invalidation Enable Software writes to this field to enable queued invalidations. 0 = Disable queued invalidations. In this case, invalidations must be performed through the Context Command and IOTLB Invalidation registers. 1 = Enable use of queued invalidations. Once enabled, all invalidations must be submitted through the invalidation queue and the invalidation registers cannot be used without going through an IIO Reset. The invalidation queue address register must be initialized before enabling queued invalidations. Also software must make sure that all invalidations submitted prior using the register interface are all completed before enabling the queued invalidation interface.
25	RW	0	Interrupt Remapping Enable: 0 = Disable Interrupt Remapping Hardware 1 = Enable Interrupt Remapping Hardware Hardware reports the status of the interrupt-remap enable operation through the IRES field in the Global Status register. Before enabling (or re-enabling) Interrupt-remapping hardware through this field, software must: <ul style="list-style-type: none"> • Setup the interrupt-remapping structures in memory • Set the Interrupt Remap table pointer in hardware (through SIRTP field). • Perform global invalidation of IOTLB
24	RV	0	Reserved
23	RV	0	Reserved
22:0	RV	0	Reserved

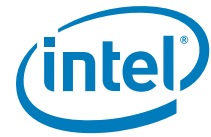

3.5.2.5 GLBSTS[0:1]—Global Status Register

(Sheet 1 of 2)

Register: GLBSTS[0:1] Addr: MMIO BAR: VTBAR Offset: 1Ch, 101Ch			
Bit	Attr	Default	Description
31	RO	0	Translation Enable Status When set, this bit indicates that translation hardware is enabled and when clear indicates the translation hardware is not enabled.
30	RO	0	Set Root Table Pointer Status This field indicates the status of the root- table pointer in hardware.
29	RO	0	<i>Reserved (N/A to IIO)</i>
28	RO	0	<i>Reserved (N/A to IIO)</i>
27	RO	0	<i>Reserved (N/A to IIO)</i>
26	RO	0	Queued Invalidation Interface Status IIO sets this bit once it has completed the software command to enable the queued invalidation interface. Till then this bit is 0.
25	RO	0	Interrupt Remapping Enable Status IIO sets this bit once it has completed the software command to enable the interrupt remapping interface. Till then this bit is 0.
24	RO	0	Interrupt Remapping Table Pointer Status This field indicates the status of the interrupt remapping table pointer in hardware. This field is cleared by hardware when software sets the SIRTTP field in the Global Command register. This field is set by hardware when hardware completes the set interrupt remap table pointer operation using the value provided in the Interrupt Remapping Table Address register.
23:0	RV	000000h	<i>Reserved</i>

3.5.2.6 ROOTENTRYADD[0:1]—Root Entry Table Address Register

Register: ROOTENTRYADD[0:1] Addr: MMIO BAR: VTBAR Offset: 20h, 1020h			
Bit	Attr	Default	Description
63:12	RW	0	Root Entry Table Base Address 4-K aligned base address for the root entry table. Processor does not utilize bits 63:36 and checks for them to be 0. Software specifies the base address of the root-entry table through this register, and enables it in hardware through the <i>SIRTTP</i> field in the <i>Global Command</i> register. Reads of this register returns value that was last programmed to it.
11:0	RV	0	<i>Reserved</i>

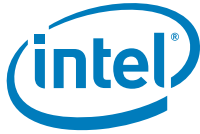

3.5.2.7 CTXCMD[0:1]—Context Command Register

Register: CTXCMD[0:1] Addr: MMIO BAR: VTBAR Offset: 28h, 1028h			
Bit	Attr	Default	Description
63	RW	0	Invalidate Context Entry Cache (ICC) Software requests invalidation of context-cache by setting this field. Software must also set the requested invalidation granularity by programming the CIRG field. Software must read back and check the ICC field to be clear to confirm the invalidation is complete. Software must not update this register when this field is set. Hardware clears the ICC field to indicate the invalidation request is complete. Hardware also indicates the granularity at which the invalidation operation was performed through the CAIG field. Software must not submit another invalidation request through this register while the ICC field is set. Since information from the context-cache may be used by hardware to tag IOTLB entries, software must perform domain-selective (or global) invalidation of IOTLB after the context cache invalidation has completed.
62:61	RW	0	Context Invalidation Request Granularity (CIRG) When requesting hardware to invalidate the context-entry cache (by setting the ICC field), software writes the requested invalidation granularity through this field. Following are the encoding for the 2-bit CIRG field. 00 = Reserved 01 = Global Invalidation request. IIO supports this. 10 = Domain-selective invalidation request. The target domain-ID must be specified in the DID field. IIO supports this. 11 = Device-selective invalidation request. The target SID must be specified in the SID field, and the domain-ID (programmed in the context-entry for this device) must be provided in the DID field. IIO aliases the h/w behavior for this command to the 'Domain-selective invalidation request'. Hardware indicates completion of the invalidation request by clearing the ICC field. At this time, hardware also indicates the granularity at which the actual invalidation was performed through the CAIG field.
60:59	RO	0	Context Actual Invalidation Granularity (CAIG) Hardware reports the granularity at which an invalidation request was processed through the CAIG field at the time of reporting invalidation completion (by clearing the ICC field). The following are the encoding for the 2-bit CAIG field. 00 = Reserved. This is the value on reset. 01 = Global Invalidation performed. IIO sets this in response to a global invalidation request. 10 = Domain-selective invalidation performed using the domain-ID that was specified by software in the DID field. IIO set this in response to a domain-selective or device-selective invalidation request. 11 = Device-selective invalidation. IIO never sets this encoding.
58:34	RV	0000000h	<i>Reserved</i>
33:32	RW	00b	Function Mask Since IIO does not perform any device selective invalidation, this field is a don't care.
31:16	RW	0000h	Source ID IIO ignores this field. (Used when performing device selective context cache invalidation)
15:0	RW	0000h	Domain ID Indicates the ID of the domain whose context-entries needs to be selectively invalidated. S/W needs to program this for both domain and device selective invalidates. IIO ignores Bits 15:8 since it supports only a 8-bit Domain ID.

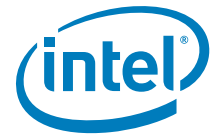

3.5.2.8 FLTSTS[0:1]—Fault Status Register

Register: FLTSTS[0:1] Addr: MMIO BAR: VTBAR Offset: 34h, 1034h			
Bit	Attr	Default	Description
31:16	RV	0	<i>Reserved</i>
15:8	ROS	0	Fault Record Index This field is valid only when the Primary Fault Pending field is set. This field indicates the index (from base) of the fault recording register to which the first pending fault was recorded when the Primary Fault pending field was set by hardware.
7	RV	0	<i>Reserved</i>
6	RW1CS	0	Invalidation Time-out Error (ITE) Hardware detected a Device-IOTLB invalidation completion time-out. At this time, a fault event may be generated based on the programming of the Fault Event Control register.
5	RW1CS	0	Invalidation Completion Error Hardware received an unexpected or invalid Device-IOTLB invalidation completion. At this time, a fault event is generated based on the programming of the Fault Event Control register.
4	RW1CS	0	Invalidation Queue Error (IQE) Hardware detected an error associated with the invalidation queue. For example, hardware detected an erroneous or un-supported Invalidation Descriptor in the Invalidation Queue. At this time, a fault event is generated based on the programming of the Fault Event Control register.
3:2	RV	0	<i>Reserved</i>
1	ROS	0	Primary Pending Fault (PPF) This field indicates if there are one or more pending faults logged in the fault recording registers. 0 = No pending faults in any of the fault recording registers 1 = One or more fault recording registers has pending faults. The fault recording index field is updated by hardware whenever this field is set by hardware. Also, depending on the programming of fault event control register, a fault event is generated when hardware sets this field.
0	RW1CS	0	Primary Fault Overflow Hardware sets this bit to indicate overflow of fault recording registers



3.5.2.9 FLTEVTCTRL[0:1]—Fault Event Control Register

Register: FLTEVTCTRL[0:1] Addr: MMIO BAR: VTBAR Offset: 38h, 1038h			
Bit	Attr	Default	Description
31	RW	1	Interrupt Message Mask (IMM) 0 = Software has cleared this bit to indicate interrupt service is available. When a faulting condition is detected, hardware may issue a interrupt request (using the fault event data and fault event address register values) depending on the state of the interrupt mask and interrupt pending bits. 1 = Hardware is prohibited from issuing interrupt message requests.
30	RO	0	Interrupt Pending (IP) Hardware sets the IP field whenever it detects an interrupt condition. Interrupt condition is defined as when an interrupt condition occurs when hardware records a fault through one of the Fault Recording registers and sets the PPF field in Fault Status register. <ul style="list-style-type: none"> Hardware detected error associated with the Invalidation Queue, setting the IQE field in the Fault Status register. Hardware detected invalidation completion time-out error, setting the ITE field in the Fault Status register. If any of the above status fields in the Fault Status register was already set at the time of setting any of these fields, it is not treated as a new interrupt condition. The IP field is kept set by hardware while the interrupt message is held pending. The interrupt message could be held pending due to interrupt mask (IM field) being set, or due to other transient hardware conditions. The IP field is cleared by hardware as soon as the interrupt message pending condition is serviced. This could be due to either: <ol style="list-style-type: none"> Hardware issuing the interrupt message due to either change in the transient hardware condition that caused interrupt message to be held pending or due to software clearing the IM (Interrupt Mask) field in Section 3.5.2.22. Software servicing all the pending interrupt status fields in the Fault Status register. <ul style="list-style-type: none"> PPF field is cleared by hardware when it detects all the Fault Recording registers have Fault (F) field clear. Other status fields in the Fault Status register is cleared by software writing back the value read from the respective fields.
29:0	RO	0	Reserved

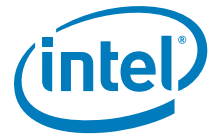

3.5.2.10 FLTEVTDATA[0:1]—Fault Event Data Register

Register: FLTEVTDATA[0:1] Addr: MMIO BAR: VTBAR Offset: 3Ch, 103Ch			
Bit	Attr	Default	Description
31:16	RO	0	<i>Reserved</i>
15:0	RW	0	Interrupt Data

3.5.2.11 FLTEVTADDR[0:1]—Fault Event Address Register

Register: FLTEVTADDR[0:1] Addr: MMIO BAR: VTBAR Offset: 40h, 1040h			
Bit	Attr	Default	Description
31:2	RW	0	Interrupt Address The interrupt address is interpreted as the address of any other interrupt from a PCI Express port.
1:0	RO	0	<i>Reserved</i>

3.5.2.12 FLTEVTUPRADDR[0:1]—Fault Event Upper Address Register

Register: FLTEVTUPRADDR[0:1] Addr: MMIO BAR: VTBAR Offset: 44h, 1044h			
Bit	Attr	Default	Description
31:0	RW	0	Address Integrated I/O supports extended interrupt mode and hence implements this register.

3.5.2.13 PMEN[0:1]—Protected Memory Enable Register

Register: PMEN[0:1] Addr: MMIO BAR: VTBAR Offset: 64h, 1064h			
Bit	Attr	Default	Description
31	RWL	0	Enable Protected Memory , as defined by the PROT_LOW(HIGH)_BASE and PROT_LOW(HIGH)_LIMIT registers. This bit may be locked as RO in Intel TXT mode.
30:1	RV	0	<i>Reserved</i>
0	RO	0	Protected Region Status This bit is set by IIO whenever it has completed enabling the protected memory region per the rules stated in the Intel VT-d spec.



3.5.2.14 PROT_LOW_MEM_BASE[0:1]—Protected Memory Low Base Register

Register: PROT_LOW_MEM_BASE[0:1] Addr: MMIO BAR: VTBAR Offset: 68h, 1068h			
Bit	Attr	Default	Description
31:21	RWL	0	LPD Base 2-MB aligned base address of the low protected DRAM (LPD) region. Note that Intel VT-d engine generated reads/writes (page walk, interrupt queue, invalidation queue read, invalidation status) themselves are allowed toward this region, but no DMA accesses of any kind from any device is allowed toward this region, when enabled. This bit may be locked as RO in Intel TXT mode.
20:0	RV	0	Reserved

3.5.2.15 PROT_LOW_MEM_LIMIT[0:1]—Protected Memory Low Limit Register

Register: PROT_LOW_MEM_LIMIT[0:1] Addr: MMIO BAR: VTBAR Offset: 6Ch, 106Ch			
Bit	Attr	Default	Description
31:21	RWL	0	LPD Limit 2-MB aligned limit address of the low protected DRAM (LPD) region Note that Intel VT-d engine generated reads/writes (page walk, interrupt queue, invalidation queue read, invalidation status) themselves are allowed toward this region, when enabled. This bit may be locked as RO in Intel TXT mode.
20:0	RV	0	Reserved

3.5.2.16 PROT_HIGH_MEM_BASE[0:1]—Protected Memory High Base Register

Register: PROT_HIGH_MEM_BASE[0:1] Addr: MMIO BAR: VTBAR Offset: 70h, 1070h			
Bit	Attr	Default	Description
63:21	RWL	0	HPD Base 2-MB aligned base address of the high protected DRAM (LPD) region. Note that Intel VT-d engine generated reads/writes (page walk, interrupt queue, invalidation queue read, invalidation status) themselves are allowed toward this region, when enabled. This bit may be locked as RO in Intel TXT mode.
20:0	RV	0	Reserved

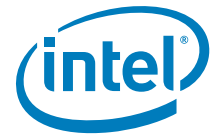

3.5.2.17 PROT_HIGH_MEM_LIMIT[0:1]—Protected Memory Limit Base Register

Register: PROT_HIGH_MEM_LIMIT[0:1] Addr: MMIO BAR: VTBAR Offset: 78h, 1078h			
Bit	Attr	Default	Description
63:21	RWL	0	HPD Limit 2-MB aligned limit address of the high protected DRAM (LPD) region Note that Intel VT-d engine generated reads/writes (page walk, interrupt queue, invalidation queue read, invalidation status) themselves are allowed toward this region, but no DMA accesses of any kind from any device is allowed toward this region, when enabled. This bit may be locked as RO in Intel Trusted Execution Technology (Intel TXT) mode.
20:0	RV	0	Reserved

3.5.2.18 INV_QUEUE_HEAD[0:1]—Invalidation Queue Header Pointer Register

Register: INV_QUEUE_HEAD[0:1] Addr: MMIO BAR: VTBAR Offset: 80h, 1080h			
Bit	Attr	Default	Description
63:19	RV	0	Reserved
18:4	RO	0	Queue Head Specifies the offset (128-bit aligned) to the invalidation queue for the command that will be fetched next by hardware. This field is incremented after the command has been fetched successfully and has been verified to be a valid/supported command.
3:0	RV	0	Reserved

3.5.2.19 INV_QUEUE_TAIL[0:1]—Invalidation Queue Tail Pointer Register

Register: INV_QUEUE_TAIL[0:1] Addr: MMIO BAR: VTBAR Offset: 88h, 1088h			
Bit	Attr	Default	Description
63:19	RV	0	Reserved
18:4	RW	0	Queue Tail Specifies the offset (128-bit aligned) to the invalidation queue for the command that will be written next by software.
3:0	RV	0	Reserved

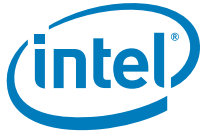

3.5.2.20 INV_QUEUE_ADD[0:1]—Invalidation Queue Address Register

Register: INV_QUEUE_ADD[0:1] Addr: MMIO BAR: VTBAR Offset: 90h, 1090h			
Bit	Attr	Default	Description
63:12	RW	0	IRQ Base This field points to the base of size-aligned invalidation request queue.
11:3	RV	0	<i>Reserved</i>
2:0	RW	0	Queue Size This field specifies the length of the invalidation request queue. The number of entries in the invalidation queue is defined as $2^{(X + 8)}$, where X is the value programmed in this field.

3.5.2.21 INV_COMP_STATUS[0:1]—Invalidation Completion Status Register

Register: INV_COMP_STATUS[0:1] Addr: MMIO BAR: VTBAR Offset: 9Ch, 109Ch			
Bit	Attr	Default	Description
31:1	RV	0	<i>Reserved</i>
0	RW1CS	0	Invalidation Wait Descriptor Complete Indicates completion of Invalidation Wait Descriptor with Interrupt Flag (IF) field set. Once set this field remains set till software clears it.

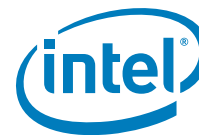

3.5.2.22 INV_COMP_EVT_CTL[0:1]—Invalidation Completion Event Control Register

Register: INV_COMP_EVT_CTL[0:1] Addr: MMIO BAR: VTBAR Offset: A0h, 10A0h			
Bit	Attr	Default	Description
31	RW	1	Interrupt Mask (IM) 0 = No masking of interrupt. When a invalidation event condition is detected, hardware issues an interrupt message (using the Invalidation Event Data & Invalidation Event Address register values). 1 = This is the value on reset. Software may mask interrupt message generation by setting this field. Hardware is prohibited from sending the interrupt message when this field is set.
30	RO	0	Interrupt Pending (IP) Hardware sets the IP field whenever it detects an interrupt condition. Interrupt condition is defined as: <ul style="list-style-type: none"> • An Invalidation Wait Descriptor with Interrupt Flag (IF) field set completed, setting the IWC field in the Fault Status register. • If the IWC field in the Invalidation Event Status register was already set at the time of setting this field, it is not treated as a new interrupt condition. The IP field is kept set by hardware while the interrupt message is held pending. The interrupt message could be held pending due to interrupt mask (IM field) being set, or due to other transient hardware conditions. The IP field is cleared by hardware as soon as the interrupt message pending condition is serviced. This could be due to either: <ol style="list-style-type: none"> 1. Hardware issuing the interrupt message due to either change in the transient hardware condition that caused interrupt message to be held pending or due to software clearing the IM field. 2. Software servicing the IWC field in the Fault Status register.
29:0	RO	0	<i>Reserved</i>

3.5.2.23 INV_COMP_EVT_DATA[0:1]—Invalidation Completion Event Data Register

Register: INV_COMP_EVT_DATA[0:1] Addr: MMIO BAR: VTBAR Offset: A4h, 10A4h			
Bit	Attr	Default	Description
31:16	RO	0	<i>Reserved</i>
15:0	RW	0	Interrupt Data

3.5.2.24 INV_COMP_EVT_ADDR[0:1]—Invalidation Completion Event Address Register

Register: INV_COMP_EVT_ADDR[0:1] Addr: MMIO BAR: VTBAR Offset: A8h, 10A8h			
Bit	Attr	Default	Description
31:2	RW	0	Interrupt Address
1:0	RO	0	<i>Reserved</i>

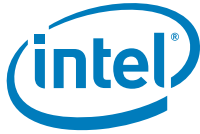

3.5.2.25 INV_COMP_EVT_UPRADDR[0:1]—Invalidation Completion Event Upper Address Register

Register: INV_COMP_EVT_UPRADDR[0:1] Addr: MMIO BAR: VTBAR Offset: ACh, 10ACh			
Bit	Attr	Default	Description
31:0	RW	0	Address Integrated I/O (IIO) supports extended interrupt mode and implements this register.

3.5.2.26 INTR_REMAP_TABLE_BASE[0:1]—Interrupt Remapping Table Base Address Register

Register: INTR_REMAP_TABLE_BASE[0:1] Addr: MMIO BAR: VTBAR Offset: B8h, 10B8h			
Bit	Attr	Default	Description
63:12	RW	0	Intr Remap Base This field points to the base of the page-aligned interrupt remapping table. If the Interrupt Remapping Table is larger than 4-KB in size, it must be size-aligned. Reads of this field returns value that was last programmed to it.
11	RO	0	IA32 Extended Interrupt Enable mode is not supported. IA-32 system is operating in legacy IA-32 interrupt mode. Hardware interprets only 8-bit APICID in the Interrupt Remapping Table entries.
10:4	RV	0	<i>Reserved</i>
3:0	RW	0	Size This field specifies the size of the interrupt remapping table. The number of entries in the interrupt remapping table is $2^{(X+1)}$, where X is the value programmed in this field.

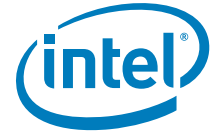

3.5.2.27 FLTREC[10,7:0]—Fault Record Register

FLTREC[10] register is for the Isochronous Intel VT-d engine and [7:0] registers are for non-isochronous Intel VT-d engine.

Register: FLTREC[10,7:0] Addr: MMIO BAR: VTBAR Offset: 1100h, 170h, 160h, 150h, 140h, 130h, 120h, 110h, 100h			
Bit	Attr	Default	Description
127	RW1CS	0	Fault (F) Hardware sets this field to indicate a fault is logged in this fault recording register. When this field is set, hardware may collapse additional faults from the same requestor (SID). Software writes the value read from this field to clear it.
126	RO	0	<i>Reserved</i>
125:124	RO	0	<i>Reserved</i>
123:104	RV	0	<i>Reserved</i>
103:96	ROS	0	Fault Reason Reason for the first translation fault. See Intel VT-d specification for details. This field is only valid when Fault bit is set.
95:80	RV	0	<i>Reserved</i>
79:64	ROS	0	Source Identifier Requester ID that faulted. Valid only when F bit is set.
63:12	ROS	0	GPA 4-K aligned GPA for the faulting transaction. Valid only when F field is set.
11:0	RV	0	<i>Reserved</i>

3.5.2.28 INVADDRREG[0:1]—Invalidate Address Register

Register: INVADDRREG[0:1] Addr: MMIO BAR: VTBAR Offset: 200h, 1200h			
Bit	Attr	Default	Description
63:12	RW	0	Address (ADDR) To request a page-specific invalidation request to hardware, software must first write the corresponding guest physical address to this register, and then issue a page-specific invalidate command through the IOTLBINV register.
11:7	RV	0	<i>Reserved</i>
6	RW	0	Invalidation Hint The field provides hint to hardware to preserve or flush the respective non-leaf page-table entries that may be cached in hardware. 0 = Software may have modified both leaf and non-leaf page-table entries corresponding to mappings specified in the ADDR and AM fields. On a page-selective invalidation request, IIO must flush both the cached leaf and nonleaf page-table entries corresponding to mappings specified by ADDR and AM fields. IIO performs a domain-level invalidation on non-leaf entries and page-selective-domain-level invalidation at the leaf level 1 = Software has not modified any non-leaf page-table entries corresponding to mappings specified in the ADDR and AM fields. On a page-selective invalidation request, IIO preserves the cached non-leaf page-table entries corresponding to mappings specified by ADDR and AM fields and performs only a page-selective invalidation at the leaf level.
5:0	RW	0	Address Mask (AM) IIO supports values of 0-9. All other values result in undefined results.



3.5.2.29 IOTLBINV[0:1]—IOTLB Invalidate Register

Register: IOTLBINV[0:1] Addr: MMIO BAR: VTBAR Offset: 208h, 1208h			
Bit	Attr	Default	Description
63	RW	0	Invalidate IOTLB cache (IVT) Software requests IOTLB invalidation by setting this field. Software must also set the requested invalidation granularity by programming the IIRG field. Hardware clears the IVT field to indicate the invalidation request is complete. Hardware also indicates the granularity at which the invalidation operation was performed through the IAIG field. Software must read back and check the IVT field to be clear to confirm the invalidation is complete. When IVT field is set, software must not update the contents of this register (and Invalidate Address register, if it is being used), nor submit new IOTLB invalidation requests.
62:60	RW	0	IOTLB Invalidation Request Granularity (IIRG) When requesting hardware to invalidate the IOTLB (by setting the IVT field), software writes the requested invalidation granularity through this IIRG field. Following are the encoding for the 3-bit IIRG field. 000 = Reserved. IIO ignores the invalidation request and reports invalidation complete by clearing the IVT field and reporting 00 in the AIG field. 001 = Global Invalidation request. 010 = Domain-selective invalidation request. The target domain-ID must be specified in the DID field. 011 = Page-selective invalidation request. The target address, mask and invalidation hint must be specified in the Invalidate Address register, the domain-ID must be provided in the DID field. 101–111 = Reserved. IIO ignores the invalidation request and completes the invalidation by clearing the IVT field and reporting 000 in the IAIG field.
59:57	RO	0	IOTLB Actual Invalidation Granularity (IAIG) Hardware reports the granularity at which an invalidation request was proceed through the AIG field at the time of reporting invalidation completion (by clearing the IVT field). The following are the encoding for the 3-bit IAIG field. 000 = Reserved. This indicates hardware detected an incorrect invalidation request and ignored the request. 001 = Global Invalidation performed. IIO sets this in response to a global IOTLB invalidation request. 010 = Domain-selective invalidation performed using the domain-ID that was specified by software in the DID field. IIO sets this in response to a domain selective IOTLB invalidation request. 011 = IIO sets this in response to a page selective invalidation request. 100–111 = Reserved
56:50	RV	00h	<i>Reserved</i>
49	RW	0	Drain Reads IIO uses this to drain or not drain reads on an invalidation request.
48	RW	0	Drain Writes IIO uses this to drain or not drain writes on an invalidation request.
47:32	RW	0	Domain ID Domain to be invalidated and is programmed by software for both page and domain selective invalidation requests. IIO ignores the bits 47:40 since it supports only an 8 bit Domain ID.
31:0	RV	00000000h	<i>Reserved</i>



3.6 Intel® Trusted Execution Technology (Intel® TXT) Register Map

Table 3-15. Intel® Trusted Execution Technology Registers

TXT.STS	00h		80h
	04h		84h
TXT.ESTS	08h		88h
	0Ch		8Ch
TXT.THREADS.EXISTS	10h		90h
	14h		94h
	18h		98h
	1Ch		9Ch
TXT.THREADS.JOINS	20h		A0h
	24h		A4h
	28h		A8h
	2Ch		ACh
TXT.ERRORCODE	30h		B0h
	34h		B4h
TXT.Cmd.Reset	38h		B8h
	3Ch		BCh
	40h		C0h
	44h		C4h
TXT.Cmd.Close-Private	48h		C8h
	4Ch		CCh
	50h		D0h
	54h		D4h
	58h		D8h
	5Ch		DCh
	60h		E0h
	64h		E4h
	68h		E8h
	6Ch		ECh
	70h		F0h
	74h		F4h
	78h		F8h
	7Ch		FCh



Table 3-16. Intel® Trusted Execution Technology Registers, cont'd

TXT.VER.QPIIF	100h		180h
	104h		184h
	108h		188h
	10Ch		18Ch
TXT.ID	110h		190h
	114h		194h
	118h		198h
	11Ch		19Ch
	120h		1A0h
	124h		1A4h
	128h		1A8h
	12Ch		1ACh
	130h		1B0h
	134h		1B4h
	138h		1B8h
	13Ch		1BCh
	140h		1C0h
	144h		1C4h
	148h		1C8h
	14Ch		1CCh
	150h		1D0h
	154h		1D4h
	158h		1D8h
	15Ch		1DCh
	160h		1E0h
	164h		1E4h
	168h		1E8h
	16Ch		1ECh
	170h		1F0h
	174h		1F4h
	178h		1F8h
	17Ch		1FCh



Table 3-17. Intel® Trusted Execution Technology Registers, cont'd

	200h		280h
	204h		284h
	208h		288h
	20Ch		28Ch
	210h	TXT.MLE.JOIN	290h
	214h		294h
	218h		298h
	21Ch		29Ch
	220h		2A0h
	224h		2A4h
	228h		2A8h
	22Ch		2ACh
TXT.Cmd.Lock.Base	230h		2B0h
	234h		2B4h
TXT.Cmd.Unlock.Base	238h		2B8h
	23Ch		2BCh
	240h		2C0h
	244h		2C4h
	248h		2C8h
	24Ch		2CCh
	250h		2D0h
	254h		2D4h
	258h		2D8h
	25Ch		2DCh
	260h		2E0h
	264h		2E4h
	268h	2E8h	
	26Ch	2ECh	
TXT.SINIT.MEMORY.BASE	270h	2F0h	
	274h	2F4h	
TXT.SINIT.MEMORY.SIZE	278h	2F8h	
	27Ch	2FCh	



Table 3-18. Intel® Trusted Execution Technology Registers, cont'd

TXT.Heap.Base	300h		TXT.Cmd.Opn. Locality1	380h
	304h			384h
TXT.Heap.Size	308h		TXT.Cmd.Close. Locality1	388h
	30Ch			38Ch
TXT.MSEG.Base	310h		TXT.Cmd.Opn. Locality2	390h
	314h			394h
TXT.MSEG.Size	318h		TXT.Cmd.Close. Locality2	398h
	31Ch			39Ch
TXT.Scratchpad0	320h			3A0h
	324h			3A4h
TXT.Scratchpad1	328h			3A8h
	32Ch			3ACh
	330h			3B0h
	334h			3B4h
	338h			3B8h
	33Ch			3BCh
	340h			3C0h
	344h			3C4h
	348h			3C8h
	34Ch			3CCh
	350h			3D0h
	354h			3D4h
	358h			3D8h
	35Ch			3DCh
	360h			3E0h
	364h			3E4h
	368h			3E8h
	36Ch			3ECh
	370h			3F0h
	374h			3F4h
	378h			3F8h
	37Ch			3FCh

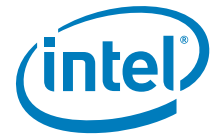
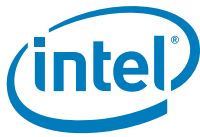

Table 3-19. Intel® Trusted Execution Technology Registers, cont'd

TXT.Public.Key	400h		480h
	404h		484h
	408h		488h
	40Ch		48Ch
	410h		490h
	414h		494h
	418h		498h
	41Ch		49Ch
	420h		4A0h
424h	4A4h		
428h	4A8h		
42Ch	4ACh		
430h	4B0h		
434h	4B4h		
438h	4B8h		
43Ch	4BCh		
440h	4C0h		
444h	4C4h		
448h	4C8h		
44Ch	4CCh		
450h	4D0h		
454h	4D4h		
458h	4D8h		
45Ch	4DCh		
460h	4E0h		
464h	4E4h		
468h	4E8h		
46Ch	4ECh		
470h	4F0h		
474h	4F4h		
478h	4F8h		
47Ch	4FCh		



3.6.1 Intel® TXT Space Registers

The Intel TXT registers adhere to the public and private attributes described in XREF.

As described previously, each Intel TXT register may have up to three ways to access it. These are given the following symbolic names. TXT_TXT is the memory region starting at FED2_0000h when it is accessed using the special Intel TXT read or write commands. TXT_PR is the memory region starting at FED2_0000h when it is accessed using normal read or write commands. TXT_PB is the memory region starting at FED3_0000h accessed using any read or write command. TXT_PB_noWR is similar to TXT_PB but write accesses have no affect.

The register tables below sometimes list more than one base for a register. Normally this would indicate that there is more than one register. However, in the current section it indicates that there is a single register which can be accessed in more than one way.

3.6.1.1 TXT.STS—Intel® TXT Status Register

This register is used to read the status of the Intel TXT Command/Status Engine functional block in the Shortened Product Name.

General Behavioral Rules:

- This is a read-only register, so writes to this register will be ignored.
- This register is available in both the Public and Private Intel TXT configuration spaces.

(Sheet 1 of 2)

Bit	Attr	Default	Description
Base: TXT_TXT Offset: 0000h Base: TXT_PR Offset: 0000h Base: TXT_PB Offset: 0000h			
31:18	RV	0h	Reserved
17	RO	0	TXT.SEQ.IN.PROGRESS This bit is set when the TXT.SEQUENCE.START msg is received from a processor. This bit is cleared when the TXT.SEQUENCE.DONE msg is received from a processor. If this bit is set and the chipset receives another TXT.SEQUENCE.START message, then the chipset treats this as a rogue attack and does TXT_RESET# and sets Rogue status bit.
16	RO	0	TXT.LOCALITY2.OPEN.STS This bit is set when either the TXT.CMD.OPEN.LOCALITY2 command or the TXT.CMD.OPEN.PRIVATE is seen by the chipset. It is cleared on reset or when either TXT.CMD.CLOSE.LOCALITY2 or TXT.CMD.CLOSE.PRIVATE is seen. This bit can be used by sw as a positive indication that the command has taken effect. Note that hardware should not set or clear this bit until the internal hardware will guarantee that incoming cycles will be decoded based on the state change caused by the OPEN or CLOSE command.
15	RO	0	TXT.LOCALITY1.OPEN.STS This bit is set when the TXT.CMD.OPEN.LOCALITY1 command is seen by the chipset. It is cleared on reset or when TXT.CMD.CLOSE.LOCALITY1 is seen. This bit can be used by sw as a positive indication that the command has taken effect. Note that hardware should not set or clear this bit until the internal hardware will guarantee that incoming cycles will be decoded based on the state change caused by the OPEN or CLOSE command.



(Sheet 2 of 2)

Bit	Attr	Default	Description
Base: TXT_TXT Offset: 0000h Base: TXT_PR Offset: 0000h Base: TXT_PB Offset: 0000h			
14	RO	0	TXT.LOCALITY3.OPEN.STS This bit is set when the TXT.CMD.OPEN.LOCALITY3 command is seen by the chipset. It is cleared on reset or when TXT.CMD.CLOSE.LOCALITY3 is seen. This bit can be used by sw as a positive indication that the command has taken effect. Note that hardware should not set or clear this bit until the internal hardware will guarantee that incoming cycles will be decoded based on the state change caused by the OPEN or CLOSE command.
13	RV	0	<i>Reserved</i>
12	RV	0	<i>Reserved</i>
11	RO	0	TXT.MEM-CONFIG-OK.STS (TXTMCONFOKSTS) This bit indicates whether the chipset has received and accepted the TXT.CMD.MEM-CONFIG-CHECKED TXT command. This bit is cleared by PCI reset or by the TXT.CMD.UNLOCK-MEMCONFIG command. 0 = Indicates that memory configuration checking has not been performed. This is the default state after PCI reset. This bit is also set to 0 after the chipset has accepted the TXT.CMD.UNLOCK-MEM-CONFIG command. 0 = Indicates that memory configuration checking has been performed. This bit is set to one when the chipset accepts the TXT.CMD.MEM-CONFIG-CHECKED TXT command.
10:8	RV	0	<i>Reserved</i>
7	RO	0	TXT.PRIVATE-OPEN.STS This bit will be set to 1 when the TXT.CMD.OPEN-PRIVATE is performed. This bit is cleared by the TXT.CMD.CLOSE-PRIVATE or by a system reset.
6	RO	0	TXT.MEM-CONFIG-LOCK.STS This bit will be set to 1 when the memory configuration has been locked. This bit is cleared by TXT.CMD.UNLOCK.MEMCONFIG or by a system reset. When this bit is set registers VTCTRL (D20:F0:7Ch) and VTBAR (D20:F0:78h) will be locked. And these registers will be unlocked when this bit is clear.
5	RO	0	TXT.BASE.LOCKED.STS This bit will be set to 1 when the TXT.LOCK.BASE command is issued. This bit is cleared by TXT.UNLOCK.BASE or by a system reset. When this bit is set, TXT space registers TXT_HEAP_BASE, TXT_HEAP_SIZE, TXT_MSEG_BASE, TXT_MSEG_SIZE, TXT_SCRATCHPAD0 and TXT_SCRATCHPAD1 will be locked. And these registers will be unlocked when this bit is clear.
4:2	RV	0h	<i>Reserved</i>
1	RO	1	SEXIT.DONE.STS This bit is set when all of the bits in the TXT.THREADS.JOIN register are clear 0 (using TXT_JOINS_CLEAR command). Thus, this bit will be set immediately after reset (since the bits are all 0).
0	RO	0	SENER.DONE.STS The chipset sets this bit when TXT.THREADS.JOIN = TXT.THREAD.EXISTS and TXT.THREADS.JOIN != 0. When any of the threads does the TXT.JOINS.CLEAR to clear the set bit in TXT.THREADS.JOIN register, the TXT.THREADS.JOIN and TXT.THREADS.EXISTS registers will not be equal, so the chipset will clear this bit.



3.6.1.2 TXT.ESTS—Intel® TXT Error Status Register

This register is used to read the status associated with various errors that might be detected.

General Behavioral Rules:

- This register is available for read-only access from the Public configuration space.
- This register is available for read and write access from the Private configuration space. Each status bit is cleared by writing to this register with a 1 in the corresponding bit position.
- The bits in this register are cleared by writing a 1 to the corresponding bit positions. These bits are not cleared by a standard system reset.

Base: TXT_TXT Offset: 0008h Base: TXT_PR Offset: 0008h Base: TXT_PB_noWR Offset: 0008h			
Bit	Attr	Default	Description
7	RV	0	<i>Reserved</i>
6	RW1C	0	TXT.WAKE-ERROR.STS The chipset sets this bit when it detects that there might have been secrets in memory and a reset or power failure occurred. If this bit is set after a system reset, the chipset will prevent memory accesses until specifically enabled. The software that is authorized to enable the memory accesses will also be responsible for clearing the secrets from memory. Software can read chipset-specific registers to determine the specific cause of the error. The location of those bits is beyond the scope of this specification. On a reset, if NOP_ACK_WITH_SECRETS is received, then this bit is set to 1. On a reset, if NOP_ACK_WITHOUT_SECRETS is received, then this bit is cleared to 0. This bit must be cleared if a read to FED4_0000h returns a 1 in Bit 0.
5	RWC	0	TXT.ALIAS.FAULT Set when the platform determines there is an address alias error that could be a security violation. Software can clear this bit by writing a 1 to it.
4	RWC	0	<i>Reserved.</i> This bit is set when the processor issues a write to TXT.ESTS.SET register with bit [4] = 1.
3	RWC	0	<i>Reserved.</i> This bit is set when the processor issues a write to TXT.ESTS.SET register with bit [3] = 1.
2	RWC	0	TXT.MEMORY.ATTACK This bit is set when there is some illegal read of DRAM. This bit is set when the processor issues a write to TXT.ESTS.SET register with bit [2]=1. Software can clear this bit by writing a 1 to it.
1	RW1C	0	TXT.ROGUE.STS The chipset sets this bit to indicate that some thread has left the secure environment improperly.
0	ROS	0	TXT.POISON Cycle Received The chipset sets this bit to indicate that the TXT.POISON cycle has been received. Note that this bit is sticky and is only cleared by a power cycle. The effect of TXT.POISON is also held active through reset and so the chipset is poisoned even after the reset. The only way to clear the poison effect is to do a power cycle.

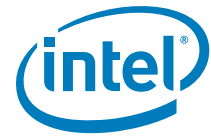

3.6.1.3 TXT.THREADS.EXISTS—Intel® TXT Thread Exists Register

This register is used to read which threads are registered as Intel TXT capable.

General Behavioral Rules:

- This is a read-only register, so writes to this register will be ignored.
- This register is available in both the Public and Private Intel TXT configuration spaces.

Base: TXT_TXT Offset: 0010h Base: TXT_PR Offset: 0010h Base: TXT_PB Offset: 0010h			
Bit	Attr	Default	Description
63:0	RO	0h	TXT.THREADS.EXISTS[63:0] This bit field indicates the threads that exist in the platform. Each thread sets its bit in this register by writing a 1 to the corresponding TXT.EXISTS.SET register. How each thread determines which bit to write is platform dependent. These bits can be cleared by writing a 1 to the corresponding bit in the TXT.EXISTS.CLEAR register.

3.6.1.4 TXT.THREADS.JOIN—Intel® TXT Threads Join Register

This register is used to count the threads that have joined the Intel TXT environment.

General Behavioral Rules:

- This is a read-only register, so writes to this register will be ignored.
- This register is available in both the Public and Private Intel TXT configuration spaces.

Base: TXT_TXT Offset: 0020h Base: TXT_PR Offset: 0020h Base: TXT_PB Offset: 0020h			
Bit	Attr	Default	Description
63:0	RO	0h	TXT.THREADS.JOIN[63:0] This bit field indicates the threads that exist in the platform. Each thread sets its bit in this register by writing a 1 to the corresponding TXT.JOINS.SET register. How each thread determines which bit to write is platform dependent. These bits can be cleared by writing a 1 to the corresponding bit in the TXT.JOINS.CLEAR register.



3.6.1.5 TXT.ERRORCODE—Intel® TXT Error Code Register

When software discovers an error, it can write this scratch-pad register. However, the register is sticky and reset only by a power-good reset, and so allows diagnostic software (after the hard reset) to determine why the SENTER sequence failed (by examining various status bits).

General Behavioral Rules:

- This is a read-only register in the public Intel TXT configuration space.
- This register is for read and write in the private Intel TXT configuration space.
- Accesses to this register are done with 1-, 2-, or 4-byte writes and reads.
- The default value of this register is 00000000h.
- Access to this register has no other effect on the chipset other than reading or writing the contents of this register.

Base: TXT_TXT Offset: 0030h Base: TXT_PR Offset: 0030h Base: TXT_PB_noWROffset: 0030h			
Bit	Attr	Default	Description
31:0	RWS	0h	TXT_ERRORCODE[31:0] This register is a scratch pad register and is defined by the software usage model.

3.6.1.6 TXT.CMD.RESET—Intel® TXT System Reset Command Register

When this command is invoked, the chipset resets the entire platform.

General Behavioral Rules:

- This is a write-only register.
- This register is only available in the private Intel TXT configuration space.
- Accesses to this register are done with 1-byte writes.
- The data bits associated with this command are undefined and have no specific meaning.

Base: TXT_TXT Offset: 0038h Base: TXT_PR Offset: 0038h			
Bit	Attr	Default	Description
7:0	WO	0h	N/A

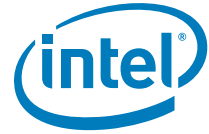

3.6.1.7 TXT.CMD.CLOSE_PRIVATE—Intel® TXT Close Private Command Register

The processor that authenticates the SEXIT code does this to prevent the Intel TXT Private configuration space from being accessed using standard memory read/write cycles.

General Behavioral Rules:

- This is a write-only register.
- This register is only available in the Private Intel TXT configuration space.
- Accesses to this register are done with 1-byte writes.
- The data bits associated with this command are undefined and have no specific meaning.

Base: TXT_TXT Offset: 0048h Base: TXT_PR Offset: 0048h			
Bit	Attr	Default	Description
7:0	WO	0h	N/A

3.6.1.8 TXT.VER.QPIIF

This register provides chipset version information. Important to MLE to detect/debug chipsets.

Base: TXT_TXT Offset: 0100h Base: TXT_PR Offset: 0100h			
Bit	Attr	Default	Description
7:0	WO		chipset revision ID

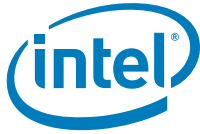

3.6.1.9 TXT.ID—Intel® TXT Identifier Register

This register holds TXT ID for IIO.

General Behavioral Rules:

- This register is available in both the Public and Private Intel TXT configuration spaces.

Base: TXT_TXT Offset: 0110h Base: TXT_PR Offset: 0110h Base: TXT_PB Offset: 0110h			
Bit	Attr	Default	Description
63:48	RWLBS	0h	TXT.ID.EXT This is an Extension onto the other ID fields. This register will be locked for access using Intel TXT public space when the TXT.CMD.LOCK.BASE is issued. When locked this register is updated by private or Intel TXT writes, but not public writes.
47:32	RO	0h	TXT.RID Revision ID This field is revision dependent. Refer to the <i>Intel® Core™ i7-800 and i5-700 Desktop Processor Series Specification Update</i> for the value of the Revision ID Register.
31:16	RO	C002h	TXT.DID - Device ID C002h
15:0	RO	8086h	TXT.VID Vendor ID = 8086 for Intel corporation.

Note: Intel Chipset Implementation Notes: For IIO, the TXT.MIF.LARGE.CAP bit will be 1. IIO will support having any pointers point to addresses above 4G.

3.6.1.10 TXT.CMD.LOCK.BASE—Intel® TXT Lock Base Command Register

When this command is invoked, the chipset will lock the registers listed in the table of registers and commands. The command may be used by SCHECK or by SINIT to lock down the location of code or any other information that needs to be passed between SCHECK and the VMM and its loader.

General Behavioral Rules:

- This is a write-only register.
- This register is only available in the Private Intel TXT configuration space.
- Accesses to this register are done with 1-byte writes.
- The data bits associated with this command are undefined and have no specific meaning.

Base: TXT_TXT Offset: 0230h Base: TXT_PR Offset: 0230h			
Bit	Attr	Default	Description
7:0	WO	0h	N/A

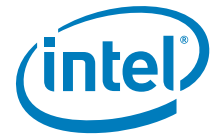

3.6.1.11 TXT.CMD.UNLOCK.BASE—Intel® TXT Unlock Base Command Register

When this command is invoked, the chipset unlocks the registers listed in the table of registers and commands. When unlocked, the registers affected by this command may be written with public cycles, as well as private or Intel TXT cycles.

General Behavioral Rules:

- This is a write-only register.
- This register is only available in the Private Intel TXT configuration space.
- Accesses to this register are done with 1-byte writes.
- The data bits associated with this command are undefined and have no specific meaning.

Base: TXT_TXT Offset: 0238h Base: TXT_PR Offset: 0238h			
Bit	Attr	Default	Description
7:0	WO	0h	N/A

3.6.1.12 TXT.SINIT.MEMORY.BASE—Intel® TXT SINIT Code Base Register

This register holds a pointer to the base address of the SINIT code.

General Behavioral Rules:

- This is a read/write register.
- This register is available for reads or writes in the Public Intel TXT configuration space.
- This register is available for read or write in the Private Intel TXT configuration space.

Base: TXT_TXT Offset: 0270h Base: TXT_PR Offset: 0270h Base: TXT_PB Offset: 0270h			
Bit	Attr	Default	Description
63:40	RO	0h	Reserved
39:12	RW	0h	TXT.SINIT.BASE[39:12] Base address of the SINIT code. Note: Only Bits 39:12 are implemented because the SINIT code must be aligned to a 4-KB page boundary.
11:0	RO	0h	Reserved

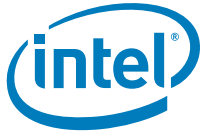

3.6.1.13 TXT.SINIT.MEMORY.SIZE—Intel® TXT SINIT Memory Size Register

This register indicates the size of the SINIT memory space.

General Behavioral Rules:

- This is a read/write register.
- This register is available for read or write in the Private Intel TXT configuration space.

Base: TXT_TXT Offset: 0278h Base: TXT_PR Offset: 0278h Base: TXT_PB Offset: 0278h			
Bit	Attr	Default	Description
63:0	RW	0h	TXT.SINIT.SIZE[63:0] Hardware does not use the information contained in this register. It is used as a mailbox between two pieces of software.

3.6.1.14 TXT.MLE.JOIN—Intel® TXT MLE Join Base Register

Holds a pointer to the base address of the SVM join code used by the RLPs.

General Behavioral Rules:

- This is a read/write register.
- This register is available for read or write in the Public Intel TXT configuration space.
- This register is available for read or write in the Private Intel TXT configuration space.

Base: TXT_TXT Offset: 0290h Base: TXT_PR Offset: 0290h Base: TXT_PB Offset: 0290h			
Bit	Attr	Default	Description
63:40	RO	0h	<i>Reserved</i>
39:0	RW	0h	TXT.MLE.JOIN[39:0] Base address of the MLE join code.

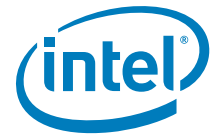

3.6.1.15 TXT.HEAP.BASE—Intel® TXT HEAP Code Base Register

This register holds a pointer to the base address for the Intel TXT Heap.

General Behavioral Rules:

- This is a read/write register.
- This register is locked by TXT.CMD.LOCK.BASE. When locked this register is updated by private or Intel TXT writes, but not public writes
- This register is available for read or write in the Public Intel TXT configuration space.
- This register is available for read or write in the Private Intel TXT configuration space.

Base: TXT_TXT Offset: 0300h Base: TXT_PR Offset: 0300h Base: TXT_PB Offset: 0300h			
Bit	Attr	Default	Description
63:0	RWLB	0h	TXT.HEAP.BASE[63:0] Base address of the heap. This register will be locked for access using Intel TXT public space when the TXT.CMD.LOCK.BASE is issued. When locked this register is updated by private or Intel TXT writes, but not public writes.

3.6.1.16 TXT.HEAP.SIZE—Intel® TXT HEAP Size Register

This register indicates the size of the Intel TXT Heap.

General Behavioral Rules:

- This is a read/write register.
- This register is locked by TXT.CMD.LOCK.BASE. When locked this register is updated by private or Intel TXT writes, but not public writes
- This register is available for read or write in the Public Intel TXT configuration space.
- This register is available for read or write in the Private Intel TXT configuration space.

Base: TXT_TXT Offset: 0308h Base: TXT_PR Offset: 0308h Base: TXT_PB Offset: 0308h			
Bit	Attr	Default	Description
63:0	RWLB	0h	TXT.HEAP.SIZE[63:0] Size of the total device space in bytes. This register will be locked for access using Intel TXT public space when the TXT.CMD.LOCK.BASE is issued. When locked this register is updated by private or Intel TXT writes, but not public writes.



3.6.1.17 TXT.MSEG.BASE—Intel® TXT MSEG Base Register

This register holds a pointer to the base address for the TXT MSEG.

General Behavioral Rules:

- This is a read/write register.
- This register is locked by TXT.CMD.LOCK.BASE. When locked it may not be changed by any writes, whether they are Intel TXT private or public writes.
- This register is available for read or write in the Public Intel TXT configuration space.
- This register is available for read or write in the Private Intel TXT configuration space.

Base: TXT_TXT Offset: 0310h Base: TXT_PR Offset: 0310h Base: TXT_PB Offset: 0310h			
Bit	Attr	Default	Description
63:0	RWL	0h	TXT.MSEG.BASE[63:0] This register will be locked for access using Intel TXT public space when the TXT.CMD.LOCK.BASE is issued. When locked this register is updated by private or Intel TXT writes, but not public writes.

3.6.1.18 TXT.MSEG.SIZE—Intel® TXT MSEG Size Register

This register holds the size (in bytes) of the Intel TXT MSEG region.

General Behavioral Rules:

- This is a read/write register.
- This register is locked by TXT.CMD.LOCK.BASE. When locked it may not be changed by any writes, whether they are Intel TXT private or public writes.
- This register is available for read or write in the Public Intel TXT configuration space.
- This register is available for read or write in the Private Intel TXT configuration space.

Base: TXT_TXT Offset: 0318h Base: TXT_PR Offset: 0318h Base: TXT_PB Offset: 0318h			
Bit	Attr	Default	Description
63:0	RWL	0h	TXT.MSEG.SIZE[63:0] This register will be locked for access using Intel TXT public space when the TXT.CMD.LOCK.BASE is issued. When locked this register is updated by private or Intel TXT writes, but not public writes.

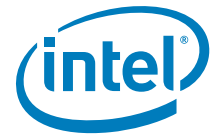

3.6.1.19 TXT.SCRATCHPAD0—Intel® TXT Scratch Pad Register 0

Intel TXT Scratch Pad Register.

General Behavioral Rules:

- This is a read/write register.
- This register is locked by TXT.CMD.LOCK.BASE. When locked this register is updated by private or Intel TXT writes, but not public writes.
- This register is available for read or write in the Public and Private Intel TXT configuration space.

Base: TXT_TXT Offset: 0320h Base: TXT_PR Offset: 0320h Base: TXT_PB Offset: 0320h			
Bit	Attr	Default	Description
63:0	RWLB	0h	TXT.SCRATCHPAD0[63:0] This register will be locked for access using Intel TXT public space when the TXT.CMD.LOCK.BASE is issued. When locked this register is updated by private or Intel TXT writes, but not public writes.

3.6.1.20 TXT.SCRATCHPAD1—Intel® TXT Scratch Pad Register 1

Intel TXT Scratch Pad Register.

General Behavioral Rules:

- This is a read/write register.
- This register is available for read or write in the Public and Private Intel TXT configuration space.

Base: TXT_TXT Offset: 0328h Base: TXT_PR Offset: 0328h Base: TXT_PB Offset: 0328h			
Bit	Attr	Default	Description
63:0	RW	0h	TXT.SCRATCHPAD1[63:0]



3.6.1.21 TXT.CMD.OPEN.LOCALITY1—Intel® TXT Open Locality 1 Command

Enables Locality 1 decoding in chipset.

General Behavioral Rules:

- This is a write-only register.
- This register is only available in the private Intel TXT configuration space.
- Accesses to this register are done with 1-byte writes.
- The data bits associated with this command are undefined and have no specific meaning.

Base: TXT_TXT Offset: 0380h			
Bit	Attr	Default	Description
7:0	WO	0h	N/A

3.6.1.22 TXT.CMD.CLOSE.LOCALITY1—Intel® TXT Close Locality 1 Command

Disables Locality 1 decoding in chipset.

General Behavioral Rules:

- This is a write-only register.
- This register is only available in the private Intel TXT configuration space.
- Accesses to this register are done with 1-byte writes.
- The data bits associated with this command are undefined and have no specific meaning.

Base: TXT_TXT Offset: 0388h Base: TXT_PR Offset: 0388h			
Bit	Attr	Default	Description
7:0	WO	0h	N/A

3.6.1.23 TXT.CMD.OPEN.LOCALITY2—Intel® TXT Open Locality 2 Command

Enables Locality 2 decoding in chipset. This command will open Locality2 for decode as an Intel TXT space by the chipset. This command is either an TXTMW or a private write when private is open.

Note: OPEN.PRIVATE will open Locality 2 and CLOSE.PRIVATE will close Locality 2 without requiring an explicit OPEN/CLOSE.CMD.LOCALITY3 cycle.

The OPEN/CLOSE Locality 2 commands are to be used in the window while PRIVATE is open, but the VMM wants to close or re-open the Locality 2 space while still leaving PRIVATE open.

If the locality is closed, then cycles to the Locality 2 address range are not decoded as Intel TXT cycles.

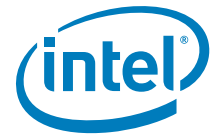

Note: PRIVATE space must also be Open for Locality 2 to be decoded as Intel TXT space.

General Behavioral Rules:

- This is a write-only register.
- This register is only available in the private Intel TXT configuration space.
- Accesses to this register are done with 1-byte writes.
- The data bits associated with this command are undefined and have no specific meaning.

Base: TXT_TXT Offset: 0390h Base: TXT_PR Offset: 0390h			
Bit	Attr	Default	Description
7:0	WO	0h	N/A

3.6.1.24 TXT.CMD.CLOSE.LOCALITY2—Intel® TXT Close Locality 2 Command

Disables Locality 2 decoding in chipset. When closed, the chipset may decode this range as normal memory space, or it may abort cycles to this range. This command is either an TXTMW or a private write when private is open.

General Behavioral Rules:

- This is a write-only register.
- Accesses to this register are done with 1-byte writes.
- The data bits associated with this command are undefined and have no specific meaning.

Base: TXT_TXT Offset: 0398h Base: TXT_PR Offset: 0398h			
Bit	Attr	Default	Description
7:0	WO	0h	N/A

3.6.1.25 TXT.PUBLIC.KEY—Intel® TXT Public Key Hash Register

Chipset public key hash.

Base: TXT_TXT Offset: 0400h Base: TXT_PR Offset: 0400h Base: TXT_PB Offset: 0400h			
Bit	Attr	Default	Description
256:0	RO		N/A

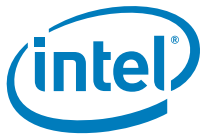

3.7 Intel® QuickPath Interconnect Device/Functions

The following device/functions control the Intel QuickPath Interconnect coherent link.

Register Group	Device	Function	Comment
Intel QuickPath Interconnect Port	16	0	Link and PPR
Intel QuickPath Interconnect Port	16	1	Routing and protocol

Table 3-20. Intel® QuickPath Interconnect Physical/Link Map Port 0 (Device 16)

DID	VID	00h	80h
PCISTS	PCICMD	04h	84h
CCR	RID	08h	88h
HDR	CLS	0Ch	8Ch
		10h	90h
		14h	94h
		18h	98h
		1Ch	9Ch
		20h	A0h
		24h	A4h
		28h	A8h
SID	SVID	2Ch	ACH
		30h	B0h
	CAPPTR	34h	B4h
		38h	B8h
		40h	BCh
		40h	C0h
		44h	QPI[0]LCL C4h
		48h	C8h
		4Ch	CCh
		50h	D0h
		54h	D4h
		58h	D8h
		5Ch	DCh
		60h	E0h
		64h	E4h
		68h	E8h
		6Ch	ECh
		70h	F0h
		74h	F4h
		78h	QPI[0]LCRDC F8h
		7Ch	FCh

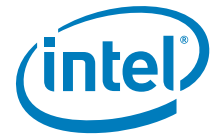

3.7.1 Intel® QuickPath Interconnect Link Layer Registers

The link layer register are defined for the coherent link. There is a special attribute on some link layer registers to handle the link layer specific reset. The link layer only has hard and soft resets. 'N' attribute indicates that the register is reset on a link layer hard reset. 'NN' indicates that the register is reset on any link layer reset (hard or soft).

3.7.1.1 SVID—Subsystem Vendor ID

Register: SVID Device: 16 Function: 0,1 Offset: 2Ch			
Bit	Attr	Default	Description
7:0	RWO	00h	Subsystem Vendor Identification This field is programmed during boot-up to indicate the vendor of the system board. After it has been written once, it becomes read only.

3.7.1.2 SID—Subsystem Device ID

Register: SID Device: 16 Function: 0,1 Offset: 2Eh			
Bit	Attr	Default	Description
7:0	RWO	00h	Subsystem Identification Number Assigned by the subsystem vendor to uniquely identify the subsystem.

3.7.1.3 CAPPTR—Capability Pointer

The CAPPTR provides the offset to the location of the first device capability in the capability list.

Register: CAPPTR Device: 16 Function: 0,1 Offset: 34h			
Bit	Attr	Default	Description
7:0	RO	00h: F 0/1	Capability Pointer Points to the first capability structure for the device.



3.7.1.4 QPI [0]LCL—Intel® QuickPath Interconnect Link Control

Register per Intel QuickPath Interconnect port. This register is used for Control of Link Layer.

Register: QPI [0]LCL Device: 16 Function: 0 Offset: C4h			
Bit	Attr	Default	Description
31:21	RO	0	<i>Reserved</i>
20	RWDS	0	L1 enable Bit is ANDed with the parameter exchanged value for L1 to determine if the link may enter L1. 0 = Disable 1 = Enable
19:0	RO	0	<i>Reserved</i>



3.7.1.5 QPI[0]LCRDC—Intel® QuickPath Interconnect Link Credit Control

Registers controls what credits are defined for each message class on VNO and VNA. These credits are made visible on Intel QuickPath Interconnect during the initialization phase of the link layer. Incorrect programming can result in overflow of the receive queue. When returning credits on Intel QuickPath Interconnect this register is used in conjunction with the Intel QuickPath Interconnect standard register QPI[0]LCL—Intel QuickPath Interconnect Link Control to determine how many credits are returned.

This value is captured and used by the Link Layer when exiting the parameter exchange. This state is referred to as “Begin Normal Operation.”

Register: QPI[0]LCRDC Device: 16 Function: 0 Offset: F8h			
Bit	Attr	Default	Description
31	RV	0	<i>Reserved</i>
30:28	RV	0h	<i>Reserved</i>
27	RV	0	<i>Reserved</i>
26:24	RWDS	1/2h	VNO - NCB credits Allowed values = 0–7 credits
23	RV	0	<i>Reserved</i>
22:20	RWDS	1/2h	VNO - NCS credits Allowed values = 0–7 credits
19	RV	0	<i>Reserved</i>
18:16	RWDS	1/2h	VNO - NDR credits With Isoc enabled this value is expected to be set at 3 to ensure QoS with processor. Allowed values = 0–7 credits
15	RV	0	<i>Reserved</i>
14:12	RWDS	1/2h	VNO - DRS credits With Isoc enabled this value is expected to be set at 4 to ensure QoS with processor. Allowed values = 0–7 credits
11	RV	0	<i>Reserved</i>
10:8	RWDS	0/2h	VNO - Snp credits Allowed values = 0–7 credits Snp credits are only needed for debug mode only. This should be set to 0 for normal operation. It can be changed to 1 for debug mode.
7	RV	0	<i>Reserved</i>
6:0	RWDS	66/4Ah	VNA credits Default is set to 102 (66h), which allows for 1 VNO credit per message class to be assigned with standard headers. 0 –127 credits Additional modifiers on VNA credits. If VNO Snp Credits is set to 1, this must be set to one less credit. If VNO DRS credits are set to the recommended isoc value (4), this should be set to 33 less credits.



3.7.2 Intel® QuickPath Interconnect Routing & Protocol Layer Registers

Table 3-21. CSR Intel® QuickPath Interconnect Routing Layer, Protocol (Device 16, Function 1)

DID	VID	00h		80h
PCISTS	PCICMD	04h		84h
CCR	RID	08h		88h
HDR	CLS	0Ch		8Ch
		10h		90h
		14h		94h
		18h		98h
		1Ch		9Ch
		20h		A0h
		24h		A4h
		28h	A8h	
SID	SVID	2Ch		ACh
		30h		B0h
	CAPPTR ¹	34h		B4h
	QPIPRDLTO	38h	QPIPSOCRES	B8h
	INTP	INTL	3Ch	BCh
				C0h
				C4h
				C8h
				CCh
QPIPCTRL0		4Ch		D0h
		50h		D4h
		54h		D8h
		58h		DCh
		5Ch		E0h
		60h		E4h
		64h		E8h
		68h		ECh
		6Ch		F0h
		70h		F4h
		74h		F8h
		78h		FCh
		7Ch		

Notes:

1. CAPPTR points to the first capability block

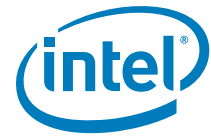

3.7.2.1 QPIPCTRL0—Intel® QuickPath Interconnect Protocol Control 0

Register can only be modified under system quiescence. All RWL bits are locked with the lock1 bit.

Register: QPIPCTRL0 Device: 16 Function: 1 Offset: 4Ch			
Bit	Attr	Default	Description
31:30	RWL	0	VC1 Priority When Isoc is enabled this value should is expected to be set as Critical. 00 = Standard 01 = Reserved 10 = High 11 = Critical (recommended when isoc enabled)
29:28	RWL	0	VCp Priority When Isoc is enabled this value should is expected to be set as High ('10). 00 = Standard 01 = Reserved 10 = High (recommended when isoc enabled) 11 = Critical
27:0	RWL	0	<i>Reserved</i>

3.7.2.2 QPIPISOCRES—Intel® QuickPath Interconnect Protocol Isochronous Reservation

Controls how TID are allocated to for Isochronous requests. Values applies across all TID allocation pools for a given Intel QuickPath Interconnect port.

Register modified only under system quiescence.

Register: QPIPISOCRES Device: 16 Function: 1 Offset: B8h			
Bit	Attr	Default	Description
31:17	RV	0	<i>Reserved</i>
16	RW	1	Isoc Enabled When set the VCp and VC1 Isoc flows are enabled on Intel QuickPath Interconnect. It is required when this is enabled that the "VC1 Maximum" and the "VCp Maximum" values be non-zero.
15:12	RW	0	VC1 Reserved Number of TIDs that are reserved for VC1 (Azalia) Traffic. The value must be less then "MaxRequest minus the Reserved for High priority". Should be set no greater than the "VC1 Maximum" value. 0-7 = Invalid values >7 = Reserved Recommend setting (VC1) = 3



Register: QPIPISOCRES Device: 16 Function: 1 Offset: B8h			
Bit	Attr	Default	Description
11:8	RW	0	VC1 Maximum Maximum tags that can be used for VC1 (Azalia) Traffic. Value should not be set greater than MaxRequests. It is required that "Pool Index" in QPI[0]PORB—QPI[0] Protocol Outgoing Request Buffer be disabled when Isoc traffic is enabled. When Isoc is enabled, this value must be set to >0. 0–7 = Maximum TIDs pending on Intel QuickPath Interconnect with critical priority set. >7 = Reserved Recommend setting (VC1 max) = 4
7:4	RW	0	VCp Reserved Number of TIDs that are reserved for VCp (legacy Isoc) Traffic. The value must be less than "MaxRequest minus the Reserved for Critical priority". Should be set no greater than the "VCp Maximum" value. 0–7 = Invalid values >7 = reserved Recommend setting (VCp) = 2
3:0	RW	0	VCp Maximum Maximum tags that can be used for VCp (legacy Isoc) Traffic. Value should not be set greater than MaxRequests. It is required that "Pool Index" in QPI[0]PORB—QPI[0] Protocol Outgoing Request Buffer be disabled when Isoc traffic is enabled. When Isoc is enabled this value must be set to >0. 0–7 = Maximum TIDs pending on Intel QuickPath Interconnect with critical priority set. >7 = Reserved Recommend setting (VCp max) = 4

3.7.2.3 CAPHDRH—PCI Express® Capability Header High Register

Capability header (capability ID) for this extended function.

Device: 16 Function: 1 Offset: 100h			
Bit	Attr	Default	Description
31:0	RO	000Bh	CAPIDH 000Bh is the Capability ID for vendor specific

§

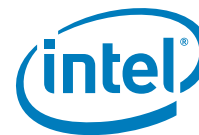

4 Processor Uncore Configuration Registers

The processor supports PCI configuration space accesses using the mechanism denoted as Configuration Mechanism in the PCI specification as defined in the latest revision of the *PCI Local Bus Specification*, as well as the PCI Express* enhanced configuration mechanism as specified in the latest revision of the *PCI Express Base Specification*. All the registers are organized by bus, device, function, and so forth, as defined in the *PCI Express Base Specification*. All processor registers appear on the PCI bus assigned for the processor socket. Bus number is derived by the max bus range setting and processor socket number. All multi-byte numeric fields use “little-endian” ordering (that is, lower addresses contain the least significant parts of the field).

4.1 Processor Uncore Configuration Structure (PCI Bus — FFh)

The processor Uncore contains the following PCI devices within a single, physical component. The configuration registers for these devices are mapped as devices residing on the PCI bus assigned for the processor socket. Bus number is derived by the max bus range setting and processor socket number.

- **Device 0** — Generic processor non-core. Device 0, Function 0 contains the generic non-core configuration registers for the processor and resides at DID (Device ID) of 2C50-7h. Device 0, Function 1 contains the System Address Decode registers and resides at DID of 2C81h.
- **Device 2** — Intel QuickPath Interconnect. Device 2, Function 0 contains the Intel QuickPath Interconnect configuration registers for Intel QuickPath Interconnect Link 0 and resides at DID of 2C90h. Device 2, Function 1 contains the frequency control layer registers for Intel QuickPath Interconnect Link 0 and resides at DID of 2C91h.
- **Device 3** — Integrated Memory Controller. Device 3, Function 0 contains the general registers for the Integrated Memory Controller and resides at DID of 2C98h. Device 3, Function 1 contains the Target Address Decode registers for the Integrated Memory Controller and resides at DID of 2C99h. Device 3, Function 4 contains the test registers for the Integrated Memory Controller and resides at DID of 2C9Ch.
- **Device 4** — Integrated Memory Controller Channel 0. Device 4, Function 0 contains the control registers for Integrated Memory Controller Channel 0 and resides at DID of 2CA0h. Device 4, Function 1 contains the address registers for Integrated Memory Controller Channel 0 and resides at DID of 2CA1h. Device 4, Function 2 contains the rank registers for Integrated Memory Controller Channel 0 and resides at DID of 2CA2h. Device 4, Function 3 contains the thermal control registers for Integrated Memory Controller Channel 0 and resides at DID of 2CA3h.
- **Device 5** — Integrated Memory Controller Channel 1. Device 5, Function 0 contains the control registers for Integrated Memory Controller Channel 1 and resides at DID of 2CA8h. Device 5, Function 1 contains the address registers for Integrated Memory Controller Channel 1 and resides at DID of 2CA9h. Device 5, Function 2 contains the rank registers for Integrated Memory Controller Channel 1 and resides at DID of 2CAAh. Device 5, Function 3 contains the thermal control registers for Integrated Memory Controller Channel 1 and resides at DID of 2CABh.

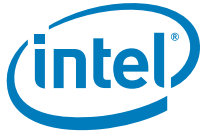

4.2 Device Mapping

Each component in the processor is uniquely identified by a PCI bus address consisting of Bus Number, Device Number and Function Number. Device configuration is based on the PCI Type 0 configuration conventions. All processor registers appear on the PCI bus assigned for the processor socket. Bus number is derived by the max bus range setting and processor socket number.

Table 4-1. Functions Specifically Handled by the Processor

Component	Register Group	DID	Device	Function
Processor	Intel QuickPath Architecture Generic Non-core Registers	2C51h	0	0
	Intel QuickPath Architecture System Address Decoder	2C81h		1
	Intel QuickPath Interconnect Link 0	2C90h	2	0
	Intel QuickPath Interconnect Physical 0	2C91h		1
	Integrated Memory Controller Registers	2C98h	3	0
	Integrated Memory Controller Target Address Decoder	2C99h		1
	Integrated Memory Controller Test Registers	2C9Ch		4
	Integrated Memory Controller Channel 0 Control	2CA0h	4	0
	Integrated Memory Controller Channel 0 Address	2CA1h		1
	Integrated Memory Controller Channel 0 Rank	2CA2h		2
	Integrated Memory Controller Channel 0 Thermal Control	2CA3h		3
	Integrated Memory Controller Channel 1 Control	2CA8h	5	0
	Integrated Memory Controller Channel 1 Address	2CA9h		1
	Integrated Memory Controller Channel 1 Rank	2CAAh		2
	Integrated Memory Controller Channel 1 Thermal Control	2CABh		3



4.3 Detailed Configuration Space Maps

Table 4-2. Device 0, Function 0 — Generic Non-core Registers

DID	VID	00h		80h
PCISTS	PCICMD	04h		84h
CCR	RID	08h		88h
HDR		0Ch		8Ch
		10h		90h
		14h		94h
		18h		98h
		1Ch		9Ch
		20h		A0h
		24h		A4h
		28h		A8h
SID	SVID	2Ch		ACh
		30h		B0h
		34h		B4h
		38h		B8h
		3Ch		BCh
		40h		C0h
		44h		C4h
		48h		C8h
		4Ch		CCh
		50h		D0h
		54h		D4h
		58h		D8h
		5Ch		DCh
		60h		E0h
		64h		E4h
		68h		E8h
		6Ch		ECh
		70h		F0h
		74h		F4h
		78h		F8h
		7Ch		FCh

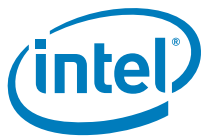

Table 4-3. Device 0, Function 1 — System Address Decoder Registers

DID	VID	00h	SAD_DRAM_RULE_0	80h
PCISTS	PCICMD	04h	SAD_DRAM_RULE_1	84h
CCR	RID	08h	SAD_DRAM_RULE_2	88h
HDR		0Ch	SAD_DRAM_RULE_3	8Ch
		10h	SAD_DRAM_RULE_4	90h
		14h	SAD_DRAM_RULE_5	94h
		18h	SAD_DRAM_RULE_6	98h
		1Ch	SAD_DRAM_RULE_7	9Ch
		20h		A0h
		24h		A4h
		28h		A8h
SID	SVID	2Ch		ACh
		30h		B0h
		34h		B4h
		38h		B8h
		3Ch		BCh
SAD_PAM0123		40h	SAD_INTERLEAVE_LIST_0	C0h
SAD_PAM456		44h	SAD_INTERLEAVE_LIST_1	C4h
SAD_HEN		48h	SAD_INTERLEAVE_LIST_2	C8h
SAD_SMRAM		4Ch	SAD_INTERLEAVE_LIST_3	CCh
SAD_PCIEXBAR		50h	SAD_INTERLEAVE_LIST_4	D0h
		54h	SAD_INTERLEAVE_LIST_5	D4h
SAD_TPCIEXBAR		58h	SAD_INTERLEAVE_LIST_6	D8h
		5Ch	SAD_INTERLEAVE_LIST_7	DCh
SAD_MCSEG_BASE		60h		E0h
		64h		E4h
SAD_MCSEG_MASK		68h		E8h
		6Ch		ECh
SAD_MESEG_BASE		70h		F0h
		74h		F4h
SAD_MESEG_MASK		78h		F8h
		7Ch		FCh



Table 4-4. Device 2, Function 0 — Intel® QuickPath Interconnect Link 0 Registers

DID	VID	00h		80h	
PCISTS	PCICMD	04h		84h	
CCR		RID		08h	88h
HDR				0Ch	8Ch
				10h	90h
				14h	94h
				18h	98h
				1Ch	9Ch
				20h	A0h
				24h	A4h
				28h	A8h
SID	SVID	2Ch			ACh
				30h	B0h
				34h	B4h
				38h	B8h
				3Ch	BCh
				40h	C0h
				44h	C4h
QPI_QPILCL_L0				48h	C8h
				4Ch	CCh
				50h	D0h
				54h	D4h
				58h	D8h
				5Ch	DCh
				60h	E0h
				64h	E4h
				68h	E8h
				6Ch	ECh
				70h	F0h
				74h	F4h
				78h	F8h
				7Ch	FCh



Table 4-5. Device 2, Function 1 — Intel® QuickPath Interconnect Physical 0 Registers

DID	VID	00h		80h
PCISTS	PCICMD	04h		84h
CCR	RID	08h		88h
HDR		0Ch		8Ch
		10h		90h
		14h		94h
		18h		98h
		1Ch		9Ch
		20h		A0h
		24h		A4h
		28h		A8h
SID	SVID	2Ch		ACh
		30h		B0h
		34h		B4h
		38h		B8h
		3Ch		BCh
		40h		C0h
		44h		C4h
		48h		C8h
		4Ch		CCh
		50h	D0h	
		54h	D4h	
		58h	D8h	
		5Ch	DCh	
		60h	E0h	
		64h	E4h	
		68h	E8h	
		6Ch	ECh	
		70h	F0h	
		74h	F4h	
		78h	F8h	
		7Ch	FCh	

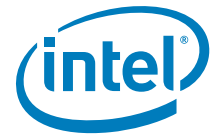

Table 4-6. Device 3, Function 0 — Integrated Memory Controller Registers

DID	VID	00h		80h
PCISTS	PCICMD	04h		84h
CCR	RID	08h		88h
HDR		0Ch		8Ch
		10h		90h
		14h		94h
		18h		98h
		1Ch		9Ch
		20h		A0h
		24h		A4h
		28h		A8h
SID	SVID	2Ch		ACH
		30h		B0h
		34h		B4h
		38h		B8h
		3Ch		BCh
		40h		C0h
		44h		C4h
MC_CONTROL		48h		C8h
MC_STATUS		4Ch		CCh
MC_SMI_DIMM_ERROR_STATUS		50h		D0h
MC_SMI_CNTRL		54h		D4h
		58h	D8h	
MC_RESET_CONTROL		5Ch	DCh	
MC_CHANNEL_MAPPER		60h	E0h	
MC_MAX_DOD		64h	E4h	
MC_CFG_LOCK		68h	E8h	
		6Ch	ECh	
MC_RD_CRDT_INIT		70h	F0h	
MC_CRDT_WR_THLD		74h	F4h	
		78h	F8h	
		7Ch	FCh	



Table 4-7. Device 3, Function 1 — Target Address Decoder Registers

DID	VID	00h	TAD_DRAM_RULE_0	80h
PCISTS	PCICMD	04h	TAD_DRAM_RULE_1	84h
CCR	RID	08h	TAD_DRAM_RULE_2	88h
HDR		0Ch	TAD_DRAM_RULE_3	8Ch
		10h	TAD_DRAM_RULE_4	90h
		14h	TAD_DRAM_RULE_5	94h
		18h	TAD_DRAM_RULE_6	98h
		1Ch	TAD_DRAM_RULE_7	9Ch
		20h		A0h
		24h		A4h
		28h		A8h
SID	SVID	2Ch		ACh
		30h		B0h
		34h		B4h
		38h		B8h
		3Ch		BCh
		40h	TAD_INTERLEAVE_LIST_0	C0h
		44h	TAD_INTERLEAVE_LIST_1	C4h
		48h	TAD_INTERLEAVE_LIST_2	C8h
		4Ch	TAD_INTERLEAVE_LIST_3	CCh
		50h	TAD_INTERLEAVE_LIST_4	D0h
		54h	TAD_INTERLEAVE_LIST_5	D4h
		58h	TAD_INTERLEAVE_LIST_6	D8h
		5Ch	TAD_INTERLEAVE_LIST_7	DCh
		60h		E0h
		64h		E4h
		68h		E8h
		6Ch		ECh
		70h		F0h
		74h		F4h
		78h		F8h
		7Ch		FCh

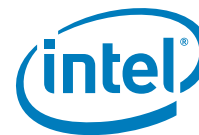

Table 4-8. Device 3, Function 2 — Memory Controller Test Registers

DID	VID	00h		80h
PCISTS	PCICMD	04h		84h
CCR		RID	08h	88h
HDR			0Ch	8Ch
			10h	90h
			14h	94h
			18h	98h
			1Ch	9Ch
			20h	A0h
			24h	A4h
			28h	A8h
SID	SVID		2Ch	ACh
			30h	B0h
			34h	B4h
			38h	B8h
			3Ch	BCh
			40h	C0h
			44h	C4h
			48h	C8h
			4Ch	CCh
			50h	D0h
			54h	D4h
			58h	D8h
			5Ch	DCh
			60h	E0h
			64h	E4h
			68h	E8h
			6Ch	ECh
	70h	F0h		
	74h	F4h		
	78h	F8h		
	7Ch	FCh		

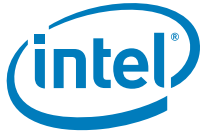

Table 4-9. Device 3, Function 4 — Integrated Memory Controller Test Registers

DID	VID	00h	MC_TEST_PH_PIS	80h
PCISTS	PCICMD	04h		84h
CCR	RID	08h		88h
HDR		0Ch		8Ch
		10h		90h
		14h		94h
		18h		98h
		1Ch		9Ch
		20h		A0h
		24h		A4h
		28h	MC_TEST_PAT_GCTR	A8h
SID	SVID	2Ch		ACH
		30h	MC_TEST_PAT_BA	B0h
		34h		B4h
		38h		B8h
		3Ch	MC_TEST_PAT_IS	BCh
		40h	MC_TEST_PAT_DCD	C0h
		44h		C4h
		48h		C8h
		4Ch		CCh
MC_DIMM_CLK_RATIO_STATUS		50h		D0h
MC_DIMM_CLK_RATIO		54h		D4h
		58h		D8h
MC_TEST_LTRCON		5Ch		DCh
		60h		E0h
		64h		E4h
		68h		E8h
MC_TEST_PH_CTR		6Ch		ECh
		70h		F0h
		74h		F4h
		78h	MC_TEST_EP_SCCTL	F8h
		7Ch	MC_TEST_EP_SCD	FCh

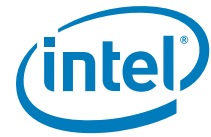

Table 4-10. Device 4, Function 0 — Integrated Memory Controller Channel 0 Control Registers

DID	VID	00h	MC_CHANNEL_0_RANK_TIMING_A	80h
PCISTS	PCICMD	04h	MC_CHANNEL_0_RANK_TIMING_B	84h
CCR		RID	MC_CHANNEL_0_BANK_TIMING	88h
HDR			MC_CHANNEL_0_REFRESH_TIMING	8Ch
		10h	MC_CHANNEL_0_CKE_TIMING	90h
		14h	MC_CHANNEL_0_ZQ_TIMING	94h
		18h	MC_CHANNEL_0_RCOMP_PARAMS	98h
		1Ch	MC_CHANNEL_0_ODT_PARAMS1	9Ch
		20h	MC_CHANNEL_0_ODT_PARAMS2	A0h
		24h	MC_CHANNEL_0_ODT_MATRIX_RANK_0_3_RD	A4h
		28h	MC_CHANNEL_0_ODT_MATRIX_RANK_4_7_RD	A8h
		SID	SVID	2Ch
		30h	MC_CHANNEL_0_ODT_MATRIX_RANK_4_7_WR	B0h
		34h	MC_CHANNEL_0_WAQ_PARAMS	B4h
		38h	MC_CHANNEL_0_SCHEDULER_PARAMS	B8h
		3Ch	MC_CHANNEL_0_MAINTENANCE_OPS	BCh
		40h	MC_CHANNEL_0_TX_BG_SETTINGS	C0h
		44h		C4h
		48h	MC_CHANNEL_0_RX_BGF_SETTINGS	C8h
		4Ch	MC_CHANNEL_0_EW_BGF_SETTINGS	CCh
MC_CHANNEL_0_DIMM_RESET_CMD		50h	MC_CHANNEL_0_EW_BGF_OFFSET_SETTINGS	D0h
MC_CHANNEL_0_DIMM_INIT_CMD		54h	MC_CHANNEL_0_ROUND_TRIP_LATENCY	D4h
MC_CHANNEL_0_DIMM_INIT_PARAMS		58h	MC_CHANNEL_0_PAGETABLE_PARAMS1	D8h
MC_CHANNEL_0_DIMM_INIT_STATUS		5Ch	MC_CHANNEL_0_PAGETABLE_PARAMS2	DCh
MC_CHANNEL_0_DDR3CMD		60h	MC_TX_BG_CMD_DATA_RATIO_SETTINGS_CHO	E0h
		64h	MC_TX_BG_CMD_OFFSET_SETTINGS_CHO	E4h
MC_CHANNEL_0_REFRESH_THROTTLE_SUPPORT		68h	MC_TX_BG_DATA_OFFSET_SETTINGS_CHO	E8h
		6Ch		ECh
MC_CHANNEL_0_MRS_VALUE_0_1		70h	MC_CHANNEL_0_ADDR_MATCH	F0h
MC_CHANNEL_0_MRS_VALUE_2		74h		F4h
		78h		F8h
MC_CHANNEL_0_RANK_PRESENT		7Ch		FCh



Table 4-11. Device 4, Function 1 — Integrated Memory Controller Channel 0 Address Registers

DID	VID	00h	MC_SAG_CH0_0	80h
PCISTS	PCICMD	04h	MC_SAG_CH0_1	84h
CCR		08h	MC_SAG_CH0_2	88h
HDR		0Ch	MC_SAG_CH0_3	8Ch
		10h	MC_SAG_CH0_4	90h
		14h	MC_SAG_CH0_5	94h
		18h	MC_SAG_CH0_6	98h
		1Ch	MC_SAG_CH0_7	9Ch
		20h		A0h
		24h		A4h
		28h		A8h
SID	SVID	2Ch		ACh
		30h		B0h
		34h		B4h
		38h		B8h
		3Ch		BCh
		40h		C0h
		44h		C4h
MC_DOD_CH0_0		48h		C8h
MC_DOD_CH0_1		4Ch		CCh
		50h		D0h
		54h		D4h
		58h		D8h
		5Ch		DCh
		60h		E0h
		64h		E4h
		68h		E8h
		6Ch		ECh
		70h		F0h
		74h		F4h
		78h		F8h
7Ch		FCh		

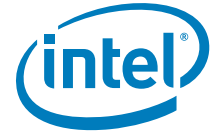

Table 4-12. Device 4, Function 2 — Integrated Memory Controller Channel 0 Rank Registers

DID	VID	00h	MC_RIR_WAY_CHO_0	80h
PCISTS	PCICMD	04h	MC_RIR_WAY_CHO_1	84h
CCR		RID	08h	MC_RIR_WAY_CHO_2
HDR			0Ch	MC_RIR_WAY_CHO_3
			10h	MC_RIR_WAY_CHO_4
			14h	MC_RIR_WAY_CHO_5
			18h	MC_RIR_WAY_CHO_6
			1Ch	MC_RIR_WAY_CHO_7
			20h	MC_RIR_WAY_CHO_8
			24h	MC_RIR_WAY_CHO_9
			28h	MC_RIR_WAY_CHO_10
SID	SVID		2Ch	MC_RIR_WAY_CHO_11
			30h	MC_RIR_WAY_CHO_12
			34h	MC_RIR_WAY_CHO_13
			38h	MC_RIR_WAY_CHO_14
			3Ch	MC_RIR_WAY_CHO_15
MC_RIR_LIMIT_CHO_0			40h	MC_RIR_WAY_CHO_16
MC_RIR_LIMIT_CHO_1			44h	MC_RIR_WAY_CHO_17
MC_RIR_LIMIT_CHO_2			48h	MC_RIR_WAY_CHO_18
MC_RIR_LIMIT_CHO_3			4Ch	MC_RIR_WAY_CHO_19
MC_RIR_LIMIT_CHO_4			50h	MC_RIR_WAY_CHO_20
MC_RIR_LIMIT_CHO_5			54h	MC_RIR_WAY_CHO_21
MC_RIR_LIMIT_CHO_6			58h	MC_RIR_WAY_CHO_22
MC_RIR_LIMIT_CHO_7			5Ch	MC_RIR_WAY_CHO_23
			60h	MC_RIR_WAY_CHO_24
			64h	MC_RIR_WAY_CHO_25
			68h	MC_RIR_WAY_CHO_26
			6Ch	MC_RIR_WAY_CHO_27
			70h	MC_RIR_WAY_CHO_28
			74h	MC_RIR_WAY_CHO_29
			78h	MC_RIR_WAY_CHO_30
			7Ch	MC_RIR_WAY_CHO_31



Table 4-13. Device 4, Function 3 — Integrated Memory Controller Channel 0 Thermal Control Registers

DID	VID	00h	MC_COOLING_COEF0	80h
PCISTS	PCICMD	04h	MC_CLOSED_LOOP0	84h
CCR	RID	08h	MC_THROTTLE_OFFSET0	88h
HDR		0Ch		8Ch
		10h		90h
		14h		94h
		18h	MC_RANK_VIRTUAL_TEMPO	98h
		1Ch	MC_DDR_THERM_COMMAND0	9Ch
		20h		A0h
		24h	MC_DDR_THERM_STATUS0	A4h
		28h		A8h
SID	SVID	2Ch		ACh
		30h		B0h
		34h		B4h
		38h		B8h
		3Ch		BCh
		40h		C0h
		44h		C4h
		48h	MC_THERMAL_CONTROLO	C8h
		4Ch	MC_THERMAL_STATUS0	CCh
		50h	MC_THERMAL_DEFEATURE0	D0h
		54h		D4h
		58h		D8h
		5Ch		DCh
		60h	MC_THERMAL_PARAMS_A0	E0h
		64h	MC_THERMAL_PARAMS_B0	E4h
		68h		E8h
		6Ch		ECh
		70h		F0h
		74h		F4h
		78h		F8h
		7Ch		FCh

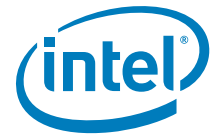

Table 4-14. Device 5, Function 0 — Integrated Memory Controller Channel 1 Control Registers

DID	VID	00h	MC_CHANNEL_1_RANK_TIMING_A	80h
PCISTS	PCICMD	04h	MC_CHANNEL_1_RANK_TIMING_B	84h
CCR		08h	MC_CHANNEL_1_BANK_TIMING	88h
HDR		0Ch	MC_CHANNEL_1_REFRESH_TIMING	8Ch
		10h	MC_CHANNEL_1_CKE_TIMING	90h
		14h	MC_CHANNEL_1_ZQ_TIMING	94h
		18h	MC_CHANNEL_1_RCOMP_PARAMS	98h
		1Ch	MC_CHANNEL_1_ODT_PARAMS1	9Ch
		20h	MC_CHANNEL_1_ODT_PARAMS2	A0h
		24h	MC_CHANNEL_1_ODT_MATRIX_RANK_0_3_RD	A4h
		28h	MC_CHANNEL_1_ODT_MATRIX_RANK_4_7_RD	A8h
		SID	SVID	2Ch
		30h	MC_CHANNEL_1_ODT_MATRIX_RANK_4_7_WR	B0h
		34h	MC_CHANNEL_1_WAQ_PARAMS	B4h
		38h	MC_CHANNEL_1_SCHEDULER_PARAMS	B8h
		3Ch	MC_CHANNEL_1_MAINTENANCE_OPS	BCh
		40h	MC_CHANNEL_1_TX_BG_SETTINGS	C0h
		44h		C4h
		48h	MC_CHANNEL_1_RX_BGF_SETTINGS	C8h
		4Ch	MC_CHANNEL_1_EW_BGF_SETTINGS	CCh
MC_CHANNEL_1_DIMM_RESET_CMD		50h	MC_CHANNEL_1_EW_BGF_OFFSET_SETTINGS	D0h
MC_CHANNEL_1_DIMM_INIT_CMD		54h	MC_CHANNEL_1_ROUND_TRIP_LATENCY	D4h
MC_CHANNEL_1_DIMM_INIT_PARAMS		58h	MC_CHANNEL_1_PAGETABLE_PARAMS1	D8h
MC_CHANNEL_1_DIMM_INIT_STATUS		5Ch	MC_CHANNEL_1_PAGETABLE_PARAMS2	DCh
MC_CHANNEL_1_DDR3CMD		60h	MC_TX_BG_CMD_DATA_RATIO_SETTINGS_CH1	E0h
		64h	MC_TX_BG_CMD_OFFSET_SETTINGS_CH1	E4h
MC_CHANNEL_1_REFRESH_THROTTLE_SUPPORT		68h	MC_TX_BG_DATA_OFFSET_SETTINGS_CH1	E8h
		6Ch		ECh
MC_CHANNEL_1_MRS_VALUE_0_1		70h		F0h
MC_CHANNEL_1_MRS_VALUE_2		74h		F4h
		78h		F8h
MC_CHANNEL_1_RANK_PRESENT		7Ch		FCh



Table 4-15. Device 5, Function 1 — Integrated Memory Controller Channel 1 Address Registers

DID	VID	00h	MC_SAG_CH1_0	80h
PCISTS	PCICMD	04h	MC_SAG_CH1_1	84h
CCR		08h	MC_SAG_CH1_2	88h
HDR		0Ch	MC_SAG_CH1_3	8Ch
		10h	MC_SAG_CH1_4	90h
		14h	MC_SAG_CH1_5	94h
		18h	MC_SAG_CH1_6	98h
		1Ch	MC_SAG_CH1_7	9Ch
		20h		A0h
		24h		A4h
		28h		A8h
SID	SVID	2Ch		ACh
		30h		B0h
		34h		B4h
		38h		B8h
		3Ch		BCh
		40h		C0h
		44h		C4h
MC_DOD_CH1_0		48h		C8h
MC_DOD_CH1_1		4Ch		CCh
		50h		D0h
		54h		D4h
		58h		D8h
		5Ch		DCh
		60h		E0h
		64h		E4h
		68h		E8h
		6Ch		ECh
		70h		F0h
		74h		F4h
		78h		F8h
		7Ch		FCh

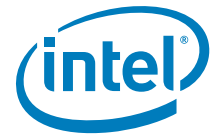

Table 4-16. Device 5, Function 2 — Integrated Memory Controller Channel 1 Rank Registers

DID	VID	00h	MC_RIR_WAY_CH1_0	80h
PCISTS	PCICMD	04h	MC_RIR_WAY_CH1_1	84h
CCR		08h	MC_RIR_WAY_CH1_2	88h
HDR		0Ch	MC_RIR_WAY_CH1_3	8Ch
		10h	MC_RIR_WAY_CH1_4	90h
		14h	MC_RIR_WAY_CH1_5	94h
		18h	MC_RIR_WAY_CH1_6	98h
		1Ch	MC_RIR_WAY_CH1_7	9Ch
		20h	MC_RIR_WAY_CH1_8	A0h
		24h	MC_RIR_WAY_CH1_9	A4h
		28h	MC_RIR_WAY_CH1_10	A8h
SID	SVID	2Ch	MC_RIR_WAY_CH1_11	ACH
		30h	MC_RIR_WAY_CH1_12	B0h
		34h	MC_RIR_WAY_CH1_13	B4h
		38h	MC_RIR_WAY_CH1_14	B8h
		3Ch	MC_RIR_WAY_CH1_15	BCh
MC_RIR_LIMIT_CH1_0		40h	MC_RIR_WAY_CH1_16	C0h
MC_RIR_LIMIT_CH1_1		44h	MC_RIR_WAY_CH1_17	C4h
MC_RIR_LIMIT_CH1_2		48h	MC_RIR_WAY_CH1_18	C8h
MC_RIR_LIMIT_CH1_3		4Ch	MC_RIR_WAY_CH1_19	CCh
MC_RIR_LIMIT_CH1_4		50h	MC_RIR_WAY_CH1_20	D0h
MC_RIR_LIMIT_CH1_5		54h	MC_RIR_WAY_CH1_21	D4h
MC_RIR_LIMIT_CH1_6		58h	MC_RIR_WAY_CH1_22	D8h
MC_RIR_LIMIT_CH1_7		5Ch	MC_RIR_WAY_CH1_23	DCh
		60h	MC_RIR_WAY_CH1_24	E0h
		64h	MC_RIR_WAY_CH1_25	E4h
		68h	MC_RIR_WAY_CH1_26	E8h
		6Ch	MC_RIR_WAY_CH1_27	ECh
		70h	MC_RIR_WAY_CH1_28	F0h
		74h	MC_RIR_WAY_CH1_29	F4h
		78h	MC_RIR_WAY_CH1_30	F8h
		7Ch	MC_RIR_WAY_CH1_31	FCh

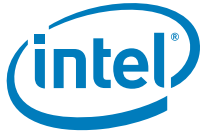
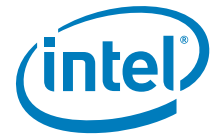

Table 4-17. Device 5, Function 3 — Integrated Memory Controller Channel 1 Thermal Control Registers

DID	VID	00h	MC_COOLING_COEF1	80h
PCISTS	PCICMD	04h	MC_CLOSED_LOOP1	84h
CCR	RID	08h	MC_THROTTLE_OFFSET1	88h
HDR		0Ch		8Ch
		10h		90h
		14h		94h
		18h	MC_RANK_VIRTUAL_TEMP1	98h
		1Ch		9Ch
		20h	MC_DDR_THERM_COMMAND1	A0h
		24h	MC_DDR_THERM_STATUS1	A4h
		28h		A8h
SID	SVID	2Ch		ACh
		30h		B0h
		34h		B4h
		38h		B8h
		3Ch		BCh
		40h		C0h
		44h		C4h
		48h	MC_THERMAL_CONTROL1	C8h
		4Ch	MC_THERMAL_STATUS1	CCh
		50h	MC_THERMAL_DEFEATURE1	D0h
		54h		D4h
		58h		D8h
		5Ch		DCh
		60h	MC_THERMAL_PARAMS_A1	E0h
		64h	MC_THERMAL_PARAMS_B1	E4h
		68h		E8h
		6Ch		ECh
		70h		F0h
		74h		F4h
		78h		F8h
		7Ch		FCh



4.4 PCI Standard Registers

These registers appear in every function for every device.

4.4.1 VID—Vendor Identification Register

The VID Register contains the vendor identification number. This 16-bit register, combined with the Device Identification Register uniquely identifies the manufacturer of the function within the processor. Writes to this register have no effect.

Device: 0 Function: 0, 1 Offset: 00h			
Device: 2 Function: 0, 1 Offset: 00h			
Device: 3 Function: 0, 1, 4 Offset: 00h			
Device: 4, 5 Function: 0–3 Offset: 00h			
Bit	Attr	Default	Description
15:0	RO	8086h	Vendor Identification Number The value assigned to Intel.

4.4.2 DID—Device Identification Register

This 16-bit register combined with the Vendor Identification register uniquely identifies the Function within the processor. Writes to this register have no effect. See [Table 4-1](#) for the DID of each processor function.

Device: 0 Function: 0, 1 Offset: 02h			
Device: 2 Function: 0, 1 Offset: 02h			
Device: 3 Function: 0, 1, 4 Offset: 02h			
Device: 4, 5 Function: 0–3 Offset: 02h			
Bit	Attr	Default	Description
15:0	RO	*See Table 4-1	Device Identification Number Identifies each function of the processor.

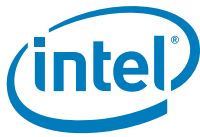

4.4.3 RID—Revision Identification Register

This register contains the revision number of the processor. The Revision ID (RID) is a traditional 8-bit Read Only (RO) register located at offset 08h in the standard PCI header of every PCI/PCI Express compatible device and function.

Previously, a new value for RID was assigned for Intel chipsets for every stepping. There is a need to provide an alternative value for software compatibility when a particular driver or patch unique to that stepping or an earlier stepping is required, for instance, to prevent Windows software from flagging differences in RID during device enumeration. The solution is to implement a mechanism to read one of two possible values from the RID register:

1. **Stepping Revision ID (SRID):** This is the default power on value for mask/metal steppings
2. **Compatible Revision ID (CRID):** The CRID functionality gives BIOS the flexibility to load OS drivers optimized for a previous revision of the silicon instead of the current revision of the silicon in order to reduce drivers updates and minimize changes to the OS image for minor optimizations to the silicon for yield improvement, or feature enhancement reasons that do not negatively impact the OS driver functionality.

Reading the RID in the processor returns either the SRID or CRID depending on the state of a register select flip-flop. Following reset, the register select flip flop is reset and the SRID is returned when the RID is read at offset 08h. The SRID value reflects the actual product stepping. To select the CRID value, BIOS/configuration software writes a key value of 69h to Bus 0, Device 0, Function 0 (DMI device) of the processor's RID register at offset 08h. This sets the SRID/CRID register select flip-flop and causes the CRID to be returned when the RID is read at offset 08h.

The RID register in the DMI device (Bus 0 device 0 Function 0) is a "write-once" sticky register and gets locked after the first write. This causes the CRID to be returned on all subsequent RID register reads. Software should read and save all device SRID values by reading processor device RID registers before setting the SRID/CRID register select flip flop. The RID values for all devices and functions in the processor are controlled by the SRID/CRID register select flip flop, thus writing the key value (69h) to the RID register in Bus 0, Device 0, Function 0 sets all processor device RID registers to return the CRID. Writing to the RID register of other devices has no effect on the SRID/CRID register select flip-flop. Only a power good reset can change the RID selection back to SRID.



Device: 0 Function: 0, 1 Offset: 08h			
Device: 2 Function: 0, 1 Offset: 08h			
Device: 3 Function: 0, 1, 4 Offset: 08h			
Device: 4, 5 Function: 0-3 Offset: 08h			
Bit	Attr	Default	Description
7:4	RO	See description	Minor Revision Steppings which required all masks be regenerated. Refer to the <i>Intel® Core™ i7-800 and i5-700 Desktop Processor Series Specification Update</i> for the value of the Revision ID Register.
3:0	RO	See description	Minor Revision Identification Number Increment for each steppings which do not require masks to be regenerated. Refer to the <i>Intel® Core™ i7-800 and i5-700 Processor Specification Update</i> for the value of the Revision ID Register.

4.4.3.1 Stepping Revision ID (SRID)

This register contains the revision number of the processor.

The SRID is a 4-bit hardwired value assigned by Intel, based on product’s stepping. The SRID is not a directly addressable PCI register. The SRID value is reflected through the RID register when appropriately addressed. The 4 bits of the SRID are reflected as the two least significant bits of the major and minor revision field respectively. See [Table 4-1](#).

4.4.3.2 Compatible Revision ID (CRID)

The CRID is an 4-bit hardwired value assigned by Intel during manufacturing process. Normally, the value assigned as the CRID will be identical to the SRID value of a previous stepping of the product with which the new product is deemed “compatible”.

The CRID is not a directly addressable PCI register. The CRID value is reflected through the RID register when appropriately addressed. The 4 bits of the CRID are reflected as the two least significant bits of the major and minor revision field respectively. See [Table 4-1](#).



4.4.4 CCR—Class Code Register

This register contains the Class Code for the device. Writes to this register have no effect.

Device: 0 Function: 0, 1 Offset: 0Eh			
Device: 2 Function: 0, 1 Offset: 0Eh			
Device: 3 Function: 0, 1, 4 Offset: 0Eh			
Device: 4, 5 Function: 0–3 Offset: 0Eh			
Bit	Attr	Default	Description
23:16	RO	06h	Base Class This field indicates the general device category. For the processor, this field is hardwired to 06h, indicating it is a "Bridge Device".
15:8	RO	0	Sub-Class This field qualifies the Base Class, providing a more detailed specification of the device function. For all devices, the default is 00h, indicating "Host Bridge".
7:0	RO	0	Register-Level Programming Interface This field identifies a specific programming interface (if any), that device independent software can use to interact with the device. There are no such interfaces defined for "Host Bridge" types, and this field is hardwired to 00h.

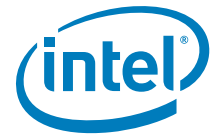

4.4.5 HDR—Header Type Register

This register identifies the header layout of the configuration space.

Device: 0 Function: 0, 1 Offset: 08h			
Device: 2 Function: 0, 1 Offset: 08h			
Device: 3 Function: 0, 1, 4 Offset: 08h			
Device: 4, 5 Function: 0–3 Offset: 08h			
Bit	Attr	Default	Description
7	RO	1	Multi-Function Device This bit selects whether this is a multi-function device, that may have alternative configuration layouts. This bit is hardwired to 1 for devices in the processor.
6:0	RO	0	Configuration Layout This field identifies the format of the configuration header layout for a PCI-to-PCI bridge from bytes 10h through 3Fh. For all devices, the default is 00h, indicating a conventional type 00h PCI header.

4.4.6 SVID—Subsystem Vendor Identification Register

This register identifies the manufacturer of the system. This 16-bit register combined with the Device Identification Register uniquely identify any PCI device.

Device: 0 Function: 0, 1 Offset: 2Ch			
Device: 2 Function: 0, 1 Offset: 2Ch			
Device: 3 Function: 0, 1, 4 Offset: 2Ch			
Device: 4, 5 Function: 0–3 Offset: 2Ch			
Bit	Attr	Default	Description
15:0	RWO	8086h	Vendor Identification Number The default value specifies Intel.

A write to any of the above registers on the processor will write to all of them.



4.4.7 SID—Subsystem Identity

This register identifies the system. It appears in every function.

Device: 0 Function: 0, 1 Offset: 2Eh			
Device: 2 Function: 0, 1 Offset: 2Eh			
Device: 3 Function: 0, 1, 4 Offset: 2Eh			
Device: 4, 5 Function: 0–3 Offset: 2Eh			
Bit	Attr	Default	Description
15:0	RWO	8086h	Subsystem Identification Number The default value specifies Intel.

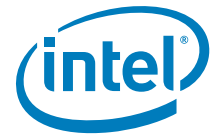

4.4.8 PCI CMD—Command Register

This register defines the PCI 3.0 compatible command register values applicable to PCI Express space.

Device: 0 Function: 0, 1 Offset: 04h			
Device: 2 Function: 0, 1 Offset: 04h			
Device: 3 Function: 0, 1, 4 Offset: 04h			
Device: 4, 5 Function: 0–3 Offset: 04h			
Bit	Attr	Default	Description
15:11	RV	0	<i>Reserved. (by PCI-SIG)</i>
10	RO	0	INTxDisable: Interrupt Disable Controls the ability of the PCI Express port to generate INTx messages. If this device does not generate interrupts, this bit is not implemented and is RO. If this device generates interrupts, this bit is RW and this bit disables the device/function from asserting INTx#. A value of 0 enables the assertion of its INTx# signal. A value of 1 disables the assertion of its INTx# signal. Legacy Interrupt mode is enabled 1 = Legacy Interrupt mode is disabled
9	RO	0	FB2B: Fast Back-to-Back Enable This bit controls whether or not the master can do fast back-to-back writes. Since this device is strictly a target this bit is not implemented. This bit is hardwired to 0. Writes to this bit position have no effect.
8	RO	0	SERRE: SERR Message Enable This bit is a global enable bit for this devices SERR messaging. This host bridge will not implement SERR messaging. This bit is hardwired to 0. Writes to this bit position have no effect. If SERR is used for error generation, then this bit must be RW and enable/disable SERR signaling.
7	RO	0	IDSELWCC: IDSEL Stepping/Wait Cycle Control Per the PCI 2.3 specification, this bit is hardwired to 0. Writes to this bit position have no effect.
6	RO	0	PERRE: Parity Error Response Enable Parity error is not implemented in this host bridge. This bit is hardwired to 0. Writes to this bit position have no effect.
5	RO	0	VGAPSE: VGA palette snoop Enable This host bridge does not implement this bit. This bit is hardwired to a 0. Writes to this bit position have no effect.
4	RO	0	MWIEN: Memory Write and Invalidate Enable This host bridge will never issue memory write and invalidate commands. This bit is therefore hardwired to 0. Writes to this bit position will have no effect.
3	RO	0	SCE: Special Cycle Enable This host bridge does not implement this bit. This bit is hardwired to a 0. Writes to this bit position will have no effect.
2	RO	1	BME: Bus Master Enable This host bridge is always enabled as a master. This bit is hardwired to a 1. Writes to this bit position have no effect.
1	RO	1	MSE: Memory Space Enable This host bridge always allows access to main memory. This bit is not implemented and is hardwired to 1. Writes to this bit position have no effect.
0	RO	0	IOAE: Access Enable This bit is not implemented in this host bridge and is hardwired to 0. Writes to this bit position have no effect.

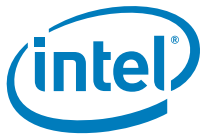

4.4.9 PCISTS—PCI Status Register

The PCI Status register is a 16-bit status register that reports the occurrence of various error events on this device's PCI interface.

Device: 0 Function: 0, 1 Offset: 06h			
Device: 2 Function: 0, 1 Offset: 06h			
Device: 3 Function: 0, 1, 4 Offset: 06h			
Device: 4, 5 Function: 0–3 Offset: 06h			
Bit	Attr	Default	Description
15	RO	0	Detect Parity Error (DPE) The host bridge does not implement this bit and it is hardwired to a 0. Writes to this bit position have no effect.
14	RO	0	Signaled System Error (SSE) This bit is set to 1 when this device generates an SERR message over the bus for any enabled error condition. If the host bridge does not signal errors using this bit, this bit is hardwired to a 0 and is read-only. Writes to this bit position have no effect.
13	RO	0	Received Master Abort Status (RMAS) This bit is set when this device generates request that receives an Unsupported Request completion packet. Software clears the bit by writing 1 to it. If this device does not receive Unsupported Request completion packets, this bit is hardwired to 0 and is read-only. Writes to this bit position have no effect.
12	RO	0	Received Target Abort Status (RTAS) This bit is set when this device generates a request that receives a Completer Abort completion packet. Software clears this bit by writing a 1 to it. If this device does not receive Completer Abort completion packets, this bit is hardwired to 0 and read-only. Writes to this bit position have no effect.
11	RO	0	Signaled Target Abort Status (STAS) This device will not generate a Target Abort completion or Special Cycle. This bit is not implemented in this device and is hardwired to a 0. Writes to this bit position have no effect.
10:9	RO	0	DEVSEL Timing (DEVT) These bits are hardwired to "00". Writes to these bit positions have no effect. This device does not physically connect to PCI bus X. These bits are set to "00" (fast decode) so that optimum DEVSEL timing for PCI bus X is not limited by this device.
8	RO	0	Master Data Parity Error Detected (DPD) PERR signaling and messaging are not implemented by this bridge, therefore this bit is hardwired to 0. Writes to this bit position have no effect.
7	RO	1	Fast Back-to-Back (FB2B) This bit is hardwired to 1. Writes to this bit position have no effect. This device is not physically connected to a PCI bus. This bit is set to 1 (indicating back-to-back capabilities) so that the optimum setting for this PCI bus is not limited by this device.
6	RO	0	<i>Reserved</i>

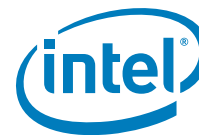

Device: 0 Function: 0, 1 Offset: 06h			
Device: 2 Function: 0, 1 Offset: 06h			
Device: 3 Function: 0, 1, 4 Offset: 06h			
Device: 4, 5 Function: 0–3 Offset: 06h			
Bit	Attr	Default	Description
5	RO	0	66-MHz Capable Does not apply to PCI Express. Must be hardwired to 0.
4	RO	1	Capability List (CLIST) This bit is hardwired to 1 to indicate to the configuration software that this device/function implements a list of new capabilities. A list of new capabilities is accessed using registers CAPPTR at the configuration address offset 34h from the start of the PCI configuration space header of this function. Register CAPPTR contains the offset pointing to the start address with configuration space of this device where the capability register resides. This bit must be set for a PCI Express device or the VSEC capability. If no capability structures are implemented, this bit is hardwired to 0.
3	RO	0	Interrupt Status If this device generates an interrupt, then this read-only bit reflects the state of the interrupt in the device/function. Only when the Interrupt Disable bit in the command register is a 0 and this Interrupt Status bit is a 1, will the device's/function's INTx# signal be asserted. Setting the Interrupt Disable bit to a 1 has no effect on the state of this bit. If this device does not generate interrupts, this bit is not implemented (RO and reads returns 0).
2:0	RO	0	<i>Reserved</i>

4.5 SAD—System Address Decoder Registers

4.5.1 SAD_PAM0123

Register for legacy device 0, function 0, 90h–93h address space.

Device: 0 Function: 1 Offset: 40h Access as a DWord			
Bit	Attr	Default	Description
31:29	RO	0	<i>Reserved</i>
29:28	RW	0	PAM3_HIENABLE. 0D4000–0D7FFFh Attribute (HIENABLE) This field controls the steering of read and write cycles that address the BIOS area from 0D4000h to 0D7FFFh. 00 = DRAM Disabled — All accesses are directed to DMI. 01 = Read Only — All reads are sent to DRAM. All writes are forwarded to DMI. 10 = Write Only — All writes are sent to DRAM. Reads are serviced by DMI. 11 = Normal DRAM Operation — All reads and writes are serviced by DRAM.

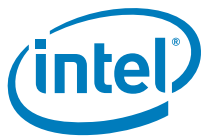

Device: 0 Function: 1 Offset: 40h Access as a DWord			
Bit	Attr	Default	Description
27:26	RO	0	<i>Reserved</i>
25:24	RW	0	PAM3_LOENABLE. 0D0000h–0D3FFFh Attribute (LOENABLE) This field controls the steering of read and write cycles that address the BIOS area from 0D0000h to 0D3FFFh 00 = DRAM Disabled — All accesses are directed to DMI. 01 = Read Only — All reads are sent to DRAM. All writes are forwarded to DMI. 10 = Write Only — All writes are send to DRAM. Reads are serviced by DMI. 11 = Normal DRAM Operation — All reads and writes are serviced by DRAM.
23:22	RO	0	<i>Reserved</i>
21:20	RW	0	PAM2_HIENABLE. 0CC000h–0CFFFFh Attribute (HIENABLE) This field controls the steering of read and write cycles that address the BIOS area from 0CC000h to 0CFFFFh. 00 = DRAM Disabled — All accesses are directed to DMI. 01 = Read Only — All reads are sent to DRAM. All writes are forwarded to DMI. 10 = Write Only — All writes are send to DRAM. Reads are serviced by DMI. 11 = Normal DRAM Operation — All reads and writes are serviced by DRAM.
19:18	RO	0	<i>Reserved</i>
17:16	RW	0	PAM2_LOENABLE. 0C8000h–0CBFFFh Attribute (LOENABLE) This field controls the steering of read and write cycles that address the BIOS area from 0C8000h to 0CBFFFh. 00 = DRAM Disabled — All accesses are directed to DMI. 01 = Read Only — All reads are sent to DRAM. All writes are forwarded to DMI. 10 = Write Only — All writes are send to DRAM. Reads are serviced by DMI. 11 = Normal DRAM Operation — All reads and writes are serviced by DRAM.
35:14	RO	0	<i>Reserved</i>
13:12	RW	0	PAM1_HIENABLE. 0C4000h–0C7FFFh Attribute (HIENABLE) This field controls the steering of read and write cycles that address the BIOS area from 0C4000h to 0C7FFFh. 00 = DRAM Disabled — All accesses are directed to DMI. 01 = Read Only — All reads are sent to DRAM. All writes are forwarded to DMI. 10 = Write Only — All writes are send to DRAM. Reads are serviced by DMI. 11 = Normal DRAM Operation — All reads and writes are serviced by DRAM.
11:10	RO	0	<i>Reserved</i>
9:8	RW	0	PAM1_LOENABLE. 0C0000h–0C3FFFh Attribute (LOENABLE) This field controls the steering of read and write cycles that address the BIOS area from 0C0000h to 0C3FFFh. 00 = DRAM Disabled — All accesses are directed to DMI. 01 = Read Only — All reads are sent to DRAM. All writes are forwarded to DMI. 10 = Write Only — All writes are send to DRAM. Reads are serviced by DMI. 11 = Normal DRAM Operation — All reads and writes are serviced by DRAM.
7:6	RO	0	<i>Reserved</i>
5:4	RW	0	PAM0_HIENABLE. 0F0000h–0FFFFFh Attribute (HIENABLE) This field controls the steering of read and write cycles that address the BIOS area from 0F0000h to 0FFFFFh. 00 = DRAM Disabled — All accesses are directed to DMI. 01 = Read Only — All reads are sent to DRAM. All writes are forwarded to DMI. 10 = Write Only — All writes are send to DRAM. Reads are serviced by DMI. 11 = Normal DRAM Operation — All reads and writes are serviced by DRAM.
3:0	RO	0	<i>Reserved</i>



4.5.2 SAD_PAM456

Register for legacy device 0, function 0, 94h-97h address space.

Device: 0 Function: 1 Offset: 44h Access as a DWord			
Bit	Attr	Default	Description
31:22	RO	0	<i>Reserved</i>
21:20	RW	0	PAM6_HIENABLE. 0EC000h–0EFFFFh Attribute (HIENABLE) This field controls the steering of read and write cycles that address the BIOS area from 0EC000h to 0EFFFFh. 00 = DRAM Disabled — All accesses are directed to DMI. 01 = Read Only — All reads are sent to DRAM. All writes are forwarded to DMI. 10 = Write Only — All writes are send to DRAM. Reads are serviced by DMI. 11 = Normal DRAM Operation — All reads and writes are serviced by DRAM.
17:16	RW	0	PAM6_LOENABLE. 0E8000h–0EBFFFh Attribute (LOENABLE) This field controls the steering of read and write cycles that address the BIOS area from 0E8000h to 0EBFFFh. 00 = DRAM Disabled — All accesses are directed to DMI. 01 = Read Only — All reads are sent to DRAM. All writes are forwarded to DMI. 10 = Write Only — All writes are send to DRAM. Reads are serviced by DMI. 11 = Normal DRAM Operation — All reads and writes are serviced by DRAM.
15:14	RO	0	<i>Reserved</i>
13:12	RW	0	PAM5_HIENABLE. 0E4000h–0E7FFFh Attribute (HIENABLE) This field controls the steering of read and write cycles that address the BIOS area from 0E4000h to 0E7FFFh. 00 = DRAM Disabled — All accesses are directed to DMI. 01 = Read Only — All reads are sent to DRAM. All writes are forwarded to DMI. 10 = Write Only — All writes are send to DRAM. Reads are serviced by DMI. 11 = Normal DRAM Operation — All reads and writes are serviced by DRAM.
11:10	RO	0	<i>Reserved</i>
9:8	RW	0	PAM5_LOENABLE. 0E0000h–0E3FFFh Attribute (LOENABLE) This field controls the steering of read and write cycles that address the BIOS area from 0E0000h to 0E3FFFh. 00 = DRAM Disabled — All accesses are directed to DMI. 01 = Read Only — All reads are sent to DRAM. All writes are forwarded to DMI. 10 = Write Only — All writes are send to DRAM. Reads are serviced by DMI. 11 = Normal DRAM Operation — All reads and writes are serviced by DRAM.
7:6	RO	0	<i>Reserved</i>
5:4	RW	0	PAM4_HIENABLE. 0DC000h–0DFFFFh Attribute (HIENABLE) This field controls the steering of read and write cycles that address the BIOS area from 0DC000h to 0DFFFFh. 00 = DRAM Disabled — All accesses are directed to DMI. 01 = Read Only — All reads are sent to DRAM. All writes are forwarded to DMI. 10 = Write Only — All writes are send to DRAM. Reads are serviced by DMI. 11 = Normal DRAM Operation — All reads and writes are serviced by DRAM.
3:2	RO	0	<i>Reserved</i>
1:0	RW	0	PAM4_LOENABLE. 0D8000h–0DBFFFh Attribute (LOENABLE) This field controls the steering of read and write cycles that address the BIOS area from 0D8000h to 0DBFFFh. 00 = DRAM Disabled — All accesses are directed to DMI. 01 = Read Only — All reads are sent to DRAM. All writes are forwarded to DMI. 10 = Write Only — All writes are send to DRAM. Reads are serviced by DMI. 11 = Normal DRAM Operation — All reads and writes are serviced by DRAM.

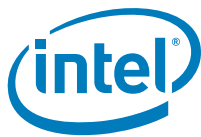

4.5.3 SAD_HEN

Register for legacy Hole Enable.

Device: 0 Function: 1 Offset: 48h Access as a DWord			
Bit	Attr	Default	Description
31:8	RO	0	Reserved
7	RW	0	HEN This field enables a memory hole in DRAM space. The DRAM that lies "behind" this space is not remapped. 0 = No Memory hole. 1 = Memory hole from 15 MB to 16 MB.
6:0	RO	0	Reserved

4.5.4 SAD_SMRAM

Register for legacy 9Dh address space.

Device: 0 Function: 1 Offset: 4Ch Access as a DWord			
Bit	Attr	Default	Description
31:15	RO	0	Reserved
14	RW	0	SMM Space Open (D_OPEN) When D_OPEN=1 and D_LCK=0, the SMM space DRAM is made visible even when SMM decode is not active. This is intended to help BIOS initialize SMM space. Software should ensure that D_OPEN=1 and D_CLS=1 are not set at the same time.
13	RW	0	SMM Space Closed (D_CLS) When D_CLS = 1, SMM space DRAM is not accessible to data references, even if SMM decode is active. Code references may still access SMM space DRAM. This will allow SMM software to reference through SMM space to update the display even when SMM is mapped over the VGA range. Software should ensure that D_OPEN=1 and D_CLS=1 are not set at the same time.
12	RW1S	0	SMM Space Locked (D_LCK) When D_LCK is set to 1, D_OPEN is reset to 0 and D_LCK, D_OPEN, C_BASE_SEG, G_SMRAME, PCI ExpressXBAR, (DRAM_RULEs and INTERLEAVE_LISTs), become read only. D_LCK can be set to 1 using a normal configuration space write but can only be cleared by a Reset. The combination of D_LCK and D_OPEN provide convenience with security. The BIOS can use the D_OPEN function to initialize SMM space and then use D_LCK to "lock down" SMM space in the future so that no application software (or BIOS itself) can violate the integrity of SMM space, even if the program has knowledge of the D_OPEN function. Note that TAD does not implement this lock.
11	RW	0	Global SMRAM Enable (G_SMRAME) If set to a 1, Compatible SMRAM functions are enabled, providing 128 KB of DRAM, accessible at the A0000h address while in SMM (ADSB with SMM decode). To enable Extended SMRAM function this bit has to be set to 1. Once D_LCK is set, this bit becomes read only.
10:8	RO	-	Compatible SMM Space Base Segment (C_BASE_SEG) This field indicates the location of SMM space. SMM DRAM is not remapped. It is simply made visible if the conditions are right to access SMM space, otherwise the access is forwarded to HI. Only SMM space between A0000 and BFFFF is supported so this field is hardwired to 010.
7:0	RO	0	Reserved

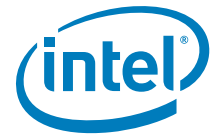

4.5.5 SAD_PCIEXBAR

Global register for PCI ExpressXBAR address space.

Device: 0 Function: 1 Offset: 50h Access as a QWord			
Bit	Attr	Default	Description
63:40	RV	0	<i>Reserved</i>
39:20	RW	0	ADDRESS Base address of PCI ExpressXBAR. Must be naturally aligned to size; low order bits are ignored.
19:4	RO	0	<i>Reserved</i>
3:1	RW	0	SIZE Size of the PCI ExpressXBAR address space. (MAX bus number). 000 = 256 MB 001 = Reserved 010 = Reserved 011 = Reserved 100 = Reserved 101 = Reserved 110 = 64 MB 111 = 128 MB
0	RW	0	ENABLE Enable for PCI ExpressXBAR address space. Editing size should not be done without also enabling range.

4.5.6 SAD_TPCIEXBAR

Global register for trusted PCIEXBAR address space. Bus number comes from PCIEXBAR.

Device: 0 Function: 1 Offset: 58h Access as a QWord			
Bit	Type	Default	Description
63:40	RV	0	<i>Reserved</i>
39:20	RW	0	ADDRESS Base address of PCIEXBAR. Must be naturally aligned to size; low order bits are ignored.
19:1	RO	0	<i>Reserved</i>
0	RW	0	ENABLE Enable for PCIEXBAR address space.



4.5.7 SAD_MCSEG_BASE

Global register for McSEG address space. These are designed to look just like the cores SMRR type registers.

Device: 0 Function: 1 Offset: 60h Access as a QWord			
Bit	Type	Default	Description
63:40	RV	0	Reserved
39:19	RW	0	BASE_ADDRESS Base address of McSEG. Must be 4K aligned (space must be power of 2 aligned).
18:0	RO	0	Reserved

4.5.8 SAD_MCSEG_MASK

Global register for McSEG address space. These are designed to look just like the cores SMRR type registers.

Device: 0 Function: 1 Offset: 68h Access as a QWord			
Bit	Type	Default	Description
63:40	RV	0	Reserved
39:19	RW	0	MASK Mask of McSEG. Space must be power of 2 aligned.
18:12	RO	0	Reserved
11	RW	0	ENABLE Is McSeg Enabled.
10	RW	0	LOCK Is McSeg/Mask register locked.
9:0	RO	0	Reserved

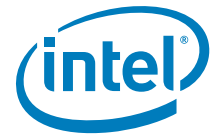

4.5.9 SAD_MESEG_BASE

Register for Intel Management Engine (Intel ME) range base address.

Device: 0 Function: 1 Offset: 70h Access as a QWord			
Bit	Attr	Default	Description
63:40	RV	0	<i>Reserved</i>
39:19	RW	0	BASE ADDRESS Base address of Intel ME SEG. Must be 4-K aligned (space must be power of 2 aligned).
18:0	RO	0	<i>Reserved</i>

4.5.10 SAD_MESEG_MASK

Register for Intel ME mask.

Device: 0 Function: 1 Offset: 78h Access as a QWord			
Bit	Attr	Default	Description
63:40	RV	0	<i>Reserved</i>
39:19	RW	0	MASK Mask of Intel ME SEG. Space must be power of 2 aligned. Field indicates which bits must match the BASE in order to be inside the Intel ME range.
11	RW	0	ENABLE Enable for Intel ME SEG. When enabled, all core access to Intel ME SEG space is aborted.
10	RWL	0	LOCK Lock for Intel ME SEG base and mask.
9:0	RO	0	<i>Reserved</i>

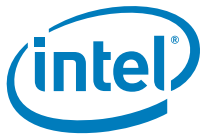

4.5.11 SAD_DRAM_RULE_0; SAD_DRAM_RULE_1
 SAD_DRAM_RULE_2; SAD_DRAM_RULE_3
 SAD_DRAM_RULE_4; SAD_DRAM_RULE_5
 SAD_DRAM_RULE_6; SAD_DRAM_RULE_7

SAD DRAM rules. Address Map for package determination.

Device: 0 Function: 1 Offset: 80h, 84h, 88h, 8Ch, 90h, 94h, 98h, 9Ch Access as a DWord			
Bit	Attr	Default	Description
31:20	RV	0	<i>Reserved</i>
19:6	RW	-	LIMIT. DRAM rule top limit address This bit must be strictly greater than previous rule, even if this rule is disabled, unless this rule and all following rules are disabled. Lower limit is the previous rule (or 0 if it is first rule). This field is compared against MA[39:26] in the memory address map.
5:3	RO	0	<i>Reserved</i>
2:1	RW	-	MODE. DRAM rule interleave mode If a DRAM_RULE hits, a 3-bit number is used to index into the corresponding interleave_list to determine which package the DRAM belongs to. This mode selects how that number is computed. 00 = Address bits {8,7,6}. 01 = Address bits {8,7,6} XORed with {18,17,16}. 10 = Address bit {6}, MOD3(Address[39..6]). (Note 6 is the high order bit) 11 = Reserved.
0	RW	0	ENABLE. Enable for DRAM rule If Enabled Range between this rule and previous rule is Directed to HOME channel (unless overridden by other dedicated address range registers). If disabled, all accesses in this range are directed in MMIO to the I1H.

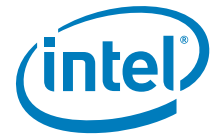

**4.5.12 SAD_INTERLEAVE_LIST_0; SAD_INTERLEAVE_LIST_1
SAD_INTERLEAVE_LIST_2; SAD_INTERLEAVE_LIST_3
SAD_INTERLEAVE_LIST_4; SAD_INTERLEAVE_LIST_5
SAD_INTERLEAVE_LIST_6; SAD_INTERLEAVE_LIST_7**

This register contains SAD DRAM package assignments. When the corresponding DRAM_RULE hits, a 3-bit number (determined by mode) is used to index into the interleave_list to determine which package is the HOME for this address.

- 00 = IIH
- 01 = Socket 0
- 10 = Reserved
- 11 = Reserved

Device: 0 Function: 1 Offset: C0h, C4h, C8h, CCh, D0h, D4h, D8h, DCh Access as a DWord			
Bit	Attr	Default	Description
31:30	RO	0	Reserved
29:28	RW	0	PACKAGE7. Package for group 7 of interleaves.
27:26	RO	0	Reserved
25:24	RW	0	PACKAGE6. Package for group 6 of interleaves.
23:22	RO	0	Reserved
21:20	RW	0	PACKAGE5. Package for group 5 of interleaves.
19:18	RO	0	Reserved
17:16	RW	0	PACKAGE4. Package for group 4 of interleaves.
15:14	RO	0	Reserved
13:12	RW	0	PACKAGE3. Package for group 3 of interleaves.
11:10	RO	0	Reserved
9:8	RW	0	PACKAGE2. Package for group 2 of interleaves.
7:6	RO	0	Reserved
5:4	RW	0	PACKAGE1. Package for group 1 of interleaves.
3:2	RO	0	Reserved
1:0	RW	0	PACKAGE0. Package for group 0 of interleaves.

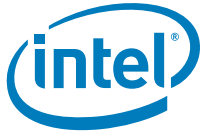

4.6 Intel® QuickPath Interconnect Link Registers

4.6.1 QPI_QPILCL_LO

Intel QuickPath Interconnect Link Control.

Device: 2 Function: 0 Offset: 48h Access as a DWord			
Bit	Type	Default	Description
31:22	RO	0	<i>Reserved</i>
21	RW	0	L1_MASTER Indicates that this end of the link is the L1 master. This link transmitter bit is an L1 power state master and can initiate an L1 power state transition. If this bit is not set, then the link transmitter is an L1 power state slave and should respond to L1 transitions with an ACK or NACK. If the link power state of L1 is enabled, then there is one master and one slave per link. The master may only issue single L1 requests, while the slave can only issue single L1_Ack or L1_NAck responses for the corresponding request. This link transmitter bit is an L1 power state master and can initiate an L1 power state transition. If this bit is not set, then the link transmitter is an L1 power state slave and should respond to L1 transitions with an ACK or NACK. If the link power state of L1 is enabled, there is one master and one slave per link. The master may only issue single L1 requests, while the slave can only issue single L1_Ack or L1_NAck responses for the corresponding request.
20	RW	0	L1_ENABLE Enables L1 mode at the transmitter. This bit should be ANDed with the receive L1 capability bit received during parameter exchange to determine if a transmitter is allowed to enter into L1. This is NOT a bit that determines the capability of a device. at the transmitter. This bit should be ANDed with the receive L1 capability bit received during parameter exchange to determine if a transmitter is allowed to enter into L1. This is NOT a bit that determines the capability of a device.
19	RO	0	<i>Reserved</i>
18	RW	0	LOS_ENABLE Enables L0s mode at the transmitter. This bit should be ANDed with the receive L0s capability bit received during parameter exchange to determine if a transmitter is allowed to enter into L0s. This is NOT a bit that determines the capability of a device. at the transmitter. This bit should be ANDed with the receive L0s capability bit received during parameter exchange to determine if a transmitter is allowed to enter into L0s. This is NOT a bit that determines the capability of a device.
17	RWST	0	STALL_RDY_FOR_NORMAL Link Layer Initialization stall (on next initialization) — Sticky. 0 = Disable 1 = Enable, stall initialization until this bit is cleared.
16	RWST	0	STALL_RDY_FOR_INIT Link Layer Initialization stall (on next initialization) — Sticky. 0 = Disable 1 = Enable, stall initialization until this bit is cleared.
15:8	RO	0	<i>Reserved</i>
7:6	RWST	0	LLR_TIMEOUT Link Level Retry (LLR) timeout value in flit cycles — Sticky, Late action. 00 = 4095 01 = 1023 10 = 255 11 = 63.

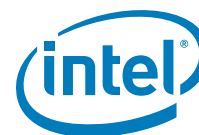

Device: 2 Function: 0 Offset: 48h Access as a DWord			
Bit	Type	Default	Description
5:4	RWST	0	LLR_TO_LINK_RESET Consecutive LLRs to Link Reset — Sticky, Late action. 00 = up to 16 01 = up to 8 10 = up to 4 11 = 0, disable LLR (if CRC error, immediate error condition).
3:2	RWST	0	LINK_RESET_FROM_LL Consecutive Link Reset from LLR till error condition (only applies if LLR enabled) — Sticky, Late action. 00 = up to 2 01 = up to 1 10 = up to 0 11 = Reserved.
1	RW	0	LINK_HARD_RESET . Link Hard Reset Re-initialize resetting values in sticky registers. Write 1 to reset this link. This is a destructive reset. When reset asserts, register clears to 0h.
0	RW	0	LINK_SOFT_RESET . Link Soft Reset Re-initialize without resetting sticky registers. Write 1 to reset this link. This is a destructive reset. When reset asserts, register clears to 0h.



4.7 Integrated Memory Controller Control Registers

4.7.1 MC_CONTROL

Primary control register.

Device: 3 Function: 0 Offset: 48h Access as a DWord			
Bit	Attr	Default	Description
31:8	RO	0	<i>Reserved</i>
9	RW	0	CHANNEL1_ACTIVE When set, this bit indicates MC channel 1 is active. This bit is controlled (set/reset) by software only. This bit is required to be set for any active channel when INIT_DONE is set by software.
8	RW	0	CHANNEL0_ACTIVE When set, this bit indicate MC channel 0 is active. This bit is controlled (set/reset) by software only. This bit is required to be set for any active channel when INIT_DONE is set by software.
7	WO	0	INIT_DONE MC initialize complete signal. Setting this bit will exit the training mode of the Integrated Memory Controller and begin normal operation including all enabled maintenance operations. Any CHANNNEL_ACTIVE bits not set when writing a 1 to INIT_DONE will cause the corresponding channel to be disabled.
6	RW	0	DIVBY3EN. Divide By 3 Enable When set, MAD would use the longer pipeline for transactions that are 3- or 6-way interleaved and shorter pipeline for all other transactions. The SAG registers must be appropriately programmed as well.
5	RO	0	<i>Reserved</i>
4	RW	0	CHANNELRESET1 Reset only the state within the channel. Equivalent to pulling warm reset for that channel.
3	RW	0	CHANNELRESET0 Reset only the state within the channel. Equivalent to pulling warm reset for that channel.
2	RW	0	AUTOPRECHARGE. Autoprecharge Enable This bit should be set with the closed page bit. If it is not set with closed page, address decode will be done without setting the autoprecharge bit.
1			<i>Reserved</i>
0	RW	0	CLOSED_PAGE When set, the MC supports a Closed Page policy. The default is Open Page but BIOS should always configure this bit.



4.7.2 MC_SMI_DIMM_ERROR_STATUS

SMI DIMM error threshold overflow status register. This bit is set when the per-DIMM error counter exceeds the specified threshold. The bit is reset by BIOS.

Device: 3 Function: 0 Offset: 50h Access as a DWord			
Bit	Type	Default	Description
31:14	RO	0	<i>Reserved</i>
13:12	RWOC	0	REDUNDANCY_LOSS_FAILING_DIMM The ID for the failing DIMM when redundancy is lost.
11:8			<i>Reserved</i>
7:0	RWOC	0	DIMM_ERROR_OVERFLOW_STATUS This 8-bit field is the per DIMM error overflow status bits. The organization is as follows: If there are one or two DIMMS on the channel: Bit 0 = DIMM 0, Ranks 0 and 1, Channel 0 Bit 1 = DIMM 0, Ranks 2 and 3, Channel 0 Bit 2 = DIMM 1, Ranks 0 and 1, Channel 0 Bit 3 = DIMM 1, Ranks 2 and 3, Channel 0 Bit 4 = DIMM 0, Ranks 0 and 1, Channel 1 Bit 5 = DIMM 0, Ranks 2 and 3, Channel 1 Bit 6 = DIMM 1, Ranks 0 and 1, Channel 1 Bit 7 = DIMM 1, Ranks 2 and 3, Channel 1

4.7.3 MC_SMI_CNTRL

System Management Interrupt control register.

Device: 3 Function: 0 Offset: 54h Access as a DWord			
Bit	Type	Default	Description
31:17	RO	0	<i>Reserved</i>
16	RW	0	INTERRUPT_SELECT_NMI . NMI Enable This bit is set to enable NMI signaling. Clear to disable NMI signaling. If both NMI and SMI enable bits are set, then only SMI is sent.
15	RW	0	INTERRUPT_SELECT_SMI . SMI Enable. This bit is set to enable SMI signaling. Clear to disable SMI signaling. If both NMI and SMI enable bits are set, then only SMI is sent.
14:0	RW	0	<i>Reserved</i>



4.7.4 MC_STATUS

MC Primary Status register.

Device: 3 Function: 0 Offset: 4Ch Access as a DWord			
Bit	Attr	Default	Description
31:17	RO	0	Reserved
4	RO	1	Reserved
3	RO	0	Reserved
2	RO	0	Reserved
1	RO	0	CHANNEL1_DISABLED. Channel 1 is disabled. This can be factory configured or if Init done is written without the channel_active being set. Clocks in the channel will be disabled when this bit is set.
0	RO	0	CHANNELO_DISABLED. Channel 0 is disabled. This can be factory configured or if Init done is written without the channel_active being set. Clocks in the channel will be disabled when this bit is set.

4.7.5 MC_RESET_CONTROL

DIMM Reset enabling controls.

Device: 3 Function: 0 Offset: 5Ch Access as a DWord			
Bit	Attr	Default	Description
31:1	RO	0	Reserved
0	WO	0	BIOS_RESET_ENABLE When set, MC takes over control of driving RESET to the DIMMs. This bit is set on S3 exit and cold boot to take over RESET driving responsibility from the physical layer.

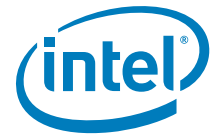

4.7.6 MC_CHANNEL_MAPPER

Channel mapping register. The sequence of operations to update this register is:

- Read MC_Channel Mapper register
- Compare data read to be written. If different then write.
- Poll MC_Channel Mapper register until the data read matches data written.

Device: 3 Function: 0 Offset: 60h Access as a DWord			
Bit	Attr	Default	Description
31:12	RO	0	Reserved
11:9	RW	0	RDLCH1 Mapping of Logical channel 1 to physical channel for Reads.
8:6	RW	0	WRLCH1 Mapping of Logical channel 1 to physical channel for Writes.
5:3	RW	0	RDLCH0 Mapping of Logical channel 0 to physical channel for Read.
2:0	RW	0	WRLCH0 Mapping of Logical channel 0 to physical channel for Writes.

4.7.7 MC_MAX_DOD

This register defines the MAX number of DIMMS, RANKS, BANKS, ROWS, COLS among all DIMMS populating the two channels. The Memory Init logic uses this register to cycle through all the memory addresses writing all 0s to initialize all locations.

Device: 3 Function: 0 Offset: 64h Access as a DWord			
Bit	Attr	Default	Description
31:11	RO	0	Reserved
10:9	RW	0	MAXNUMCOL. Maximum Number of Columns 00 = 2 ¹⁰ columns 01 = 2 ¹¹ columns 10 = 2 ¹² columns 11 = Reserved
8:6	RW	0	MAXNUMROW. Maximum Number of Rows 000 = 2 ¹² Rows 001 = 2 ¹³ Rows 010 = 2 ¹⁴ Rows 011 = 2 ¹⁵ Rows 100 = 2 ¹⁶ Rows Others = Reserved.
5:4	RW	0	MAXNUMBANK. Maximum Number of Banks 00 = Four-banked 01 = Eight-banked 10 = Sixteen-banked

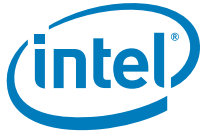

Device: 3 Function: 0 Offset: 64h Access as a DWord			
Bit	Attr	Default	Description
3:2	RW	0	MAXNUMRANK. Maximum Number of Ranks 00 = Single Ranked 01 = Double Ranked 10 = <i>Reserved</i>
1:0	RW	0	MAXNUMDIMMS. Maximum Number of DIMMs 00 = 1 DIMM 01 = 2 DIMMs 10 = <i>Reserved</i> 11 = <i>Reserved</i>

4.7.8 MC_CFG_LOCK

BIOS must write the MC_CFG_LOCK bit after configuration is complete to allow the Integrated Memory Controller to start accepting requests.

Device: 3 Function: 0 Offset: 68h Access as a DWord			
Bit	Attr	Default	Description
31:2	RO	0	<i>Reserved</i>
1	WO	0	MC_CFG_UNLOCK This bit unlocks the Integrated Memory Controller configuration registers without processor reset. This bit does NOT unlock any other lock type without a processor reset.
0	WO	0	MC_CFG_LOCK This bit locks the Integrated Memory Controller configuration registers. Writes are no longer allowed to the configuration registers.

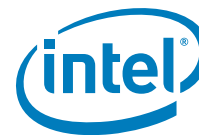

4.7.9 MC_RD_CRDT_INIT

These registers contain the initial read credits available for issuing memory reads. TAD read credit counters are loaded with the corresponding values at reset and anytime this register is written. BIOS must initialize this register with appropriate values depending on the level of Isoch support in the platform. It is illegal to write this register while TAD is active (has memory requests outstanding), as the write will break TAD's outstanding credit count values.

Register programming rules:

- Total read credits (CRDT_RD + CRDT_RD_HIGH + CRDT_RD_CRIT) must not exceed 31.
- CRDT_RD_HIGH value must correspond to the number of high RTIDs reserved at the IIH.
- CRDT_RD_CRIT value must correspond to the number of critical RTIDs reserved at the IIH.
- CRDT_RD_HIGH + CRDT_RD must be less than or equal to 13.
- CRDT_RD_HIGH + CRDT_RD_CRIT must be less than or equal to 8.
- CRDT_RD_CRIT must be less than or equal to 6. Set CRDT_RD to (16 - CRDT_RD_CRIT - CRDT_RD_HIGH).
- Max for CRDT_RD is 15.
- If (Isoch not enabled) then CRDT_RD_HIGH and CRDT_RD_CRIT are set to 0.

Device: 3 Function: 0 Offset: 70h Access as a DWord			
Bit	Attr	Default	Description
31:21	RO	0	<i>Reserved</i>
20:16	RW	3	CRDT_RD_CRIT Critical Read Credits.
15:13	RO	0	<i>Reserved</i>
12:8	RW	1	CRDT_RD_HIGH High Read Credits.
7:5	RO	0	<i>Reserved</i>
4:0	RW	13	CRDT_RD Normal Read Credits.

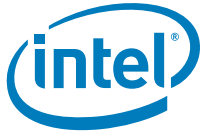

4.7.10 MC_CRDT_WR_THLD

Memory Controller Write Credit Thresholds. A Write threshold is defined as the number of credits reserved for this priority (or higher) request. It is required that High threshold be greater than or equal to Crit threshold, and that both be lower than the total Write Credit init value. BIOS must initialize this register with appropriate values depending on the level of Isoch support in the platform. The new values take effect immediately upon being written.

Register programming rules:

- CRIT threshold value must correspond to the number of critical RTIDs reserved at the IIH.
- HIGH threshold value must correspond to the sum of critical and high RTIDs reserved at the IIH (which must not exceed 30).
- Set MC_Channel_*_WAQ_PARAMS.ISOCENTRYTHRESHHOLD equal to (31-CRIT.)

Device: 3 Function: 0 Offset: 74h Access as a DWord			
Bit	Attr	Default	Description
31:13	RO	0	Reserved
12:8	RW	4	HIGH High Credit Threshold.
7:5	RO	0	Reserved
4:0	RW	3	CRIT Critical Credit Threshold.

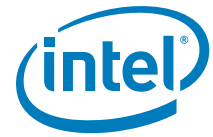

4.8 TAD—Target Address Decoder Registers

4.8.1 TAD_DRAM_RULE_0; TAD_DRAM_RULE_1 TAD_DRAM_RULE_2; TAD_DRAM_RULE_3 TAD_DRAM_RULE_4; TAD_DRAM_RULE_5 TAD_DRAM_RULE_6; TAD_DRAM_RULE_7

TAD DRAM rules. Address map for channel determination within a package. All addresses sent to this HOME agent must hit a valid enabled DRAM_RULE. No error will be generated if they do not and memory aliasing will happen.

Device: 3 Function: 1 Offset: 80h, 84h, 88h, 8Ch, 90h, 94h, 98h, 9Ch Access as a DWord			
Bit	Attr	Default	Description
31:20	RO	0	<i>Reserved</i>
19:6	RW	-	LIMIT. DRAM rule top limit address This field must be strictly greater than previous rule, even if this rule is disabled, unless this rule and all following rules are disabled. Lower limit is the previous rule (or 0 if it is the first rule).
5:3	RO	0	<i>Reserved</i>
2:1	RW	-	MODE. DRAM rule interleave mode If a DRAM_RULE hits, a 3-bit number is used to index into the corresponding interleave_list to determine which channel the DRAM belongs to. This mode selects how that number is computed. 00 = Address bits {8,7,6}. 01 = Address bits {8,7,6} XORed with {18,17,16}. 10 = Address bit {6}, MOD3(Address[39..6]). (Note 6 is the high order bit) 11 = reserved.
0	RW	0	ENABLE. Enable for DRAM rule

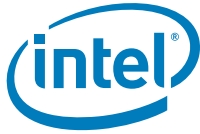

4.8.2 TAD_INTERLEAVE_LIST_0; TAD_INTERLEAVE_LIST_1 TAD_INTERLEAVE_LIST_2; TAD_INTERLEAVE_LIST_3 TAD_INTERLEAVE_LIST_4; TAD_INTERLEAVE_LIST_5 TAD_INTERLEAVE_LIST_6; TAD_INTERLEAVE_LIST_7

TAD DRAM package assignments. When the corresponding DRAM_RULE hits, a 3-bit number (determined by mode) is used to index into the Interleave_List Branches to determine which channel the DRAM request belongs to.

Device: 3 Function: 1 Offset: C0h, C4h, C8h, CCh, D0h, D4h, D8h, DCh Access as a DWord			
Bit	Attr	Default	Description
31:30	RO	0	<i>Reserved</i>
29:28	RW	-	Branch7. Branch (or index) 111 of the Interleave List. Bits determined from the matching TAD_DRAM_RULE mode.
27:26	RO	-	<i>Reserved</i>
25:24	RW	-	Branch6. Branch (or index) 110 of the Interleave List. Bits determined from the matching TAD_DRAM_RULE mode.
23:22	RO	-	<i>Reserved</i>
21:20	RW	-	Branch5. Branch (or index) 101 of the Interleave List. Bits determined from the matching TAD_DRAM_RULE mode.
19:18	RO	-	<i>Reserved</i>
17:16	RW	-	Branch4. Branch (or index) 100 of the Interleave List. Bits determined from the matching TAD_DRAM_RULE mode.
15:14	RO	-	<i>Reserved</i>
13:12	RW	-	Branch3. Branch (or index) 011 of the Interleave List. Bits determined from the matching TAD_DRAM_RULE mode.
11:10	RO	-	<i>Reserved</i>
9:8	RW	-	Branch2. Branch (or index) 010 of the Interleave List. Bits determined from the matching TAD_DRAM_RULE mode.
7:6	RO	-	<i>Reserved</i>
5:4	RW	-	Branch1. Branch (or index) 001 of the Interleave List. Bits determined from the matching TAD_DRAM_RULE mode.
3:2	RO	-	<i>Reserved</i>
1:0	RW	-	Branch0. Branch (or index) 000 of the Interleave List. Bits determined from the matching TAD_DRAM_RULE mode.

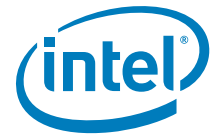

4.9 Integrated Memory Controller Test Registers

4.9.1 Integrated Memory Controller Padsca

Table 4-18. Padsca Accessible Parameters

Parameters Accessible	Per channel	Per Rank	Per Strobe (4 pin) Group
Receive Enable Training	Yes	Yes	Yes
RD DQ-DQS Training	Yes	Yes	Yes
WR DQ-DQS Training	Yes	Yes	Yes
Write Leveling Training	Yes	Yes	Yes
CS-ODT Timing & Control	Yes	No	No
Timing Delays for CMD Pins	Yes	No	No
Rank Clock Disable	Yes	Yes	No
Clock Delay	Yes	Yes	No
Transmitter Equalization Control	Yes	No	No
CKE Delay	Yes	Yes	No
Clock Slew Rate Control	No	No	No
Data Buffer Pull-up Impedance	No	No	No
IO Training Max Jitter Control	No	No	No
IO Training Number of Samples	No	No	No
Scramble Control	No	No	No
OTD compensation Control	No	No	No
DQ Driver Compensation Control	No	No	No

There are four scan chains (1 for each channel and 1 global).

Table 4-19. Scan Chains

Scan Chain	Chain Length (Subject to Change)
Channel 0	5261 bits
Channel 1	5261 bits
Global chain	539 bits

Each chain is broken into smaller “sections”. Each section is composed of N bits where $N \leq 32$. Each section is used to read/write a particular parameter. Each section contains $N - 2$ data bits (that is, the parameter to be read/written). Each section has two additional bits: a Mask bit, and a Halt bit.

The mask and halt bits are defined as shown in Table 4-20.

Table 4-20. Halt and Mask Bit Usage

Mask	Halt	Function
0	X	Serial data is not loaded into the shadow register
1	0	Serial data is loaded into shadow register but will be overwritten
1	1	Serial data is loaded into shadow register and held until halt is cleared. This is the most commonly used setting.

There are 3 registers defined for Padscan usage.

Table 4-21. Padscan Registers

Register Name	Description
MC_TEST_EP_SCCTL	Scan chain control register
MC_TEST_EP_SCD	Scan chain data register
MC_TEST_LTRCON	Scan chain select register

Figure 4-1. Padscan Accessibility Mechanism

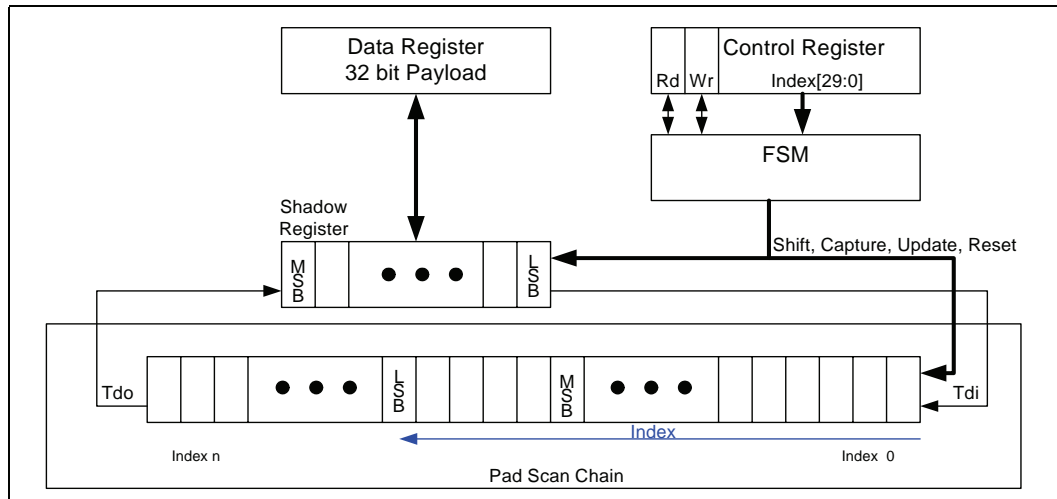

A read operation is performed by writing the index (Chain length — Offset + 38 — length of section + 1) of the section to be read and read bit into the control register. The appropriate scan chain is selected in the scan chain select register. The read is complete when the read bit in the control register is cleared by the Integrated Memory Controller. The control register must be read after the read (write) command is issued to guarantee the read (write) command completes.

When the read data is complete the contents of the data register will be valid. Note that reads will provide a total of 32 bits which may include adjacent sections of the scan chain. For example if section 18 which has 11 bits is read out, the data register will return section 18 in the lower portion of the 32-bit data register along with data from adjacent sections 9 and 1 in the scan chain. The index in this case would be 5271 (5261 — 18 + 38 — 11 + 1). Refer to Figure 4-1.

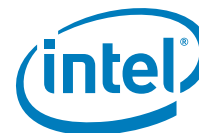

A write operation is performed by writing the payload in the data register including mask and halt bits. The appropriate scan chain is selected in the scan chain select register. The index (offset +length of section –1) is written into the control register along with the write bit. The write is complete when the write bit is cleared. The write is complete when the write bit in the control register is cleared by the Integrated Memory Controller. For optimization adjacent sections that fit within 32 bits may be written together. For example a write to adjacent sections 40 (length 11 bits), 51 (length 11 bits) and 62 (length 8 bits) can be written in one write operation because they are a total of 30 bits which fits in the data register without overlap into other sections. Section 40 would be shifted left by 30 bits into the data register. Section 51 would be shifted left 20 bits into the data register. Section 62 would be shifted left by 8 bits into the data register. Bit positions 31 and 30 would be left over as zeros in the data register. When the write operation begins Section 62 will be shifted in first followed by sections 51 and 40. The index that is programmed into the control register in this case would be 69 (62 + 8 – 1). Refer to [Figure 4-1](#).

4.9.2 MC_DIMM_CLK_RATIO_STATUS

This register contains status information about DIMM clock ratio.

Device: 3 Function: 4 Offset: 50h Access as a DWord			
Bit	Attr	Default	Description
31:29	RO	0	<i>Reserved</i>
28:24	RO	0	MAX_RATIO. Maximum ratio allowed by the part. Value – Qclk 00000 = RSVD 00010 = 266 MHz 00100 = 533 MHz 00110 = 800 MHz 01000 = 1066 MHz 01010 = 1333 MHz
23:5	RO	0	<i>Reserved</i>
4:0	RO	0	QCLK_RATIO Current ratio of Qclk. Value – Qclk. 00000 = RSVD 00010 = 266 MHz 00100 = 533 MHz 00110 = 800 MHz 01000 = 1066 MHz 01010 = 1333 MHz

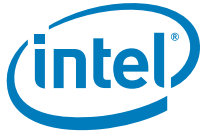

4.9.3 MC_DIMM_CLK_RATIO

Requested DIMM clock ratio (Qclk). This is the data rate going to the DIMM. The clock sent to the DIMM is 1/2 of QCLK rate.

Device: 3 Function: 4 Offset: 54h Access as a DWord			
Bit	Attr	Default	Description
31:5	RO	0	<i>Reserved</i>
4:0	RW	6	QCLK_RATIO Requested ratio of Qclk/Bclk. 00000 = RSVD 00010 = 266 MHz 00100 = 533 MHz 00110 = 800 MHz 01000 = 1066 MHz 01010 = 1333 MHz

4.9.4 MC_TEST_LTRCON

Memory test configuration register.

Device: 3 Function: 4 Offset: 5Ch Access as a DWord			
Bit	Attr	Default	Description
31:27	RO	0	<i>Reserved</i>
26:25	RW	0	Link_Select Selects DDR channel. 00 = Channel 0 01 = Channel 1 10 = Reserved 11 = Global Scan Chain
24:5	RO	0	<i>Reserved</i>
4:0	RW	0	Link_Control

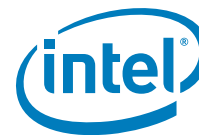

4.9.5 MC_TEST_PH_CTR

Memory test Control Register

Device: 3 Function: 4 Offset: 6Ch Access as a DWord			
Bit	Attr	Default	Description
31:11	RO	0	<i>Reserved</i>
10:8	RW	0	INIT_MODE Initialization Mode
7:0	RO	0	<i>Reserved</i>

4.9.6 MC_TEST_PH_PIS

Memory test physical layer initialization status

Device: 3 Function: 4 Offset: 80h Access as a DWord			
Bit	Attr	Default	Description
31:30	RO	0	<i>Reserved</i>
29	RO	0	GLOBAL_ERROR Indication that an error was detected during a memory test.
28:0	RO	0	<i>Reserved</i>

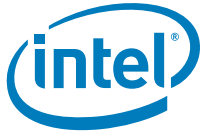

4.9.7 MC_TEST_PAT_GCTR

Pattern Generator Control.

Device: 3 Function: 4 Offset: A8h Access as a DWord			
Bit	Attr	Default	Description
31:29	RO	0	<i>Reserved</i>
28:24	RW	6	EXP_LOOP_CNT Sets the length of the test, defined as $2^{(EXP_LOOP_CNT)}$.
23:22	RO	0	<i>Reserved</i>
21	RW	0	ERROR_COUNT_STALL Masks all detected errors until cleared.
20	RW1S	0	STOP_TEST Force exit from Loopback.Pattern.
19	RW	0	DRIVE_DC_ZERO Drive 0 on lanes with PAT_DCD asserted.
18:14	RO	0	<i>Reserved</i>
13:12	RW	0	PATBUF_WD_SEL Select word within pattern buffer to be written.
11	RO	0	<i>Reserved</i>
10:9	RW	0	PATBUF_SEL Select which pattern buffer will be written when MC_TEST_PAT_BA is written.
8:6	RO	0	<i>Reserved</i>
5	RW	0	IGN_REM_PARAM Slave will ignore remote parameters transmitted in Loopback.Marker.
4	RW	0	ENABLE_LFSR2 Use scrambled output of Pattern Buffer 2.
3	RW	0	ENABLE_LFSR1 Use scrambled output of Pattern Buffer 1.
2	RW	1	ENABLE_AUTOINV Inversion pattern register will rotate automatically once per loop.
1	RW	0	STOP_ON_ERROR Exit Loopback.Pattern upon first detected error.
0	RW1S	0	START_TEST Initiate transition to Loopback.Pattern.

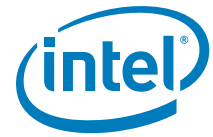

4.9.8 MC_TEST_PAT_BA

Memory Test Pattern Generator Buffer.

Device: 3 Function: 4 Offset: B0h Access as a DWord			
Bit	Attr	Default	Description
31:0	RW	0	DATA 32-bit window into the indirectly-addressed pattern buffer register space.

4.9.9 MC_TEST_PAT_IS

Memory test pattern inversion selection register.

Device: 3 Function: 4 Offset: BCh Access as a DWord			
Bit	Attr	Default	Description
31:8	RO	0	<i>Reserved</i>
7:0	RW	1	LANE_INVERT Per-lane selection of normal or inverted pattern

4.9.10 MC_TEST_PAT_DCD

Memory test DC drive register.

Device: 3 Function: 4 Offset: C0h Access as a DWord			
Bit	Attr	Default	Description
31:8	RO	0	<i>Reserved</i>
7:0	RW	0	LANE_DRIVE_DC Per-lane selection of DC pattern



4.9.11 MC_TEST_EP_SCCTL

Memory test electrical parameter scan chain control register.

Device: 3 Function: 4 Offset: F8h Access as a DWord			
Bit	Attr	Default	Description
31	RW1S	0	SCAN_READ Perform a scan chain read.
30	RW1S	0	SCAN_WRITE Perform a scan chain write.
29:16	RO	0	<i>Reserved</i>
15:0	RW	0	SCAN_OFFSET Shift count to perform upon next shift command.

4.9.12 MC_TEST_EP_SCD

Memory test electrical parameter scan chain data register.

Device: 3 Function: 4 Offset: FCh Access as a DWord			
Bit	Attr	Default	Description
31:0	RW	0	DATA Contains the data written to or read from the scan chain.



4.10 Integrated Memory Controller Channel Control Registers

4.10.1 MC_CHANNEL_0_DIMM_RESET_CMD MC_CHANNEL_1_DIMM_RESET_CMD

Integrated Memory Controller DIMM reset command register. This register is used to sequence the reset signals to the DIMMs.

Device: 4, 5 Function: 0 Offset: 50h Access as a DWord			
Bit	Attr	Default	Description
31:3	RO	0	<i>Reserved</i>
2	RW	0	BLOCK_CKE When set, CKE will be forced to be deasserted.
1	RW	0	ASSERT_RESET When set, Reset will be driven to the DIMMs.
0	WO	0	RESET Reset the DIMMs. Setting this bit will cause the Integrated Memory Controller DIMM Reset state machine to sequence through the reset sequence using the parameters in MC_DIMM_INIT_PARAMS.



4.10.2 MC_CHANNEL_0_DIMM_INIT_CMD MC_CHANNEL_1_DIMM_INIT_CMD

Integrated Memory Controller DIMM initialization command register. This register is used to sequence the channel through the physical layer training required for DDR.

Device: 4, 5 Function: 0 Offset: 54h Access as a DWord			
Bit	Attr	Default	Description
31:18	RO	0	<i>Reserved</i>
17	WO	0	ASSERT_CKE When set, all CKE will be asserted. Write a 0 to this bit to stop the init block from driving CKE. This bit has no effect once INIT_DONE is set. This bit must not be asserted during initialization for S3 resume.
16	RW	0	DO_RCOMP When set, an RCOMP will be issued to the rank specified in the RANK field.
15	RW	0	DO_ZOCL When set, a ZOCL will be issued to the rank specified in the RANK field.
14	RW	0	WRDQDQS_MASK When set, the Write DQ-DQS training will be skipped.
13	RW	0	WRLEVEL_MASK When set, the Write Levelization step will be skipped.
12	RW	0	RDDQDQS_MASK When set, the Read DQ-DQS step will be skipped.
11	RW	0	RCVEN_MASK When set, the RCVEN step will be skipped.
10	WO	0	RESET_FIFOS When set, the TX and RX FIFO pointers will be reset at the next BCLK edge. The Bubble Generators will also be reset.
9	RW	0	IGNORE_RX When set, the read return datapath will ignore all data coming from the RX FIFOS. This is done by gating the early valid bit.
8	RW	0	STOP_ON_FAIL When set along with the AUTORESETDIS not being set, the phyinit FSM will stop if a step has not completed after timing out.
7:5	RW	0	RANK The rank currently being tested. The PhyInit FSM must be sequenced for every rank present in the channel. The rank value is set to the rank being trained.
4:2	RW	0	NXT_PHYINIT_STATE Set to sequence the physical layer state machine. 000 = IDLE 001 = RD DQ-DQS 010 = RcvEn Bitlock 011 = Write Level 100 = WR DQ-DQS.
1	RW	0	AUTODIS Disables the automatic training where each step is automatically incremented. When set, the physical layer state machine must be sequenced with software. The training FSM must be sequenced using the NXT_PHYINIT_STATE field.
0	WO	0	TRAIN Cycle through the training sequence for the rank specified in the RANK field.

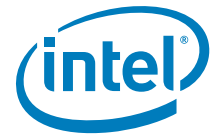

4.10.3 MC_CHANNEL_0_DIMM_INIT_PARAMS MC_CHANNEL_1_DIMM_INIT_PARAMS

Initialization sequence parameters are stored in this register. Each field is 2ⁿ count.

Device: 4, 5 Function: 0 Offset: 58h Access as a DWord			
Bit	Attr	Default	Description
31:27	RO	0	Reserved
26	RV	0	Reserved
25	RV	0	Reserved
24	RV	0	Reserved
23	RV	0	Reserved
22	RV	0	Reserved
21:17	RW	15	WRDQDQS_DELAY Specifies the delay in DCLKs between reads and writes for WRDQDQS training.
16	RW	0	WRLEVEL_DELAY Specifies the delay used between write CAS indications for write leveling training. 0 = 16 DCLKs 1 = 32 DCLKs
15	RV	0	Reserved
14:10	RW	0	PHY_FSM_DELAY Global timer used for bounding the physical layer training. If the timer expires, the FSM will go to the next step and the counter will be reloaded with PHY_FSM_DELAY value. Units are 2 ⁿ dclk.
9:5	RW	0	BLOCK_CKE_DELAY Delay in ns from when clocks and command are valid to the point CKE is allowed to be asserted. Units are in 2 ⁿ uclk.
4:0	RW	0	RESET_ON_TIME Reset will be asserted for the time specified. Units are 2 ⁿ Uclk.

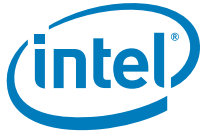

4.10.4 MC_CHANNEL_0_DIMM_INIT_STATUS MC_CHANNEL_1_DIMM_INIT_STATUS

The initialization state is stored in this register. This register is cleared on a new training command.

Device: 4, 5 Function: 0 Offset: 5Ch Access as a DWord			
Bit	Attr	Default	Description
31:10	RO	0	<i>Reserved</i>
9	RO	0	RCOMP_CMPLT When set, indicates that RCOMP command has complete. This bit is cleared by hardware on command issuance and set once the command is complete.
8	RO	0	INIT_CMPLT This bit is cleared when a new training command is issued. It is set once the sequence is complete regardless of whether all steps passed or not.
7	RO	0	ZQCL_CMPLT When set, indicates that ZQCL command has completed. This bit is cleared by hardware on command issuance and set once the command is complete.
6	RO	0	WR_DQ_DQS_PASS Set after a training command when the Write DQ-DQS training step passes. The bit is cleared by hardware when a new training command is sent.
5	RO	0	WR_LEVEL_PASS Set after a training command when the write leveling training step passes. The bit is cleared by hardware when a new training command is sent.
4	RO	0	RD_RCVEN_PASS Set after a training command when the Read Receive Enable training step passes. The bit is cleared by hardware when a new training command is sent.
3	RO	0	RD_DQ_DQS_PASS Set after a training command when the Read DQ-DQS training step passes. The bit is cleared by hardware when a new training command is sent.
2:0	RO	0	PHYFSMSTATE The current state of the top level training FSM. 000 = IDLE 001 = RD DQ-DQS 010 = RcvEn Bitlock 011 = Write Level 100 = WR DQ-DQS

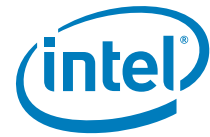

4.10.5 MC_CHANNEL_0_DDR3CMD MC_CHANNEL_1_DDR3CMD

DDR3 Configuration Command. This register is used to issue commands to the DIMMs such as MRS commands. The register is used by setting one of the *_VALID bits along with the appropriate address and destination RANK. The command is then issued directly to the DIMM. Care must be taken in using this register as there is no enforcement of timing parameters related to the action taken by a DDR3CMD write. This register has no effect after MC_CONROL>INIT_DONE is set.

Bit	Attr	Default	Description
Device: 4, 5 Function: 0 Offset: 60h Access as a DWord			
31:29	RO	0	<i>Reserved</i>
28	RW	0	PRECHARGE_VALID Indicates current command is for a precharge command.
27	RW	0	ACTIVATE_VALID Indicates current command is for an activate command.
26	RW	0	<i>Reserved</i>
25	RW	0	WR_VALID Indicates current command is for a write CAS. Bit is cleared by hardware on issuance.
24	RW	0	RD_VALID Indicates current command is for a read CAS. Bit is cleared by hardware on issuance.
23	RW	0	MRS_VALID Indicates current command is an MRS command. Bit is cleared by hardware on issuance.
22:20	RW	0	RANK Destination rank for command.
19:16	RW	0	MRS_BA Bank address portion of the MRS command. The MRS_BA field corresponds to BA[3:0].
15:0	RW	0	MRS_ADDR Address used by the MRS command.

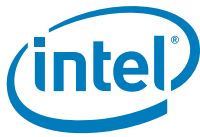

4.10.6 MC_CHANNEL_0_REFRESH_THROTTLE_SUPPORT MC_CHANNEL_1_REFRESH_THROTTLE_SUPPORT

This register supports Self Refresh and Thermal Throttle functions.

Device: 4, 5 Function: 0 Offset: 68h Access as a DWord			
Bit	Attr	Default	Description
31:4	RO	0	<i>Reserved</i>
3:2	RW	0	INC_ENTERPWRDWN_RATE Powerdown rate will be increased during thermal throttling based on the following configurations. 00 = tRANKIDLE (Default) 01 = 16 10 = 24 11 = 32
1	RW	0	DIS_OP_REFRESH When set the refresh engine will not issue opportunistic refresh. Setting this bit when either the MC_DIMM_INIT_PARAMS.QUAD_RANK_PRESENT bit or the MC_DIMM_INIT_PARAMS.THREE_DIMMS_PRESENT bit is set will prevent entry into self refresh
0	RW	0	ASR_PRESENT When set, this bit indicates DRAMs on this channel can support Automatic Self Refresh. If the DRAM is not supporting ASR (Auto Self Refresh), then Self Refresh entry will be delayed until the temperature is below the 2x refresh temperature.

4.10.7 MC_CHANNEL_0_MRS_VALUE_0_1 MC_CHANNEL_1_MRS_VALUE_0_1

The initial MRS register values for MR0, and MR1 can be specified in this register. These values are used for the automated MRS writes used as a part of the training FSM. The remaining values of the MRS register must be specified here.

Device: 4, 5 Function: 0 Offset: 70h Access as a DWord			
Bit	Attr	Default	Description
31:16	RW	0	MR1 The values to write to MR1 for A15:A0.
15:0	RW	0	MRO The values to write to MR0 for A15:A0.

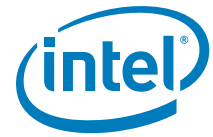

4.10.8 MC_CHANNEL_0_MRS_VALUE_2 MC_CHANNEL_1_MRS_VALUE_2

The initial MRS register values for MR2. The RC fields do not need to be programmed if the address inversion and 3T/1T transitions are disabled.

Device: 4, 5 Function: 0 Offset: 74h Access as a DWord			
Bit	Attr	Default	Description
31:24	RO	0	<i>Reserved</i>
23:20	RW	0	<i>Reserved</i>
19:16	RW	0	<i>Reserved</i>
15:0	RW	0	MR2 The values to write to MR2 for A15:A0.



4.10.9 MC_CHANNEL_0_RANK_PRESENT MC_CHANNEL_1_RANK_PRESENT

This register provides the rank present vector.

Device: 4, 5 Function: 0 Offset: 7Ch Access as a DWord			
Bit	Attr	Default	Description
31:8	RO	0	Reserved
7:0	RW	0	RANK_PRESENT Vector that represents the ranks that are present. Each bit represents a logical rank. When two or fewer DIMMs are present, [3:0] represents the four possible ranks in DIMM0 and [7:4] represents the ranks that are possible in DIMM1. When three DIMMs are present, then the following applies: [1:0] represents ranks 1:0 in Slot 0 [3:2] represents ranks 3:2 in Slot 1 [5:4] represents ranks 5:4 in Slot 2 [7:6] represents ranks 7:6 in Slot 3

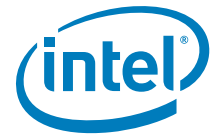

4.10.10 MC_CHANNEL_0_RANK_TIMING_A MC_CHANNEL_1_RANK_TIMING_A

This register contains parameters that specify the rank timing used. All parameters are in DCLK.

Device: 4, 5 Function: 0 Offset: 80h Access as a DWord			
Bit	Attr	Default	Description
31:27	RO	0	<i>Reserved</i>
28:26	RW	0	tddWrTRd Minimum delay between a write followed by a read to different DIMMs. 000 = 1 001 = 2 010 = 3 011 = 4 100 = 5 101 = 6 110 = 7 111 = 8
25:23	RW	0	tdrWrTRd Minimum delay between a write followed by a read to different ranks on the same DIMM. 000 = 1 001 = 2 010 = 3 011 = 4 100 = 5 101 = 6 110 = 7 111 = 8
22:19	RW	0	tsrWrTRd Minimum delay between a write followed by a read to the same rank. 0000 = 10 0001 = 11 0010 = 12 0011 = 13 0100 = 14 0101 = 15 0110 = 16 0111 = 17 1000 = 18 1001 = 19 1010 = 20 1011 = 21 1100 = 22
18:15	RW	0	tddRdTWr Minimum delay between Read followed by a write to different DIMMs. 000 = 2 001 = 3 010 = 4 011 = 5 100 = 6 101 = 7 110 = 8 111 = 9



Device: 4, 5 Function: 0 Offset: 80h Access as a DWord			
Bit	Attr	Default	Description
14:11	RW	0	tdrRdTWr Minimum delay between Read followed by a write to different ranks on the same DIMM. 000 = 2 001 = 3 010 = 4 011 = 5 100 = 6 101 = 7 110 = 8 111 = 9
10:7	RW	0	tsrRdTWr Minimum delay between Read followed by a write to the same rank. 000 = RSVD 001 = RSVD 010 = RSVD 011 = 5 100 = 6 101 = 7 110 = 8 111 = 9
6:4	RW	0	tddRdTRd Minimum delay between reads to different DIMMs. 000 = 2 001 = 3 010 = 4 011 = 5 100 = 6 101 = 7 110 = 8 111 = 9
3:1	RW	0	tdrRdTRd Minimum delay between reads to different ranks on the same DIMM. 000 = 2 001 = 3 010 = 4 011 = 5 100 = 6 101 = 7 110 = 8 111 = 9
0	RW	0	tsrRdTRd Minimum delay between reads to the same rank. 0 = 4 1 = 6

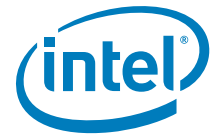

4.10.11 MC_CHANNEL_0_RANK_TIMING_B MC_CHANNEL_1_RANK_TIMING_B

This register contains parameters that specify the rank timing used. All parameters are in DCLK.

Device: 4, 5 Function: 0 Offset: 84h Access as a DWord			
Bit	Attr	Default	Description
31:21	RO	0	<i>Reserved</i>
20:16	RW	0	B2B_CAS_DELAY This field controls the delay between CAS commands in DCLKS. The minimum spacing is 4 DCLKS. Values below 3 have no effect. A value of 0 disables the logic. Setting the value between 3-31 also spaces the read data by 0-29 DCLKS. The value entered is one less than the spacing required, that is, a spacing of 5 DCLKS between CAS commands (or 1 DCLK on the read data) requires a setting of 4.
15:13	RW	0	tddWrTWr Minimum delay between writes to different DIMMs. 000 = 2 001 = 3 010 = 4 011 = 5 100 = 6 101 = 7 110 = 8 111 = 9
12:10	RW	0	tdrWrTWr Minimum delay between writes to different ranks on the same DIMM. 000 = 2 001 = 3 010 = 4 011 = 5 100 = 6 101 = 7 110 = 8 111 = 9
9	RW	0	tsrWrTWr Minimum delay between writes to the same rank. 0 = 4 1 = 6
8:6	RW	0	tRRD Specifies the minimum time between activate commands to the same rank.
5:0	RW	0	tFAW Four Activate Window. Specifies the time window in which four activates are allowed the same rank.



4.10.12 MC_CHANNEL_0_BANK_TIMING MC_CHANNEL_1_BANK_TIMING

This register contains parameters that specify the bank timing parameters. These values are in DCLK. The values in these registers are encoded where noted. All of these values apply to commands to the same rank only.

Device: 4, 5 Function: 0 Offset: 88h Access as a DWord			
Bit	Attr	Default	Description
31:22	RO	0	<i>Reserved</i>
21:17	RW	0	tWTPr: Minimum Write CAS to Precharge command delay.
16:13	RW	0	tRTPr: Minimum Read CAS to Precharge command delay.
12:9	RW	0	tRCD: Minimum delay between Activate and CAS commands.
8:4	RW	0	tRAS: Minimum delay between Activate and Precharge commands.
3:0	RW	0	tRP: Minimum delay between Precharge command and Activate command.

4.10.13 MC_CHANNEL_0_REFRESH_TIMING MC_CHANNEL_1_REFRESH_TIMING

This register contains parameters that specify the refresh timings. Units are in DCLK.

Device: 4, 5 Function: 0 Offset: 8Ch Access as a DWord			
Bit	Attr	Default	Description
31:30	RO	0	<i>Reserved</i>
29:19	RW	0	tTHROT_OPPREF The minimum time between two opportunistic refreshes. The ranges should be within tRFC/3 to 4*tRFC. Zero is an invalid encoding. A value of 1 should be programmed to disable the throttling of opportunistic refreshes. By setting this field to tRFC, current to a single DIMM can be limited to that required to support this scenario without significant performance impact: <ul style="list-style-type: none"> • 8 panic refreshes in tREFI to one rank • 1 opportunistic refresh every tRFC to another rank • full bandwidth delivered by the third and fourth ranks Platforms that can supply peak currents to the DIMMs should disable opportunistic refresh throttling for max performance.
18:9	RW	0	tREFI_8 Average periodic refresh interval divided by 8.
8:0	RW	0	tRFC Delay between the refresh command and an activate or refresh command.

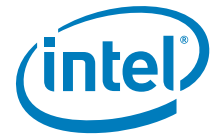

4.10.14 MC_CHANNEL_0_CKE_TIMING MC_CHANNEL_1_CKE_TIMING

This register contains parameters that specify the CKE timings. All units are in DCLK.

Device: 4, 5 Function: 0 Offset: 90h Access as a DWord			
Bit	Attr	Default	Description
31:24	RW	0	tRANKIDLE Rank will go into powerdown after it has been idle for the specified number of DCLKs. tRANKIDLE covers max(txxxPDEN). Minimum value is tWRAPDEN. If CKE is being shared between ranks then both ranks must be idle for this amount of time. A Power Down Entry command will be requested for a rank after this number of DCLKs if no request to the rank is in the MC.
23:21	RW	0	tXP Minimum delay from exit power down with DLL and any valid command. Exit Precharge Power Down with DLL frozen to commands not requiring a locked DLL. Slow exit precharge powerdown is not supported.
20:11	RW	0	tXSDLL Minimum delay between the exit of self refresh and commands that require a locked DLL.
10:3	RW	0	tXS Minimum delay between the exit of self refresh and commands not requiring a DLL.
2:0	RW	0	tCKE CKE minimum pulse width.

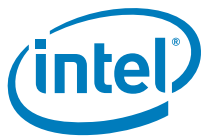

4.10.15 MC_CHANNEL_0_ZQ_TIMING MC_CHANNEL_1_ZQ_TIMING

This register contains parameters that specify ZQ timing. All units are DCLK unless otherwise specified. The register encodings are specified where applicable.

Device: 4, 5 Function: 0 Offset: 94h Access as a DWord			
Bit	Attr	Default	Description
31	RO	0	<i>Reserved</i>
30	RW	1	Parallel_ZQ Enable ZQ calibration to different ranks in parallel.
29	RW	1	tZQenable Enable the issuing of periodic ZQCS calibration commands.
28:8	RW	16410	ZQ_Interval Nominal interval between periodic ZQ calibration in increments of tREFI.
7:5	RW	4	tZQCS Specifies ZQCS cycles in increments of 16. This is the minimum delay between ZQCS and any other command. This register should be programmed to at least 64/16=4='100' to conform to the DDR3 specification.
4:0	RW	0	tZQInit Specifies ZQInit cycles in increments of 32. This is the minimum delay between ZQCL and any other command. This register should be programmed to at least 512/32=16='10000' to conform to the DDR3 specification.

4.10.16 MC_CHANNEL_0_RCOMP_PARAMS MC_CHANNEL_1_RCOMP_PARAMS

This register contains parameters that specify Rcomp timings.

Device: 4, 5 Function: 0 Offset: 98h Access as a DWord			
Bit	Attr	Default	Description
31:17	RO	0	<i>Reserved</i>
16	RW	0	RCOMP_EN. Enable Rcomp When set, the Integrated Memory Controller will do the programmed blocking of requests and send indications.
15:10	RW	2	RCOMP_CMD_DCLK Delay from the start of an RCOMP command blocking period in which the command rcomp update is done. Program this field to 15 for all configurations.
9:4	RW	9	RCOMP_LENGTH Number of Dclks during which all commands are blocked for an RCOMP update. Data RCOMP update is done on the last DCLK of this period. Program this field to 31 for all configurations.
3:0	RW	0	RCOMP_INTERVAL Duration of interval between Rcomp in increments of tREFI. Register value is tREFI-1. For example a setting of 0 will produce an interval of tREFI.

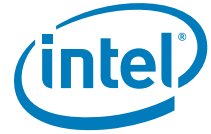

4.10.17 MC_CHANNEL_0_ODT_PARAMS1 MC_CHANNEL_1_ODT_PARAMS1

This register contains parameters that specify ODT timings. All values are in DCLK.

Device: 4, 5 Function: 0 Offset: 9Ch Access as a DWord			
Bit	Attr	Default	Description
31:27	RO	0	<i>Reserved</i>
26:24	RW	0	TAOFD ODT turn off delay.
23:20	RW	6	MCODT_DURATION Controls the duration of MC ODT activation. $BL/2 + 2$.
19:16	RW	4	MCODT_DELAY Controls the delay from Rd CAS to MC ODT activation. This value is $t_{CAS}-1$.
15:12	RW	5	ODT_RD_DURATION Controls the duration of Rd ODT activation. This value is $BL/2 + 2$.
11:8	RW	0	ODT_RD_DELAY Controls the delay from Rd CAS to ODT activation. This value is $t_{CAS}-t_{WL}$.
7:4	RW	5	ODT_WR_DURATION Controls the duration of Wr ODT activation. value is $BL/2 + 2$.
3:0	RW	0	ODT_WR_DELAY Controls the delay from Wr CAS to ODT activation. This value is always 0.

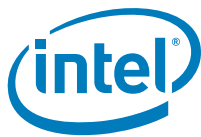

4.10.18 MC_CHANNEL_0_ODT_PARAMS2 MC_CHANNEL_1_ODT_PARAMS2

This register contains parameters that specify Forcing ODT on Specific ranks.

Device: 4, 5 Function: 0 Offset: A0h Access as a DWord			
Bit	Attr	Default	Description
31:10	RO	0	<i>Reserved</i>
9	RW	0	MCODT_Writes. Drive MC ODT on reads and writes.
8	RW	0	FORCE_MCODT. Force MC ODT to always be asserted.
7	RW	0	FORCE_ODT7. Force ODT for Rank 7 to always be asserted.
6	RW	0	FORCE_ODT6. Force ODT for Rank 6 to always be asserted.
5	RW	0	FORCE_ODT5. Force ODT for Rank 5 to always be asserted.
4	RW	0	FORCE_ODT4. Force ODT for Rank 4 to always be asserted.
3	RW	0	FORCE_ODT3. Force ODT for Rank 3 to always be asserted.
2	RW	0	FORCE_ODT2. Force ODT for Rank 2 to always be asserted.
1	RW	0	FORCE_ODT1. Force ODT for Rank 1 to always be asserted.
0	RW	0	FORCE_ODT0. Force ODT for Rank 0 to always be asserted.

4.10.19 MC_CHANNEL_0_ODT_MATRIX_RANK_0_3_RD MC_CHANNEL_1_ODT_MATRIX_RANK_0_3_RD

This register contains the ODT activation matrix for RANKS 0 to 3 for Reads.

Device: 4, 5 Function: 0 Offset: A4h Access as a DWord			
Bit	Attr	Default	Description
31:24	RW	1	ODT_RD3. ODT values for all 8 Ranks when reading Rank 3.
23:16	RW	1	ODT_RD2. ODT values for all 8 Ranks when reading Rank 2.
15:8	RW	4	ODT_RD1. ODT values for all 8 Ranks when reading Rank 1.
7:0	RW	4	ODT_RD0. ODT values for all 8 Ranks when reading Rank 0.

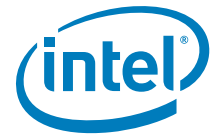

4.10.20 MC_CHANNEL_0_ODT_MATRIX_RANK_4_7_RD MC_CHANNEL_1_ODT_MATRIX_RANK_4_7_RD

This register contains the ODT activation matrix for RANKS 4 to 7 for Reads.

Device: 4, 5 Function: 0 Offset: A8h Access as a DWord			
Bit	Attr	Default	Description
31:24	RW	1	ODT_RD3 . ODT values for all 8 Ranks when reading Rank 7.
23:16	RW	1	ODT_RD2 . ODT values for all 8 Ranks when reading Rank 6.
15:8	RW	4	ODT_RD1 . ODT values for all 8 Ranks when reading Rank 5.
7:0	RW	4	ODT_RD0 . ODT values for all 8 Ranks when reading Rank 4.

4.10.21 MC_CHANNEL_0_ODT_MATRIX_RANK_0_3_WR MC_CHANNEL_1_ODT_MATRIX_RANK_0_3_WR

This register contains the ODT activation matrix for RANKS 0 to 3 for Writes.

Device: 4, 5 Function: 0 Offset: ACh Access as a DWord			
Bit	Attr	Default	Description
31:24	RW	9	ODT_WR3 . ODT values for all 4 Ranks when writing to Rank 3.
23:16	RW	5	ODT_WR2 . ODT values for all 4 Ranks when writing to Rank 2.
15:8	RW	6	ODT_WR1 . ODT values for all 4 Ranks when writing to Rank 1.
7:0	RW	5	ODT_WR0 . ODT values for all 4 Ranks when writing to Rank 0.

4.10.22 MC_CHANNEL_0_ODT_MATRIX_RANK_4_7_WR MC_CHANNEL_1_ODT_MATRIX_RANK_4_7_WR

This register contains the ODT activation matrix for RANKS 4 to 7 for Writes.

Device: 4, 5 Function: 0 Offset: B0h Access as a DWord			
Bit	Attr	Default	Description
31:24	RW	9	ODT_WR7 . ODT values for all 4 ranks when writing to Rank7.
23:16	RW	5	ODT_WR6 . ODT values for all 4 ranks when writing to Rank6.
15:8	RW	6	ODT_WR5 . ODT values for all 4 ranks when writing to Rank5.
7:0	RW	5	ODT_WR4 . ODT values for all 4 ranks when writing to Rank4.



4.10.23 MC_CHANNEL_0_WAQ_PARAMS MC_CHANNEL_1_WAQ_PARAMS

This register contains parameters that specify settings for the Write Address Queue.

Device: 4, 5 Function: 0 Offset: B4h Access as a DWord			
Bit	Attr	Default	Description
31:30	RO	0	<i>Reserved</i>
29:25	RW	6	PRECASWRTHRESHOLD Threshold above which Medium-Low Priority reads cannot PRE-CAS write requests.
24:20	RW	31	PARTWRTHRESHOLD Threshold used to raise the priority of underfill requests in the scheduler. Set to 31 to disable.
19:15	RW	31	ISOCEXITTHRESHOLD Write Major Mode ISOC Exit Threshold. When the number of writes in the WAQ drops below this threshold, the MC will exit write major mode in the presence of a read.
14:10	RW	31	ISOCENTRYTHRESHOLD Write Major Mode ISOC Entry Threshold. When the number of writes in the WAQ exceeds this threshold, the MC will enter write major mode in the presence of a read.
9:5	RW	22	WMENTRYTHRESHOLD Write Major Mode Entry Threshold. When the number of writes in the WAQ exceeds this threshold, the MC will enter write major mode.
4:0	RW	22	WMEXITTHRESHOLD Write Major Mode Exit Threshold. When the number of writes in the WAQ drop below this threshold, the MC will exit write major mode.

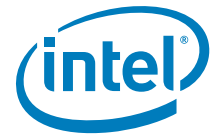

4.10.24 MC_CHANNEL_0_SCHEDULER_PARAMS MC_CHANNEL_1_SCHEDULER_PARAMS

These are the parameters used to control parameters within the scheduler.

Device: 4, 5 Function: 0 Offset: B8h Access as a DWord			
Bit	Attr	Default	Description
31:14	RO	0	<i>Reserved</i>
13	RW	0	DDR_CLK_TRISTATE_DISABLE . When set to 0, DDR clock drivers will always be enabled.
12	RW	0	CS_ODT_TRISTATE_DISABLE . When set to 0, CS and ODT drivers will always be enabled.
11	RW	0	FLOAT_EN When set to 1, the address and command lines will float to save power when commands are not being sent out.
10:6	RW	7	PRECASRDTHRESHOLD Threshold above which Medium-Low Priority reads can PRE-CAS write requests.
5	RW	0	DISABLE_ISOC_RBC_RESERVE When set to 1, this bit will prevent any RBC's from being reserved for ISOC.
4	RW	0	ENABLE3N. Enable 3n Timing
3	RW	0	ENABLE2N. Enable 2n Timing
2:0	RW	0	PRIORITYCOUNTER Upper 3 MSB of 8-bit priority time out counter.

4.10.25 MC_CHANNEL_0_MAINTENANCE_OPS MC_CHANNEL_1_MAINTENANCE_OPS

This register enables various maintenance operations such as Refreshes, ZQ, RCOMP, and so forth.

Device: 4, 5 Function: 0 Offset: BCh Access as a DWord			
Bit	Attr	Default	Description
31:13	RO	0	<i>Reserved</i>
12:0	RW	0	MAINT_CNTR Value to be loaded in the maintenance counter. This counter sequences the rate to Refreshes, ZQ, RCOMP. It should be set to 7800/DCLKperiodInNS. The value of 0 is invalid.

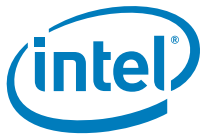

4.10.26 MC_CHANNEL_0_TX_BG_SETTINGS MC_CHANNEL_1_TX_BG_SETTINGS

These are the parameters used to set the Start Scheduler for TX clock crossing. This is used to send commands to the DIMMs.

The NATIVE RATIO is UCLK multiplier of BCLK = U

ALIEN RATIO is DCLK multiplier of BCLK = D

PIPE DEPTH = 8 UCLK (design dependent variable)

MIN SEP DELAY = 670 ps (design dependent variable, Internally this is logic delay of FIFO + clock skew between U and D)

TOTAL EFFECTIVE DELAY = PIPE DEPTH * UCLK PERIOD in ps + MIN SEP DELAY

DELAY FRACTION = (TOTAL EFFECTIVE DELAY * D) / (UCLK PERIOD in ps * G.C.D(U,D))

Determine OFFSET MULTIPLE using the equation

FLOOR ((OFFSET MULTIPLE + 1) / G.C.D (U,D)) > DELAY FRACTION

OFFSET VALUE = MOD (OFFSET MULTIPLE, U) ≤ Final answer for OFFSET MULTIPLE

Device: 4, 5 Function: 0 Offset: C0h Access as a DWord			
Bit	Attr	Default	Description
31:17	RO	0	<i>Reserved</i>
23:16	RW	2	OFFSET TX offset setting.
15:8	RW	1	ALIENRATIO Dclk ratio to BCLK. TX Alien Ratio setting.
7:0	RW	4	NATIVERATIO Uclk ratio to BCLK. TX Native Ratio setting.

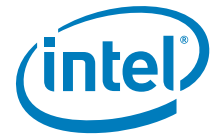

4.10.27 MC_CHANNEL_0_RX_BGF_SETTINGS MC_CHANNEL_1_RX_BGF_SETTINGS

These are the parameters used to set the Rx clock crossing BGF.

Device: 4, 5 Function: 0 Offset: C8h Access as a DWord			
Bit	Attr	Default	Description
31:27	RO	0	<i>Reserved</i>
26:24	RW	2	PTRSEP RX FIFO pointer separation settings. THIS FIELD IS NOT USED BY HARDWARE. RX Pointer separation can be modified using the round trip setting (larger value causes a larger pointer separation).
23:16	RW	0	OFFSET RX offset setting.
15:8	RW	1	ALIENRATIO Qclk to BCLK ratio. RX Alien Ratio setting.
7:0	RW	2	NATIVERATIO Uclk to BCLK ratio. RX Native Ratio setting.

4.10.28 MC_CHANNEL_0_EW_BGF_SETTINGS MC_CHANNEL_1_EW_BGF_SETTINGS

These are the parameters used to set the early warning RX clock crossing BGF.

Device: 4, 5 Function: 0 Offset: CCh Access as a DWord			
Bit	Attr	Default	Description
31:16	RO	0	<i>Reserved</i>
15:8	RW	1	ALIENRATIO Dclk to Bclk ratio. Early warning Alien Ratio setting.
7:0	RO	0	<i>Reserved</i>



4.10.29 MC_CHANNEL_0_EW_BGF_OFFSET_SETTINGS MC_CHANNEL_1_EW_BGF_OFFSET_SETTINGS

These are the parameters to set the early warning RX clock crossing BGF.

Device: 4, 5 Function: 0 Offset: D0h Access as a DWord			
Bit	Attr	Default	Description
31:16	RO	0	Reserved
15:8	RW	2	EVENOFFSET Early warning even offset setting.
7:0	RW	0	ODDOFFSET Early warning odd offset setting.

4.10.30 MC_CHANNEL_0_ROUND_TRIP_LATENCY MC_CHANNEL_1_ROUND_TRIP_LATENCY

These are the parameters to set the early warning RX clock crossing the Bubble Generator FIFO (BGF) used to go between different clocking domains. These settings provide the gearing necessary to make that clock crossing.

Device: 4, 5 Function: 0 Offset: D4h Access as a DWord			
Bit	Attr	Default	Description
31:8	RO	0	Reserved
7:0	RW	0	ROUND_TRIP_LATENCY Round trip latency for reads. Units are in UCLK. This register must be programmed with the appropriate time for read data to be returned from the pads after a READ CAS is sent to the DIMMs.

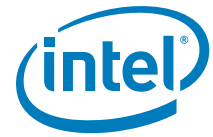

4.10.31 MC_CHANNEL_0_PAGETABLE_PARAMS1 MC_CHANNEL_1_PAGETABLE_PARAMS1

These are the parameters used to control parameters for page closing policies.

Device: 4, 5 Function: 0 Offset: D8h Access as a DWord			
Bit	Attr	Default	Description
31:16	RO	0	<i>Reserved</i>
15:8	RW	0	REQUESTCOUNTER Upper 8 MSBs of a 12-bit counter. This counter determines the window over which the page close policy is evaluated.
7:0	RW	0	ADAPTIVETIMEOUTCOUNTER Upper 8 MSBs of a 12-bit counter. This counter adapts the interval between assertions of the page close flag. For a less aggressive page close, the length of the count interval is increased and vice versa for a more aggressive page close policy.

4.10.32 MC_CHANNEL_0_PAGETABLE_PARAMS2 MC_CHANNEL_1_PAGETABLE_PARAMS2

These are the parameters used to control parameters for page closing policies.

Device: 4, 5 Function: 0 Offset: DCh Access as a DWord			
Bit	Attr	Default	Description
31:28	RO	0	<i>Reserved</i>
27	RW	0	ENABLEADAPTIVEPAGECLOSE When set, enables Adaptive Page Closing.
26:18	RW	0	MINPAGECLOSELIMIT Upper 9 MSBs of a 13-bit threshold limit. When the mistake counter falls below this threshold, a less aggressive page close interval (larger) is selected.
17:9	RW	0	MAXPAGECLOSELIMIT Upper 9 bits of a 13-bit threshold limit. When the mistake counter exceeds this threshold, a more aggressive page close interval (smaller) is selected.
8:0	RW	0	MISTAKECOUNTER Upper 9 MSBs of a 12-bit counter. This counter adapts the interval between assertions of the page close flag. For a less aggressive page close, the length of the count interval is increased and vice versa for a more aggressive page close policy.

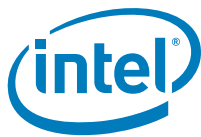

4.10.33 MC_TX_BG_CMD_DATA_RATIO_SETTINGS_CHO MC_TX_BG_CMD_DATA_RATIO_SETTINGS_CH1

Channel Bubble Generator ratios for CMD and DATA.

Device: 4, 5 Function: 0 Offset: E0h Access as a DWord			
Bit	Attr	Default	Description
31:16	RO	0	<i>Reserved</i>
15:8	RW	0	ALIENRATIO. DCLK to BCLK ratio.
7:0	RW	0	NATIVERATIO. UCLK to BCLK ratio.

4.10.34 MC_TX_BG_CMD_OFFSET_SETTINGS_CHO MC_TX_BG_CMD_OFFSET_SETTINGS_CH1

Integrated Memory Controller Channel Bubble Generator Offsets for CMD FIFO. The Data command FIFOs share the settings for channel 0 across all three channels. The register in Channel 0 must be programmed for all configurations.

Device: 4, 5 Function: 0 Offset: E4h Access as a DWord			
Bit	Attr	Default	Description
31:10	RO	0	<i>Reserved</i>
9:8	RW	0	PTROFFSET. IFO pointer offset.
7:0	RW	0	BGOFFSET. BG offset.

4.10.35 MC_TX_BG_DATA_OFFSET_SETTINGS_CHO MC_TX_BG_DATA_OFFSET_SETTINGS_CH1

Integrated Memory Controller Channel Bubble Generator Offsets for DATA FIFO.

Device: 4, 5 Function: 0 Offset: E8h Access as a DWord			
Bit	Attr	Default	Description
31:17	RO	0	<i>Reserved</i>
16:14	RW	0	RDPTROFFSET. Read FIFO pointer offset.
13:10	RW	0	WRTPTROFFSET. Write FIFO pointer offset.
9:8	RW	0	PTROFFSET. FIFO pointer offset.
7:0	RW	0	BGOFFSET. BG offset.

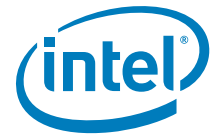

4.11 Integrated Memory Controller Channel Address Registers

4.11.1 MC_DOD_CHO_0 MC_DOD_CHO_1

Channel 0 DIMM Organization Descriptor Register.

Device: 4 Function: 1 Offset: 48h, 4Ch, 50h, 54h Access as a DWord			
Bit	Attr	Default	Description
31:13	RO	0	<i>Reserved</i>
12:10	RW	0	RANKOFFSET Rank Offset for calculating RANK. This corresponds to the first logical rank on the DIMM. The rank offset is always programmed to 0 for the DIMM 0 DOD registers. (DIMM 0 rank offset is always 0.) DIMM 1 DOD rank offset is 4 for two DIMMs per channel.
9	RW	0	DIMMPRESENT . DIMM slot is populated.
8:7	RW	0	NUMBANK This field defines the number of (real, not shadow) banks on these DIMMs. 00 = Four-banked 01 = Eight-banked 10 = Sixteen-banked
6:5	RW	0	NUMRANK . Number of Ranks This field defines the number of ranks on these DIMMs. 00 = Single Ranked 01 = Double Ranked 10 = <i>Reserved</i>
4:2	RW	0	NUMROW . Number of Rows This field defines the number of rows within these DIMMs. 000 = 2 ¹² Rows 001 = 2 ¹³ Rows 010 = 2 ¹⁴ Rows 011 = 2 ¹⁵ Rows 100 = 2 ¹⁶ Rows
1:0	RW	0	NUMCOL . Number of Columns This field defines the number of columns within on these DIMMs. 00 = 2 ¹⁰ columns 01 = 2 ¹¹ columns 10 = 2 ¹² columns 11 = RSVD



4.11.2 MC_DOD_CH1_0 MC_DOD_CH1_1

Channel 1 DIMM Organization Descriptor Register.

Device: 5 Function: 1 Offset: 48h, 4Ch, 50h, 54h Access as a DWord			
Bit	Attr	Default	Description
31:13	RO	0	<i>Reserved</i>
12:10	RW	0	RANKOFFSET Rank Offset for calculating RANK. This corresponds to the first logical rank on the DIMM. The rank offset is always programmed to 0 for the DIMM 0 DOD registers. (DIMM 0 rank offset is always 0.) DIMM 1 DOD rank offset is 4 for two DIMMs per channel.
9	RW	0	DIMMPRESENT. DIMM slot is populated.
8:7	RW	0	NUMBANK This field defines the number of (real, not shadow) banks on these DIMMs. 00 = Four-banked 01 = Eight-banked 10 = Sixteen-banked
6:5	RW	0	NUMRANK. Number of Ranks This field defines the number of ranks on these DIMMs. 00 = Single Ranked 01 = Double Ranked 10 = <i>Reserved</i>
4:2	RW	0	NUMROW. Number of Rows This field defines the number of rows within these DIMMs. 000 = 2 ¹² Rows 001 = 2 ¹³ Rows 010 = 2 ¹⁴ Rows 011 = 2 ¹⁵ Rows 100 = 2 ¹⁶ Rows
1:0	RW	0	NUMCOL. Number of Columns This field defines the number of columns within on these DIMMs. 00 = 2 ¹⁰ columns 01 = 2 ¹¹ columns 10 = 2 ¹² columns 11 = RSVD



**4.11.3 MC_SAG_CHO_0; MC_SAG_CHO_1; MC_SAG_CHO_2;
MC_SAG_CHO_3; MC_SAG_CHO_4; MC_SAG_CHO_5;
MC_SAG_CHO_6; MC_SAG_CHO_7**

Channel Segment Address Registers. For each of the 8 interleave ranges, they specify the offset between the System Address and the Memory Address and the System Address bits used for level 1 interleave, which should not be translated to Memory Address bits. Memory Address is calculated from System Address and the contents of these registers by the following algorithm:

```
m[39:16] = SystemAddress[39:16] - (2's complement {Offset[23:0]});
m[15:6] = SystemAddress[15:6];
If (Removed[2]) {Bit 8 removed};
If (Removed[1]) {Bit 7 removed};
If (Removed[0]) {Bit 6 removed};
MemoryAddress[36:6] = m[36:6];
Removed Div3 Interleave
```

- 000 0 None
- 001 0 2-way
- 011 0 4-way
- 000 1 3-way
- 001 1 6-way

All other combinations are not supported.

Device: 4 Function: 1 Offset: 80h, 84h, 88h, 8Ch, 90h, 94h, 98h, 9Ch Access as a DWord			
Bit	Attr	Default	Description
31:28	RO	0	<i>Reserved</i>
27	RW	0	DIVBY3 This bit indicates the rule is a 3 or 6 way interleave.
26:24	RW	0	REMOVED These are the bits to be removed after offset subtraction. These bits correspond to System Address [8,7,6].
23:0	RW	0	OFFSET This value should be subtracted from the current system address to create a contiguous address space within a channel. BITS 9:0 ARE RESERVED AND MUST ALWAYS BE SET TO 0.

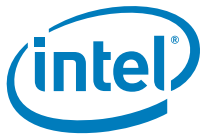

**4.11.4 MC_SAG_CH1_0; MC_SAG_CH1_1; MC_SAG_CH1_2;
MC_SAG_CH1_3; MC_SAG_CH1_4; MC_SAG_CH1_5;
MC_SAG_CH1_6; MC_SAG_CH1_7**

Channel Segment Address Registers. For each of the 8 interleave ranges, they specify the offset between the System Address and the Memory Address and the System Address bits used for level 1 interleave, which should not be translated to Memory Address bits. The first stage of Memory Address calculation using System Address and the contents of these registers is done by the following algorithm:

```
m[39:16] = SystemAddress[39:16] – (2's complement {Offset[23:0]});
m[15:6] = SystemAddress[15:6];
If (Removed[2]) {Bit 8 removed};
If (Removed[1]) {Bit 7 removed};
If (Removed[0]) {Bit 6 removed};
MemoryAddress[36:6] = m[36:6];
Removed Div3 Interleave
```

- 000 0 None
- 001 0 2-way
- 011 0 4-way
- 000 1 3-way
- 001 1 6-way

All other combinations are not supported.

Device: 5 Function: 1 Offset: 80h, 84h, 88h, 8Ch, 90h, 94h, 98h, 9Ch Access as a DWord			
Bit	Attr	Default	Description
31:28	RO	0	<i>Reserved</i>
27	RW	0	DIVBY3 This bit tells us that the rule is a 3- or 6-way interleave.
26:24	RW	0	REMOVED These are the bits to be removed after offset subtraction. These bits correspond to System Address [8,7,6].
23:0	RW	0	OFFSET This value should be subtracted from the current system address to create a contiguous address space within a channel. BITS 9:0 ARE RESERVED AND MUST ALWAYS BE SET TO 0.

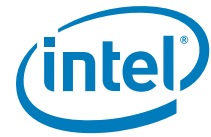

4.12 Integrated Memory Controller Channel Rank Registers

4.12.1 MC_RIR_LIMIT_CHO_0; MC_RIR_LIMIT_CHO_1; MC_RIR_LIMIT_CHO_2; MC_RIR_LIMIT_CHO_3; MC_RIR_LIMIT_CHO_4; MC_RIR_LIMIT_CHO_5; MC_RIR_LIMIT_CHO_6; MC_RIR_LIMIT_CHO_7

Channel 0 Rank Limit Range Registers.

Device: 4 Function: 2 Offset: 40h, 44h, 48h, 4Ch, 50h, 54h, 58h, 5Ch Access as a DWord			
Bit	Attr	Default	Description
31:10	RO	0	<i>Reserved</i>
9:0	RW	0	LIMIT This field specifies the top of the range being mapped to the ranks specified in the MC_RIR_WAY_CH registers. The most significant bits of the lowest address in this range is one greater than the limit field in the RIR register with the next lower index. This field is compared against MA[37:28].

4.12.2 MC_RIR_LIMIT_CH1_0; MC_RIR_LIMIT_CH1_1; MC_RIR_LIMIT_CH1_2; MC_RIR_LIMIT_CH1_3; MC_RIR_LIMIT_CH1_4; MC_RIR_LIMIT_CH1_5; MC_RIR_LIMIT_CH1_6; MC_RIR_LIMIT_CH1_7

Channel 1 Rank Limit Range Registers.

Device: 5 Function: 2 Offset: 40h, 44h, 48h, 4Ch, 50h, 54h, 58h, 5Ch Access as a DWord			
Bit	Attr	Default	Description
31:10	RO	0	<i>Reserved</i>
9:0	RW	0	LIMIT This field specifies the top of the range being mapped to the ranks specified in the MC_RIR_WAY_CH registers. The most significant bits of the lowest address in this range is one greater than the limit field in the RIR register with the next lower index. This field is compared against MA[37:28].

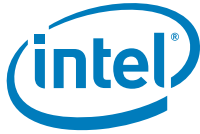

4.12.3 MC_RIR_WAY_CHO_0; MC_RIR_WAY_CHO_1;
 MC_RIR_WAY_CHO_2; MC_RIR_WAY_CHO_3;
 MC_RIR_WAY_CHO_4; MC_RIR_WAY_CHO_5
 MC_RIR_WAY_CHO_6; MC_RIR_WAY_CHO_7
 MC_RIR_WAY_CHO_8; MC_RIR_WAY_CHO_9
 MC_RIR_WAY_CHO_10; MC_RIR_WAY_CHO_11
 MC_RIR_WAY_CHO_12; MC_RIR_WAY_CHO_13
 MC_RIR_WAY_CHO_14; MC_RIR_WAY_CHO_15
 MC_RIR_WAY_CHO_16; MC_RIR_WAY_CHO_17
 MC_RIR_WAY_CHO_18; MC_RIR_WAY_CHO_19
 MC_RIR_WAY_CHO_20; MC_RIR_WAY_CHO_21
 MC_RIR_WAY_CHO_22; MC_RIR_WAY_CHO_23
 MC_RIR_WAY_CHO_24; MC_RIR_WAY_CHO_25
 MC_RIR_WAY_CHO_26; MC_RIR_WAY_CHO_27
 MC_RIR_WAY_CHO_28; MC_RIR_WAY_CHO_29
 MC_RIR_WAY_CHO_30; MC_RIR_WAY_CHO_31

Channel Rank Interleave Way Range Registers. These registers allow the user to define the ranks and offsets that apply to the ranges defined by the LIMIT in the MC_RIR_LIMIT_CH registers. The mappings are as follows:

RIR_LIMIT_CH{chan}[0] -> RIR_WAY_CH{chan}[3:0]
 RIR_LIMIT_CH{chan}[1] -> RIR_WAY_CH{chan}[7:6]
 RIR_LIMIT_CH{chan}[2] -> RIR_WAY_CH{chan}[11:10]
 RIR_LIMIT_CH{chan}[3] -> RIR_WAY_CH{chan}[15:14]
 RIR_LIMIT_CH{chan}[4] -> RIR_WAY_CH{chan}[19:18]
 RIR_LIMIT_CH{chan}[5] -> RIR_WAY_CH{chan}[23:22]
 RIR_LIMIT_CH{chan}[6] -> RIR_WAY_CH{chan}[27:26]
 RIR_LIMIT_CH{chan}[7] -> RIR_WAY_CH{chan}[31:28]

Device: 4 Function: 2 Offset: 80h, 84h, 88h, 8Ch, 90h, 94h, 98h, 9Ch, A0h, A4h, A8h, ACh, B0h, B4h, B8h, BCh, C0h, C4h, C8h, CCh, D0h, D4h, D8h, DCh, E0h, E4h, E8h, ECh, F0h, F4h, F8h, FCh Access as a DWord			
Bit	Attr	Default	Description
31:14	RO	0	Reserved
13:4	RW	0	OFFSET This field defines the offset used in the rank interleave. This is a 2's complement value.
3:0	RW	0	RANK This field defines which rank participates in WAY(n). If MC.CLOSEDPAGE=1, this field defines the DRAM rank selected when MemoryAddress[7:6]=(n). If MC.CLOSEDPAGE=0, this field defines which rank is selected when MemoryAddress[13:12]=(n). (n) is the instantiation of the register. This field is organized by physical rank. Bits [3:2] are the encoded DIMM ID (slot). Bits [1:0] are the rank within that DIMM.



4.12.4 MC_RIR_WAY_CH1_0; MC_RIR_WAY_CH1_1
 MC_RIR_WAY_CH1_2; MC_RIR_WAY_CH1_3
 MC_RIR_WAY_CH1_4; MC_RIR_WAY_CH1_5
 MC_RIR_WAY_CH1_6; MC_RIR_WAY_CH1_7
 MC_RIR_WAY_CH1_8; MC_RIR_WAY_CH1_9
 MC_RIR_WAY_CH1_10; MC_RIR_WAY_CH1_11
 MC_RIR_WAY_CH1_12; MC_RIR_WAY_CH1_13
 MC_RIR_WAY_CH1_14; MC_RIR_WAY_CH1_15
 MC_RIR_WAY_CH1_16; MC_RIR_WAY_CH1_17
 MC_RIR_WAY_CH1_18; MC_RIR_WAY_CH1_19
 MC_RIR_WAY_CH1_20; MC_RIR_WAY_CH1_21
 MC_RIR_WAY_CH1_22; MC_RIR_WAY_CH1_23
 MC_RIR_WAY_CH1_24; MC_RIR_WAY_CH1_25
 MC_RIR_WAY_CH1_26; MC_RIR_WAY_CH1_27
 MC_RIR_WAY_CH1_28; MC_RIR_WAY_CH1_29
 MC_RIR_WAY_CH1_30; MC_RIR_WAY_CH1_31

Channel Rank Interleave Way Range Registers. These registers allow the user to define the ranks and offsets that apply to the ranges defined by the LIMIT in the MC_RIR_LIMIT_CH registers. The mappings are as follows:

- RIR_LIMIT_CH{chan}[0] -> RIR_WAY_CH{chan}[3:0]
- RIR_LIMIT_CH{chan}[1] -> RIR_WAY_CH{chan}[7:6]
- RIR_LIMIT_CH{chan}[2] -> RIR_WAY_CH{chan}[11:10]
- RIR_LIMIT_CH{chan}[3] -> RIR_WAY_CH{chan}[15:14]
- RIR_LIMIT_CH{chan}[4] -> RIR_WAY_CH{chan}[19:18]
- RIR_LIMIT_CH{chan}[5] -> RIR_WAY_CH{chan}[23:22]
- RIR_LIMIT_CH{chan}[6] -> RIR_WAY_CH{chan}[27:26]
- RIR_LIMIT_CH{chan}[7] -> RIR_WAY_CH{chan}[31:28]

Device: 5 Function: 2 Offset: 80h, 84h, 88h, 8Ch, 90h, 94h, 98h, 9Ch, A0h, A4h, A8h, ACh, B0h, B4h, B8h, BCh, C0h, C4h, C8h, CCh, D0h, D4h, D8h, DCh, E0h, E4h, E8h, Ech, F0h, F4h, F8h, FCh Access as a DWord			
Bit	Attr	Default	Description
31:5	RO	0	<i>Reserved</i>
13:4	RW	0	OFFSET This field defines the offset used in the rank interleave. This is a 2's complement value.
3:0	RW	0	RANK This field defines which rank participates in WAY(n). If MC.CLOSEDPAGE=1, this field defines the DRAM rank selected when MemoryAddress[7:6]=(n). If MC.CLOSEDPAGE=0, this field defines which rank is selected when MemoryAddress[13:12]=(n). (n) is the instantiation of the register. This field is organized by physical rank. Bits [3:2] are the encoded DIMM ID (slot). Bits [1:0] are the rank within that DIMM.



4.13 Memory Thermal Control

4.13.1 MC_THERMAL_CONTROLO MC_THERMAL_CONTROL1

Controls for the Integrated Memory Controller thermal throttle logic.

Device: 4, 5 Function: 3 Offset: 48h Access as a DWord			
Bit	Attr	Default	Description
31:3	RO	0	<i>Reserved</i>
2	RW	1	APPLY_SAFE Enable the application of safe values while MC_THERMAL_PARAMS_B.SAFE_INTERVAL is exceeded.
1:0	RW	0	THROTTLE_MODE Selects throttling mode. 0 = Throttle disabled 1 = Open Loop: Throttle when Virtual Temperature is greater than MC_THROTTLE_OFFSET. 2 = Closed Loop: Throttle when MC_CLOSED_LOOP.THROTTLE_NOW is set. 3 = Closed Loop: Throttle when MC_DDR_THERM_COMMAND.THROTTLE is set and the PM_EXT_TS# pin is asserted OR OLTT will be implemented (Condition 1).

4.13.2 MC_THERMAL_STATUSO MC_THERMAL_STATUS1

Status registers for the thermal throttling logic.

Device: 4, 5 Function: 3 Offset: 4Ch Access as a DWord			
Bit	Attr	Default	Description
31:30	RO	0	<i>Reserved</i>
29:4	RO	0	CYCLES_THROTTLED This field indicates the number of throttle cycles triggered in all ranks since last temperature sample.
3:0	RO	0	RANK_TEMP The field specifies whether the rank is above throttling threshold.

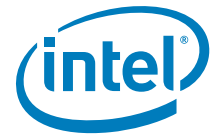

4.13.3 MC_THERMAL_DEFEATURE0 MC_THERMAL_DEFEATURE1

Thermal Throttle defeature register.

Device: 4, 5 Function: 3 Offset: 50h Access as a DWord			
Bit	Attr	Default	Description
31:1	RO	0	<i>Reserved</i>
0	RW1S	0	THERM_REG_LOCK When set to 1, no further modification of all thermal throttle registers are allowed. This bit must be set to the same value for all channels.

4.13.4 MC_THERMAL_PARAMS_A0 MC_THERMAL_PARAMS_A1

Parameters used by Open Loop Throughput Throttling (OLTT) and Closed Loop Thermal Throttling (CLTT).

Device: 4, 5 Function: 3 Offset: 60h Access as a DWord			
Bit	Attr	Default	Description
31:24	RW	0	CKE_ASSERT_ENERGY Energy of having CKE asserted when no command is issued.
23:16	RW	0	CKE_DEASSERT_ENERGY Energy of having CKE deasserted when no command is issued.
15:8	RW	0	WRCMD_ENERGY Energy of a write including data transfer.
7:0	RW	0	RDCMD_ENERGY Energy of a read including data transfer.



4.13.5 MC_THERMAL_PARAMS_B0 MC_THERMAL_PARAMS_B1

Parameters used by the thermal throttling logic.

Device: 4, 5 Function: 3 Offset: 64h Access as a DWord			
Bit	Attr	Default	Description
31:26	RW	1	SAFE_INTERVAL Safe values for cooling coefficient and duty cycle will be applied while the SAFE_INTERVAL is exceeded. This interval is the number of ZQ intervals since the last time the MC_COOLING_COEF or MC_CLOSED_LOOP registers have been written. A register to write to MC_COOLING_COEF or MC_CLOSED_LOOP will re-apply the normal MC_COOLING_COEF and MC_CLOSED_LOOP.MIN_THROTTLE_DUTY_CYC values. The register value written need not be different; writing the current value will suffice. The MC_THERMAL_STATUS.CYCLES_THROTTLED field is reloaded when the number of ZQ intervals exceeds this value. This field must not be programmed to 0; this value is invalid.
25:16	RW	255	SAFE_DUTY_CYC This value replaces MC_CLOSED_LOOP.MIN_THROTTLE_DUTY_CYC while the MC_THERMAL_PARAMS_B.SAFE_INTERVAL is exceeded.
15:8	RW	1	SAFE_COOL_COEF This value replaces MC_COOLING_COEF while the THERMAL_PARAMS_B.SAFE_INTERVAL is exceeded.
7:0	RW	0	ACTCMD_ENERGY Energy of an Activate/Precharge Cycle.

4.13.6 MC_COOLING_COEF0 MC_COOLING_COEF1

Heat removed from DRAM 8 DCLKs. This should be scaled relative to the per command weights and the initial value of the throttling threshold. This includes idle command and refresh energies. If 2X refresh is supported, the worst case of 2X refresh must be assumed.

When there are more than 4 ranks attached to the channel, the thermal throttle logic is shared.

Device: 4, 5 Function: 3 Offset: 80h Access as a DWord			
Bit	Attr	Default	Description
31:24	RW	255	RANK3. Rank 3 Cooling Coefficient.
23:16	RW	255	RANK2. Rank 2 Cooling Coefficient.
15:8	RW	255	RANK1. Rank 1 Cooling Coefficient.
7:0	RW	255	RANK0. Rank 0 Cooling Coefficient.

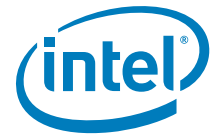

4.13.7 MC_CLOSED_LOOP0 MC_CLOSED_LOOP1

This register controls the closed loop thermal response of the DRAM thermal throttle logic. It supports immediate thermal throttle and 2X refresh. In addition, the register is used to configure the throttling duty cycle.

Device: 4, 5 Function: 3 Offset: 84h Access as a DWord			
Bit	Attr	Default	Description
31:18	RO	0	<i>Reserved</i>
17:8	RW	64	MIN_THROTTLE_DUTY_CYC This parameter represents the minimum number of DCLKs of operation allowed after throttling. In order to provide actual command opportunities, the number of clocks between CKE deassertion and first command should be considered.
7:5	RO	0	<i>Reserved</i>
4	RW	0	REF_2X_NOW Direct control of dynamic 2X refresh if direct throttling is enabled.
3:0	RW	0	THROTTLE_NOW Throttler Vector to directly control throttling if MC_THERMAL_CONTROL.THROTTLE_MODE == 2.

4.13.8 MC_THROTTLE_OFFSET0 MC_THROTTLE_OFFSET1

Compared against bits [36:29] of virtual temperature of each rank stored in RANK_VIRTUAL_TEMP to determine the throttle point. Recommended value for each rank is 255.

When there are more than 4 ranks attached to the channel, the thermal throttle logic is shared.

Device: 4, 5 Function: 3 Offset: 88h Access as a DWord			
Bit	Attr	Default	Description
31:24	RW	0	RANK3. Rank 3 throttle offset.
23:16	RW	0	RANK2. Rank 2 throttle offset.
15:8	RW	0	RANK1. Rank 1 throttle offset.
7:0	RW	0	RANK0. Rank 0 throttle offset.



4.13.9 MC_RANK_VIRTUAL_TEMPO MC_RANK_VIRTUAL_TEMP1

This register contains the 8 most significant bits [37:30] of the virtual temperature of each rank. The difference between the virtual temperature and the sensor temperature can be used to determine how fast fan speed should be increased. The value stored is right shifted one bit to the right with respect to the corresponding MC_Throttle_Offset register value. For example when a rank throttle offset is set to 40h, the value read from the corresponding in MC_RANK_VIRTUAL_TEMP register is 20h.

When there are more than 4 ranks attached to the channel, the thermal throttle logic is shared.

Device: 4, 5 Function: 3 Offset: 98h Access as a DWord			
Bit	Attr	Default	Description
31:24	RO	0	RANK3. Rank 3 virtual temperature.
23:16	RO	0	RANK2. Rank 2 virtual temperature.
15:8	RO	0	RANK1. Rank 1 virtual temperature.
7:0	RO	0	RANK0. Rank 0 virtual temperature.

4.13.10 MC_DDR_THERM_COMMAND0 MC_DDR_THERM_COMMAND1

This register contains the command portion of the functionality of the PM_EXT_TS#[1:0] signals.

Device: 4, 5 Function: 3 Offset: 9Ch Access as a DWord			
Bit	Attr	Default	Description
31:4	RO	0	<i>Reserved</i>
3	RW	0	THROTTLE Force throttling when DDR_THERM# pin is asserted.
2	RW	0	REF_2X Force 2x refresh as long as DDR_THERM# is asserted.
1	RW	0	DISABLE_EXTTTS DDR_THERM# pin disable, forces signal to look deasserted; thus, a 1.
0	RW	0	LOCK When set, all bits in this register are RO and cannot be written.

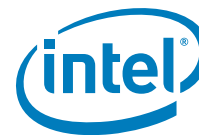

4.13.11 MC_DDR_THERM_STATUS0 MC_DDR_THERM_STATUS1

This register contains the status portion of the DDR_THERM# functionality as described in the processor datasheet (that is, what is happening or has happened with respect to the pin).

Device: 4, 5 Function: 3 Offset: A4h Access as a DWord			
Bit	Attr	Default	Description
31:3	RO	0	<i>Reserved</i>
2	RO	0	ASSERTION An assertion edge was seen on DDR_THERM#. Write-1-to-clear.
1	RO	0	DEASSERTION A deassertion edge was seen on DDR_THERM#. Write-1-to-clear.
0	RO	0	STATE Present logical state of DDR_THERM# bit. This is a static indication of the pin, and may be several clocks out of date due to the delay between the pin and the signal. STATE = 0 means DDR_THERM# is deasserted STATE = 1 means DDR_THERM# is asserted

§





5 System Address Map

5.1 Introduction

This chapter provides a basic overview of the system address map and describes how the processor IIO comprehends and decodes the various regions in the system address map. The term “IIO” in this chapter refers to processor IIO (in both End Point and Dual IIO Proxy modes). This chapter does not provide the full details of the platform system address space as viewed by software and also it does not provide the details of processor address decoding.

The IIO supports 64 GB (36 bit) of host address space and 64 KB+3 of addressable I/O space. There is a programmable memory address space under the 1-MB region which is divided into regions which can be individually controlled with programmable attributes such as Disable, Read/Write, Write Only, or Read Only. Attribute programming is described in [Section 3.5.2](#). This section focuses on how the memory space is partitioned and what the separate memory regions are used for. I/O address space has simpler mapping, and is explained near the end of this section.

The processor IIO supports 36 bits (35:0) of memory addressing on its Intel QuickPath Interconnect interface. IIO also supports receiving and decoding 64 bits of address from PCI Express. Memory transactions received from PCI Express that go above the top of physical address space supported on Intel QuickPath Interconnect (which is dependent on the Intel QuickPath Interconnect profile but is always less than or equal to 2^{40} for IIO) are reported as errors by IIO. The IIO as a requester would never generate requests on PCI Express with any of Address Bits 63 to 40 set. For packets that IIO receives from Intel QuickPath Interconnect and for packets that IIO receives from PCIe, the IIO always performs a full 64-bit target address decoding. This means that for the processor, Bits 36 to 63 of the address must be set to all zeros in order for the IIO's target address decoder to positively decode and acknowledge the packet.

The IIO supports 16 bits of I/O addressing on its Intel QuickPath Interconnect interface. IIO also supports receiving and decoding the full 32 bits of I/O address from PCI Express. I/O transactions initiated by the processor on Intel QuickPath Interconnect can have non-zero value for address bits 16 and above. This is an artifact of the uncore logic in the processor. IIO's outbound I/O address decoder must ignore them when decoding the I/O address space. I/O requests received from PCI Express that are beyond 64 KB are reported as errors by IIO. IIO as a requester would never generate I/O requests on PCI Express with any of address bits 31 to 16 set.

The IIO supports PCI configuration addressing up to 256 buses, 32 devices per bus and 8 functions per device. A single grouping of 256 buses, 32 devices per bus and 8 functions per device is referred to as a PCI *segment*. All configuration addressing within an IIO and hierarchies below an IIO must be within one segment. IIO does not support being in multiple PCI segments.

Refer to [Section 5.8.3](#) for address map details when Intel VT-d is enabled.

Note: In debug mode, some address bits in the Intel QuickPath Interconnect header are used for passing source information and hence are not decoded for forwarding transactions.

For the processor, the IIO is always the legacy IIO and DMI is always the subtractive decode port.

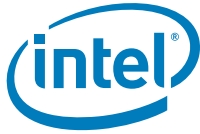

The processor supports PCI Express* upper pre-fetchable base/limit registers. This allows the PCI Express unit to claim IO accesses above 36 bits, complying with the PCI Express Spec. Addressing of greater than 8 GB is allowed on either the DMI Interface or PCI Express interface. The memory controller supports a maximum of 8 GB of DRAM. No DRAM memory will be accessible above 8 GB.

When running in internal graphics mode, writes to GMADR range linear range are supported. Write accesses to linear regions are supported from DMI only. Write accesses to tileX and tileY regions (defined using fence registers) are not supported from DMI or the PEG port. GMADR read accesses are not supported from either DMI or PEG.

In the following sections, it is assumed that all of the compatibility memory ranges reside on the DMI Interface. The exception to this rule is VGA ranges, which may be mapped to PCI Express, DMI, or to the internal graphics device (IGD). In the absence of more specific references, cycle descriptions referencing PCI should be interpreted as the DMI Interface/PCI, while cycle descriptions referencing PCI Express or IGD are related to the PCI Express bus or the internal graphics device respectively. The Processor does not remap APIC or any other memory spaces above TOLM. The TOLM register is set to the appropriate value by BIOS. The reclaim base/reclaim limit registers remap logical accesses bound for addresses above 4 GB onto physical addresses that fall within DRAM.

5.2 Memory Address Space

Figure 5-1 shows the IIO system memory address space. There are three basic regions of memory address space in the system: address below 1 MB, address between 1 MB and 4 GB, and address above 4 GB. These regions are described in the following sections.

Throughout this section, there will be references to subtractive decode port. It refers to the port of IIO that is attached to a legacy PCH (DMI). This port is also the recipient of all addresses that are not positively decoded towards any PCIE device or towards memory. Refer to [Section 5.8.1](#) and [Section 5.8.2](#).

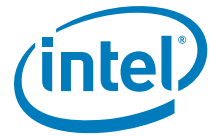

5.2.1 System Address Map

Figure 5-1. System address Map

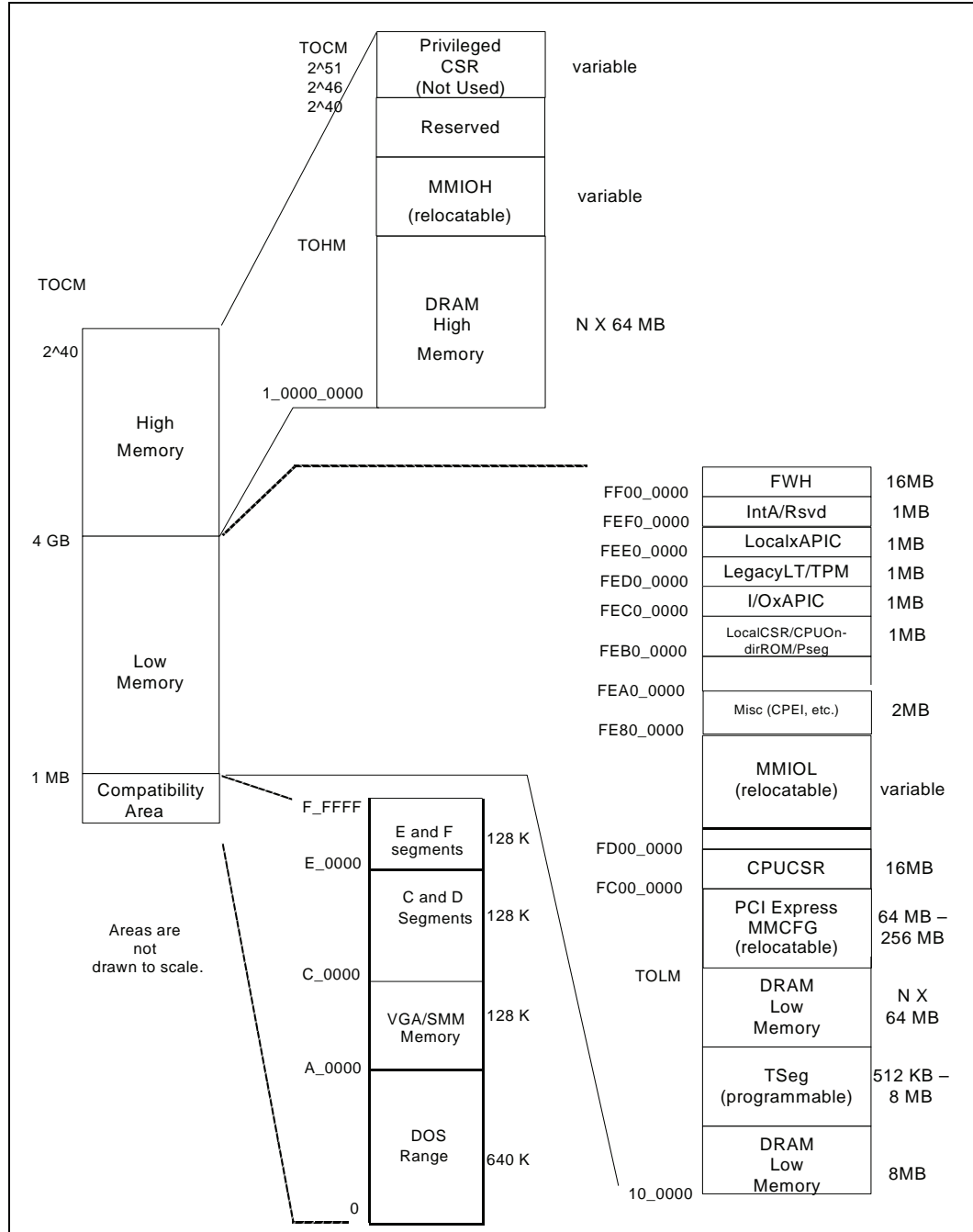



5.2.2 System DRAM Memory Regions

Address Region	From	To
640-KB MS-DOS* Memory	000_0000_0000h	000_0009_FFFFh
1 MB to Top-of-Low-Memory	000_0010_0000h	TOLM
Bottom-of-High-Memory to Top-of-High-Memory	4 GB	TOHM

These address ranges are always mapped to system DRAM memory, regardless of the system configuration. The top of main memory below 4 GB is defined by the Top of Low Memory (TOLM). Memory between 4 GB and TOHM is extended system memory. Since the platform may contain multiple processors, the memory space is divided amongst the processors. There may be memory holes between each processor's memory regions. These system memory regions are either coherent or non-coherent. A set of range registers in the IIO define a non-coherent memory region (NcMem.Base/NcMem.Limit) within the system DRAM memory region shown above. System DRAM memory region outside of this range but within the DRAM region shown in table above is considered coherent.

For inbound transactions, IIO positively decodes these ranges using a couple of software programmable range registers. Refer to [Table 5-8](#) for details of inbound decoding towards system memory. For outbound transactions, it would be an error for IIO to receive non-coherent accesses to these addresses from Intel QuickPath Interconnect, but IIO does not explicitly check for this error condition but would rather forward such accesses to the subtractive decode port, if one exists downstream, by virtue of subtractive decoding, else it is master aborted. Refer to [Section 5.8.1](#) for further details.

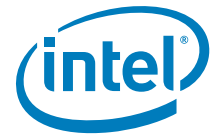

5.2.3 VGA/SMM and Legacy C/D/E/F Regions

Figure 5-2 shows the memory address regions below 1 MB. These regions are legacy access ranges.

Figure 5-2. VGA/SMM and Legacy C/D/E/F Regions

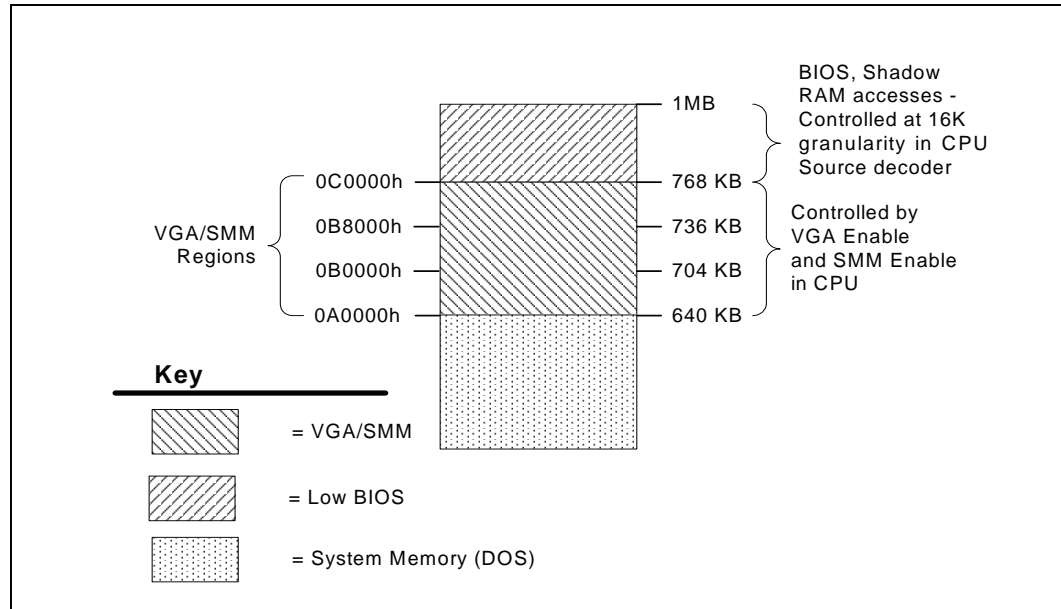

5.2.3.1 VGA/SMM Memory Space

Address Region	From	To
VGA	000_000A_0000h	000_000B_FFFFh

This legacy address range is used by video cards to map a frame buffer or a character-based video buffer. By default, accesses to this region are forwarded to main memory by the processor. However, once firmware figures out where the VGA device is in the system, it sets up the processor's source address decoders to forward these accesses to the IIO. Within IIO, if the VGAEN bit is set in the PCI bridge control register (BCTRL) of a PCIe port, then transactions within the VGA space (defined above) are forwarded to the associated port, regardless of the settings of the peer-to-peer memory address ranges of that port. If none of the PCIe ports have the VGAEN bit set (note that per the IIO address map constraints the VGA memory addresses cannot be included as part of the normal peer-to-peer bridge memory apertures in the root ports), then these accesses are forwarded to the subtractive decode port. Also refer to the *PCI-PCI Bridge 1.2 Specification* for further details on the VGA decoding. Note that only one VGA device may be enabled per system partition. The VGAEN bit in the PCIe bridge control register must be set only in one PCIe port in a system partition. IIO does not support the MDA (monochrome display adapter) space independent of the VGA space.

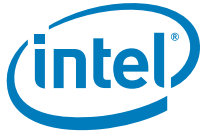

The VGA memory address range can also be mapped to system memory in SMM. IIO is totally transparent to the workings of this region in the SMM mode. All outbound and inbound accesses to this address range are always forwarded to the VGA device by the IIO. Refer to [Table 5-7](#) and [Table 5-8](#) for further details of inbound and outbound VGA decoding.

5.2.3.2 C/D/E/F Segments

The E/F region is used for BIOS flash in the early stages of the boot flow and could be mapped to any firmware hub port in IA32 system. E/F could also be used to address DRAM from an I/O device (processors have registers to select between addressing BIOS flash and DRAM). IIO does not explicitly decode the E/F region in the outbound direction and relies on subtractive decoding to forward accesses to this region to the legacy PCH through DMI. IIO does not explicitly decode inbound accesses to the E/F address region. It is expected that the DRAM low range that IIO decodes will be setup to cover the E/F address range. By virtue of that, IIO will forward inbound accesses to the E/F segment to system DRAM. If it is necessary to block inbound access to these ranges, a Generic Memory Protection Ranges could be used.

C/D region is used in system DRAM memory for BIOS and option ROM shadowing. IIO does not explicitly decode these regions for inbound accesses. Software must program one of the system DRAM memory decode ranges that IIO uses (for inbound system memory decoding) to include these ranges. If it is necessary to block inbound access to these ranges, the Generic Memory Protection Ranges could be used.

All outbound accesses to the C-F regions are first positively decoded against all valid targets' address ranges and if none match, these address are forwarded to the subtractive decode port of the IIO.

IIO will complete locks to this range, but cannot guarantee atomicity when writes and reads are mapped to separate destinations.

5.2.4 Address Region between 1 MB and TOLM

Note: The ME stolen memory space must be located below Top Of Low Memory (TOLM) (or TOHM if it needs to be above 4 GB).

This region is always allocated to system DRAM memory. Software must set up one of the coarse memory decode ranges that IIO uses (for inbound system memory decoding) to include this address range. By virtue of that, IIO will forward inbound accesses to this region to system memory (unless any of these access addresses fall within a protected DRAM range as described in [Section 5.2.7](#)). It would be an error for IIO to receive outbound accesses to an address in this region, other than snoop requests, from Intel QuickPath Interconnect, but IIO does not explicitly check for this error condition but would rather forward such accesses to the subtractive decode port by virtue of subtractive decoding.

Any inbound access that decodes to be within one of the two coarse memory decode windows but has no real DRAM populated for that address, will result in a master abort response on PCI Express.

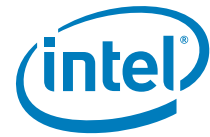

5.2.4.1 Relocatable TSEG

Address Region	From	To
TSEG	FE00_0000h (default)	FE7F_FFFFh (default)

These are system DRAM memory regions that are used for SMM/CMM mode operation. IIO would complete abort all inbound transactions that target these address ranges. IIO should not receive transactions that target these addresses in the outbound direction, but IIO does not explicitly check for this error condition but rather subtractively forwards such transactions to the subtractive decode port of the IIO, if one exists downstream else it is master aborted.

The location (1-MB aligned) and size (from 512 KB to 8 MB) in IIO can be programmed by software.

Figure 5-3. Pre-allocated Memory Example for 64 MB DRAM, 1 MB VGA, 1 MB GTT Stolen and 1 MB TSEG

Memory Segments	Attributes	Comments
0000_0000h – 03CF_FFFFh	R/W	Available System Memory 61 MB
03D0_0000h – 03DF_FFFFh	SMM Mode Only - processor Reads	TSEG Address Range & Pre-allocated Memory
03E0_0000h – 03EF_FFFFh	R/W	Pre-allocated Graphics VGA memory. 1 MB (or 4/8/16/32/64/128/256 MB) when IGD is enabled.
03F0_0000h – 03FF_FFFFh	R/W	Pre-allocated Graphics GTT stolen memory. 1 MB (or 2 MB) when IGD is enabled.

5.2.5 Address Region from TOLM to 4 GB

5.2.5.1 PCI Express® Memory Mapped Configuration Space

This is the system address region that is allocated for software to access the PCI Express Configuration Space. This region is relocatable below 4 GB by BIOS/firmware and IIO has no explicit knowledge of this address range. It is the responsibility of software to make sure that this system address range is not included in any of the system DRAM memory ranges that IIO decodes inbound. If software were to mis-program IIO in this way, accesses to this space could potentially be sent to the processor by the IIO.

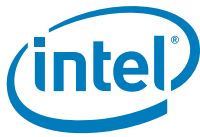

5.2.5.2 MMIOL

Address Region	From	To
MMIOL	GMMIOL.Base	GMMIOL.Limit

This region is used for PCIe device memory addressing below 4 GB. Each IIO in the system is allocated a portion of this address range and individual PCIe ports and other integrated devices within an IIO (for example, VTBAR) use sub-portions within that range. There are IIO-specific requirements on how software allocates this system region amongst IIOs to support of peer-to-peer between IIOs. Refer to [Section 5.8.3](#) for details of these restrictions. Each IIO has a couple of MMIOL address range registers (LMMIOL and GMMIOL) to support local peer-to-peer in the MMIOL address range. Refer to [Section 5.8](#) for details of how these registers are used in the inbound and outbound MMIOL range decoding.

5.2.5.3 Miscellaneous

This region is used by the processor for miscellaneous functionality including an address range that software can write to generate CPEI message on Intel QuickPath Interconnect, and so forth. IIO aborts all inbound accesses to this region. Outbound accesses to this region is not explicitly decoded by IIO and are forwarded to downstream subtractive decode port, if one exists, by virtue of subtractive decoding else it is master aborted.

Address Region	From	To
Misc	FE80_0000h	FE9F_FFFFh

5.2.5.4 Processor Local CSR, On-die ROM, and Processor PSeg

Address Region	From	To
processor Local CSR and PSeg	FE80_0000h	FEBF_FFFFh

This region accommodates processor's local CSRs, on-die ROM, and PSeg. IIO will block all inbound accesses from PCIe to this address region and return a completer abort response. Outbound accesses to this address range are not part of the normal programming model and IIO subtractively sends such accesses to the subtractive decode port of the IIO, if one exists downstream (else Master Abort).

5.2.5.5 Legacy/HPET/TXT/TPM/Others

Address Region	From	To
Legacy/HPET/TXT/TPM/Others	FED0_0000h	FEDF_FFFFh

This region covers the High performance event timers, TXT registers, TPM region, and so forth, in the PCH. All inbound/peer-to-peer accesses to this region are completer aborted by IIO.



5.2.5.6 Local XAPIC

Address Region	From	To
Local XAPIC	FEE0_0000h	FEFF_FFFFh

The processor Interrupt space is the address used to deliver interrupts to the processor(s). Message Signaled Interrupts (MSI) from PCIe devices that target this address are forwarded as SpcInt messages to the processor.

The processors may also use this region to send inter-processor interrupts (IPI) from one processor to another. But, IIO is never a recipient of such an interrupt. Inbound reads to this address are considered errors and are completer aborted by IIO. Outbound accesses to this address are considered as errors, but IIO does not explicitly check for this error condition but simply forwards the transaction subtractively to its subtractive decode port, if one exists downstream.

5.2.5.7 High BIOS Area

The top 2 MB (FEE0_0000h–FFFF_FFFFh) of the PCI Memory Address Range is reserved for System BIOS (High BIOS), extended BIOS for PCI devices, and the A20 alias of the system BIOS. The processor begins execution from the High BIOS after reset. This region is mapped to DMI Interface so that the upper subset of this region aliases to 16-MB to 256-KB range. The actual address space required for the BIOS is less than 2 MB, but the minimum processor MTRR range for this region is 2 MB — so that full 2 MB must be considered.

5.2.5.8 INTA/Rsvd

Address Region	From	To
IntA/Others	FEF0_0000h	FEFF_FFFFh

This region accommodates IPF architecture-specific address regions. All inbound accesses to this address region are completer aborted by the IIO. All outbound accesses to this address region are subtractively sent to the subtractive decode port of the IIO, if one exists downstream.

5.2.5.9 Firmware

Address Region	From	To
HIGHBIO	FF00_0000h	FFFF_FFFFh

This ranges starts at FF00_0000h and ends at FFFF_FFFFh. It is used for BIOS/Firmware. Outbound accesses within this range are forwarded to firmware hubs. Refer to [Section 5.8.1.2](#) for firmware decoding details in IIO. During boot initialization, IIO with firmware connected south of it will communicate this on all Intel QuickPath Interconnect ports so that processor hardware can configure the path to firmware. IIO does not support accesses to this address range inbound, that is, those inbound transactions are aborted and a completer abort response is sent back.



5.2.6 Address Regions above 4 GB

5.2.6.1 High System Memory

Address Region	From	To
High System Memory	4 GB	TOHM

This region is used to describe the address range of system memory above the 4-GB boundary. IIO forwards all inbound accesses to this region to the system memory port (unless any of these access addresses are also marked protected.). A portion of the address range within this high system DRAM region could be marked non-coherent (using NcMem.Base/NcMem.Limit register) and IIO treats them as non-coherent. All other addresses are treated as coherent (unless modified using the NS attributes on PCI Express). IIO should not receive outbound accesses to this region, but IIO does not explicitly check for this error condition but rather subtractively forwards these accesses to the subtractive decode port, if one exists downstream (else it is a programming error).

Software must setup this address range such that any recovered DRAM hole from below the 4-GB boundary and that might encompass a protected sub-region is not included in the range.

5.2.6.2 Memory Mapped IO High

The high memory mapped I/O range is located above main memory. This region is used to map I/O address requirements above 4-GB range. Each IIO in the system is allocated a portion of this system address region and within that portion each PCIe port use up a sub-range. Refer to [Section 5.8.3](#) for details of these restrictions.

Each IIO has a couple of MMIOH address range registers (LMMIOH and GMMIOH) to support local and remote peer-to-peer in the MMIOH address range. Refer to [Section 5.8.1](#) and [Section 5.8.2](#) for details of inbound and outbound decoding for accesses to this region.

For the processor, LMMIOH range registers define the IIO high memory mapped range. GMMIOH.BAS/LIM must be set to the same value as LMMIOH.BASE/LIM.



5.2.6.3 BIOS Notes on Address Allocation above 4 GB

The processor does not support hot added memory. Hence, no special BIOS actions are required for address allocation above 4 GB to maintain a hole.

Since IIO supports only a single contiguous address range for accesses to system DRAM above 4 GB, BIOS must make sure that there is enough reserved space gap left between the top of high memory and the bottom of the MMIOH region, if the system cares about memory hot add. This gap can be used to address hot added memory in the system and would fit the constraints imposed by IIO decode mechanism.

5.2.7 Protected System DRAM Regions

IIO supports three address ranges for protecting various system DRAM regions that carry protected OS code or other proprietary platform information. The ranges are:

- Intel VT-d protected high range
- Intel VT-d protected low range

5.3 IO Address Space

There are four classes of I/O addresses that are specifically decoded by the platform:

1. I/O addresses used for VGA controllers.
2. I/O addresses used for ISA aliasing
3. I/O addresses used for the PCI Configuration protocol - CFC/CF8
4. I/O addresses used by downstream PCI/PCIe IO devices, typically legacy devices. The range can be further divided by various downstream ports in the IIO. Each downstream port in IIO contains a BAR to decode its I/O range. Address that falls within this range is forwarded to its respective IIO, then subsequently to the downstream port.

5.3.1 VGA I/O Addresses

Legacy VGA device uses up the addresses 3B0h–3BBh, 3C0h–3DFh. Any PCIe, DMI port in IIO can be a valid target of these address ranges if the VGAEN bit in the peer-to-peer bridge control register corresponding to that port is set (besides the condition where these regions are positively decoded within the peer-to-peer I/O address range). In the outbound direction at the PCI-to-PCI bridge (part of PCIe port) direction, by default, IIO only decodes the bottom 10 bits of the 16 bit I/O address when decoding this VGA address range with the VGAEN bit set in the peer-to-peer bridge control register. But when the VGA16DECEN bit is set in addition to VGAEN being set, IIO performs a full 16 bit decode for that port when decoding the VGA address range outbound. In general, on outbound accesses to this space, IIO positively decodes the address ranges of all PCIe ports per the peer-to-peer bridge decoding rules (refer to the *PCI-PCI Bridge 1.2 Specification* for details). When no target is positively identified, IIO sends it down its subtractive decode port (if one exists, else, Master Abort).



5.3.2 ISA Addresses

IIO supports ISA addressing per the *PCI-PCI Bridge 1.2 Specification*. ISA addressing is enabled in a PCIe port using the ISAEN bit in the bridge configuration space. Note that when VGAEN bit is set in a PCIe port without the VGA16DECEN bit being set, the ISAEN bit must be set in all the peer PCIe ports in the system.

5.3.3 CFC/CF8 Addresses

These addresses are used by legacy operating systems to generate PCI configuration cycles. These have been replaced with a memory-mapped configuration access mechanism in PCI Express (which only PCI Express aware operating systems utilize). That said, IIO does not explicitly decode these I/O addresses and take any specific action. These accesses are decoded as part of the normal inbound and outbound I/O transaction flow and follow the same routing rules. Refer also to [Table 5-8](#) and [Table 5-10](#) for further details of I/O address decoding in IIO.

5.3.4 PCIe Device I/O Addresses

These addresses could be anywhere in the 64KB I/O space and are used to allocate I/O addresses to PCIe devices. Each IIO is allocated a chunk of I/O address space and there are IIO-specific requirements on how these chunks are distributed amongst IIOs to support peer-to-peer. Refer to [Section 5.8.3](#) for details of these restrictions. Each IIO has a couple of IO address range registers (LIO and GIO) to support local and remote peer-to-peer in the IO address range (debug mode only). Refer to [Section 5.8.1](#) and [Section 5.8.2](#) for details of how these registers are used in the inbound and outbound IO address decoding.

5.4 Configuration/CSR Space

There are two types of configuration/CSR space in IIO - PCIe configuration space and Intel QuickPath Interconnect CPUCSR space. PCIe configuration space is the standard PCIe configuration space defined in the PCIe specification. CSR space is memory mapped space used exclusively for special processor registers.

5.4.1 PCIe Configuration Space

PCIe configuration space allows for upto 256 buses, 32 devices per bus and 8 functions per device. There could be multiple groups of these configuration spaces and each is called a *segment*. IIO can support multiple segments in a system. But each IIO can span one segment and no peer-to-peer accesses are allowed between segments. Within each IIO there are multiple devices that are in the PCIe configuration space. All these devices are accessed using NcCfgWr/Rd transactions on Intel QuickPath Interconnect. Within each segment, bus 0 is always assigned to the internal bus number of IIO which has the legacy PCH attached to it. Refer to [Section 5.8.1](#) and [Section 5.8.2](#) for details of IIO configuration transaction decoding.

Each IIO is allocated a chunk of PCIe bus numbers and there are IIO-specific requirements on how these chunks are distributed amongst IIOs to support peer-to-peer. Refer to [Section 5.8.3](#) for details of these restrictions. Each IIO has a couple of configuration bus range registers (LCFGBUS and GCFGBUS) to support local and

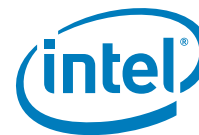

remote peer-to-peer. Refer to section [Section 5.8.1](#) and [Section 5.8.2](#) for details of how these registers are used in the inbound and outbound memory/configuration/message decoding.

Configuration transactions initiated by the processor on Intel QuickPath Interconnect can have non-zero value for address bits 28 and above. This is an artifact of the uncore logic in the processor. IIO's outbound configuration address decoder must ignore these bits when decoding the PCIe configuration space.

5.5 System Management Mode (SMM)

System Management Mode uses main memory for System Management RAM (SMM RAM). The Processor supports: Compatible SMRAM (C_SMRAM), High Segment (HSEG), and Top of Memory Segment (TSEG). System Management RAM space provides a memory area that is available for the Intel SMI handlers and code and data storage. This memory resource is normally hidden from the system OS so that the processor has immediate access to this memory space upon entry to SMM. Processor provides three SMRAM options:

- Below 1 MB option that supports compatible Intel SMI handlers.
- Above 1 MB option that allows new Intel SMI handlers to execute with write-back cacheable SMRAM.
- Optional TSEG area of 1 MB, 2 MB, or 8 MB in size. The TSEG area lies below IGD stolen memory.

The above 1 MB solutions require changes to compatible SMRAM handlers code to properly execute above 1 MB.

Note: DMI Interface and PCI Express masters are not allowed to access the SMM space.

5.5.1 SMM Space Definition

SMM space is defined by its **addressed** SMM space and its DRAM SMM space. The addressed SMM space is defined as the range of bus addresses used by the processor to access SMM space. DRAM SMM space is defined as the range of physical DRAM memory locations containing the SMM code. SMM space can be accessed at one of three transaction address ranges: Compatible, High, and TSEG. The Compatible and TSEG SMM space is not remapped and therefore the addressed and DRAM SMM space is the same address range. Since the High SMM space is remapped the addressed and DRAM SMM space is a different address range. Note that the High DRAM space is the same as the Compatible Transaction Address space. [Table 5-1](#) describes three unique address ranges:

- Compatible Transaction Address
- High Transaction Address
- TSEG Transaction Address

Table 5-1. Transaction Address Ranges – Compatible, High, and TSEG

SMM Space Enabled	Transaction Address Space	DRAM Space (DRAM)
Compatible	000A_0000h to 000B_FFFFh	000A_0000h to 000B_FFFFh
High	FEDA_0000h to FEDB_FFFFh	000A_0000h to 000B_FFFFh
TSEG	(TOLM-STOLEN-TSEG) to TOLM-STOLEN	(TOLM-STOLEN-TSEG) to TOLM-STOLEN

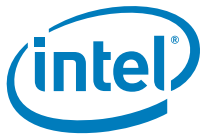

5.5.2 SMM Space Restrictions

If any of the following conditions are violated the results of SMM accesses are unpredictable and may cause the system to hang:

1. The Compatible SMM space **must not** be set-up as cacheable.
2. High or TSEG SMM transaction address space **must not** overlap address space assigned to system DRAM, or to any "PCI" devices (including DMI Interface, and PCI Express, and graphics devices). This is a BIOS responsibility.
3. Both D_OPEN and D_CLOSE **must not** be set to 1 at the same time.
4. When TSEG SMM space is enabled, the TSEG space **must not** be reported to the OS as available DRAM. This is a BIOS responsibility.
5. Any address translated through the GMADR TLB must not target DRAM from A_0000h–F_FFFFh.

5.5.3 SMM Space Combinations

When High SMM is enabled (G_SMROME=1 and H_SMRAM_EN=1) the Compatible SMM space is effectively disabled. Processor originated accesses to the Compatible SMM space are forwarded to PCI Express if VGAEN=1 (also depends on MDAP), otherwise they are forwarded to the DMI Interface. PCI Express and DMI Interface originated accesses are **never** allowed to access SMM space.

Table 5-2. SMM Space Table

Global Enable G_SMROME	High Enable H_SMRAM_EN	TSEG Enable TSEG_EN	Compatible (C) Range	High (H) Range	TSEG (T) Range
0	X	X	Disable	Disable	Disable
1	0	0	Enable	Disable	Disable
1	0	1	Enable	Disable	Enable
1	1	0	Disabled	Enable	Disable
1	1	1	Disabled	Enable	Enable

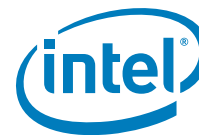

5.5.4 SMM Control Combinations

The G_SMFRAME bit provides a global enable for all SMM memory. The D_OPEN bit allows software to write to the SMM ranges without being in SMM mode. BIOS software can use this bit to initialize SMM code at powerup. The D_LCK bit limits the SMM range access to only SMM mode accesses. The D_CLS bit causes SMM (both CSEG and TSEG) data accesses to be forwarded to the DMI Interface or PCI Express. The SMM software can use this bit to write to video memory while running SMM code out of DRAM.

Table 5-3. SMM Control Table

G_SMFRAME	D_LCK	D_CLS	D_OPEN	Processor in SMM Mode	SMM Code Access	SMM Data Access
0	x	X	x	x	Disable	Disable
1	0	X	0	0	Disable	Disable
1	0	0	0	1	Enable	Enable
1	0	0	1	x	Enable	Enable
1	0	1	0	1	Enable	Disable
1	0	1	1	x	Invalid	Invalid
1	1	X	x	0	Disable	Disable
1	1	0	x	1	Enable	Enable
1	1	1	x	1	Enable	Disable

5.5.5 SMM Space Decode and Transaction Handling

Only the processor is allowed to access SMM space. PCI Express and DMI Interface originated transactions are not allowed to SMM space.

5.5.6 Processor WB Transaction to an Enabled SMM Address Space

Processor Writeback transactions (REQa[1]# = 0) to enabled SMM Address Space must be written to the associated SMM DRAM even though D_OPEN=0 and the transaction is not performed in SMM mode. This ensures SMM space cache coherency when cacheable extended SMM space is used.

5.5.7 SMM Access Through GTT TLB

Accesses through GTT TLB address translation to enabled SMM DRAM space are not allowed. Writes will be routed to Memory address 000C_0000h with byte enables de-asserted and reads will be routed to Memory address 000C_0000h. If a GTT TLB translated address hits enabled SMM DRAM space, an error is recorded in the PGTBL_ER register.

PCI Express and DMI Interface originated accesses are **never** allowed to access SMM space directly or through the GTT TLB address translation. If a GTT TLB translated address hits enabled SMM DRAM space, an error is recorded in the PGTBL_ER register.

PCI Express and DMI Interface write accesses through GMADR range will be snooped. Accesses to GMADR linear range (defined using fence registers) are supported. PCI Express and DMI Interface tileY and tileX writes to GMADR are not supported. If, when translated, the resulting physical address is to enabled SMM DRAM space, the request will be remapped to address 000C_0000h with de-asserted byte enables.

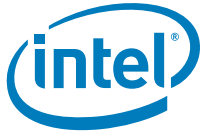

PCI Express and DMI Interface read accesses to the GMADR range are not supported therefore will have no address translation concerns. PCI Express and DMI Interface reads to GMADR will be remapped to address 000C_0000h. The read will complete with UR (unsupported request) completion status.

GTT Fetches are always decoded (at fetch time) to ensure not in SMM (actually, anything above base of TSEG or 640 KB – 1 MB). Thus, they will be invalid and go to address 000C_0000h, but that isn't specific to PCI Express or DMI; it applies to processor or internal graphics engines. Also, since the GMADR snoop would not be directly to the SMM space, there wouldn't be a writeback to SMM. In fact, the writeback would also be invalid (because it uses the same translation) and go to address 000C_0000h.

5.6 Memory Shadowing

Any block of memory that can be designated as read-only or write-only can be “shadowed” into Processor DRAM memory. Typically this is done to allow ROM code to execute more rapidly out of main DRAM. ROM is used as a read-only during the copy process while DRAM at the same time is designated write-only. After copying, the DRAM is designated read-only so that ROM is shadowed. Processor bus transactions are routed accordingly.

5.7 IIO Address Map Notes

5.7.1 Memory Recovery

When software recovers an underlying DRAM memory region that resides below the 4-GB address line that is used for system resources like firmware, local APIC, and so forth, (the gap below 4-GB address line), it needs to make sure that it does not create system memory holes whereby all the system memory cannot be decoded with two contiguous ranges. It is OK to have unpopulated addresses within these contiguous ranges that are not claimed by any system resource. IIO decodes all inbound accesses to system memory using two contiguous address ranges (0–TOLM, 4 GB–TOHM) and there cannot be holes created inside of those ranges that are allocated to other system resources in the gap below 4-GB address line. The only exception to this is the hole created in the low system DRAM memory range using the VGA memory address. IIO comprehends this and does not forward these VGA memory regions to system memory.

5.7.2 Non-Coherent Address Space

IIO supports one coarse main memory range which can be treated as non-coherent by IIO, that is, inbound accesses to this region are treated as non-coherent. This address range has to be a subset of one of the coarse memory ranges that IIO decodes towards system memory. Inbound accesses to the NC range are not snooped on Intel QuickPath Interconnect.



5.8 IIO Address Decoding

In general, software needs to guarantee that for a given address there can only be a single target in the system. Otherwise, it is a programming error and results are undefined. The one exception is that VGA addresses would fall within the inbound coarse decode memory range. The IIO inbound address decoder handles this conflict and forwards the VGA addresses to only the VGA port in the system (and not system memory).

5.8.1 Outbound Address Decoding

This section covers address decoding that IIO performs on a transaction from Intel QuickPath Interconnect/JTAG that targets one of the downstream devices/ports of the IIO. In the description in the rest of the section, PCIe refers to all of a standard PCI Express port and DMI, unless noted otherwise.

5.8.1.1 General Overview

- Before any transaction from Intel QuickPath Interconnect is validly decoded by IIO, the NodeID in the incoming transaction must match the NodeIDs assigned to the IIO (any exceptions are noted when required). Else it is an error.
- All target decoding toward PCIe, firmware and internal IIO devices follow address based routing. Address based routing follows the standard PCI tree hierarchy routing
- No NodeID based routing is supported south of the Intel QuickPath Interconnect port in IIO
- Subtractive decode port in IIO is the port that is a) the recipient of all addresses that are not positively decoded towards any of the valid targets in the IIO and b) the recipient of all message/special cycles that are targeted at the legacy PCH.
 - In the processor, the DMI is always the subtractive port. Virtual peer-to-peer bridge decoding related registers with their associated control bits (for example, VGAEN bit) and other misc address ranges (I/OxAPIC) of a DMI port are NOT valid (and ignored by the IIO decoder) when it is set as the subtractive decoding port. Subtractive decode transactions are forwarded to the legacy DMI port, irrespective of the setting of the MSE/IOSE bits in that port.
- Unless specified otherwise, all addresses (no distinction made) are first positively decoded against all target address ranges. Valid targets are PCIe, DMI, CSR and Perf Mon device. Software has the responsibility to make sure that only one target can ultimately be the target of a given address and IIO will forward the transaction towards that target.
 - For outbound transactions, when no target is positively decoded, the transactions are sent to the downstream DMI port if it is indicated as the subtractive decode port. In the processor, the DMI is always the subtractive decode port.
 - For inbound transactions on the processor, when no target is positively decoded, the transactions are sent to the subtractive decode port which is DMI.
- For positive decoding, the memory decode to each PCIe target is governed by Memory Space Enable (MSE) bit in the device PCI configuration space and I/O decode is covered by the I/O Space Enable bit in the device PCI configuration space. The only exceptions to this rule are the per port (external) I/OxAPIC address range which are decoded irrespective of the setting of the memory space enable



bit. There is no decode enable bit for configuration cycle decoding towards either a PCIe port or the internal CSR configuration space of IIO.

- The target decoding for internal VTdCSR space is based on whether the incoming CSR address is within the VTdCSR range (limit is 8K plus the base, VTBAR).
- Each PCIe/DMI port in IIO has one special address range - I/OxAPIC
- No loopback supported, that is, a transaction originating from a port is never sent back to the same port and the decode ranges of originating port are ignored in address decode calculations

5.8.1.2 FWH Decoding

This section talks about how IIO allows for access to flash memory that is resident below the IIO.

- FWH accesses using an IIO are allowed only from Intel QuickPath Interconnect. No accesses from JTAG/PCIe
- IIO indicates presence of bootable FWH to processor if it is with a FWH that contains the boot code below the legacy PCH connected to it
- All FWH addresses (4 GB:4 GB–16 MB) and (1 MB:1 MB – 128 K) that do not positively decode to IIO's PCIe ports, are subtractively forwarded to its legacy decode port.
- When IIO receives a transaction from Intel QuickPath Interconnect within 4 GB:4 GB–16 MB or 1 MB:1 MB–128 K and there is no positive decode hit against any of the other valid targets (if there is a positive decode hit to any of the other valid targets, the transaction is sent to that target), then the transaction is forwarded to DMI.

5.8.1.3 Other Outbound Target Decoding

- Other address ranges (besides CSR, FWH, I/OxAPIC) that need to be decoded per PCIe/DMI port include the standard peer-to-peer bridge decode ranges (MMIOL, MMIOH, I/O, VGA, CONFIG). Refer to *PCI-PCI Bridge 1.2 Specification* and *PCI Express Base Specification* for details. These ranges are also summarized in [Table 5-4](#).
- VTCSR
 - Remote peer-to-peer accesses from Intel QuickPath Interconnect that target VTCSR region are not completely aborted by IIO. If inbound protection is needed, VTd translation table should be used to protect at the source IIO. If the VTd table is not enabled, a Generic Protected Memory Range could be used to protect. A last defense is to turn off IB peer-to-peer MMIO. The remote peer-to-peer support is an issue not yet closed completely yet.
 - Remote peer-to-peer PCI configuration transactions from Intel QuickPath Interconnect that target the internal bus number of IIO (regardless of device number) are aborted by IIO.



5.8.1.4 Summary of Outbound Target Decoder Entries

Table 5-4 provides a list of all the target decoder entries in IIO, such as PCIe port, required by the outbound target decoder to positively decode towards a target.

Table 5-4. Outbound Target Decoder Entries

Address Region	Target Decoder Entry	Comments
VGA (Memory space A_0000h–B_FFFFh and I/O space 3B0h–3BBh and 3C0h–3DFh)	4+1 ¹	Fixed.
TPM/TXT/FW ranges (E/F segs and 4 G–16 M to 4 G)	1	Fixed.
MMIOL	4	Variable. From peer-to-peer Bridge Configuration Register Space
MMIOH	4	Variable. From peer-to-peer Bridge Configuration Register Space (upper 32 bits PM BASE/LIMIT)
CFGBUS	1	Legacy IIO internal bus number should be set to bus 0.
	4	Variable. From peer-to-peer Bridge Configuration Register Space for PCIe bus number decode.
VTBAR	1	Variable. Decodes the Intel VT-d chipset registers.
IO	4	Variable. From four local peer-to-peer Bridge Configuration Register Space of the PCIe port.

Notes:

- This is listed as 4+1 entries because each of the 4 local peer-to-peer bridges have their own VGA decode enable bit and local IIO has to comprehend this bit individually for each port, and local IIO's QPIPVGASAD.Valid bit is used to indicate the dual IIO has VGA port or not.

5.8.1.5 Summary of Outbound Memory/IO/Configuration Decoding

Throughout the tables in this section, a reference to a PCIe port generically refers to a standard PCIe port or a DMI port.

Note: Integrated I/O Module will support configurations cycles that originate only from the processor. It may support inbound CFG for debug only.

Table 5-5. Decoding of Outbound Memory Requests from Intel® QuickPath Interconnect (from processor or remote Peer-to-Peer)

Address Range	Conditions	IIO Behavior
CB DMA BAR, I/OxAPIC BAR, ABAR, VTBAR	CB_BAR, ABAR, MBAR, VTBAR and remote peer-to-peer access	Completer Abort
	CB_BAR, ABAR, MBAR, VTBAR and not remote peer-to-peer access	Forward to that target
TPM, FED4_0xxx - FED4_7xxx	Processor has no Intel TPM.	Forward to DMI as TXT_* cycle assuming Intel TPM is not supported.
All other memory accesses	! (CB_BAR, ABAR, MBAR, VTBAR, TPM) and one of the downstream ports positively claimed the address	Forward to that port
	! (CB_BAR, ABAR, MBAR, VTBAR, TPM) and none of the downstream ports positively claimed the address and DMI is the subtractive decode port	Forward to DMI
	! (CB_BAR, ABAR, MBAR, VTBAR, TPM) and none of the downstream ports positively claimed the address and DMI is not the subtractive decode port	Master Abort

Table 5-6 details IIO behavior for configuration requests from Intel QuickPath Interconnect and peer-to-peer completions from Intel QuickPath Interconnect.

Table 5-6. Decoding of Outbound Configuration Requests (from Processor or Peer-to-Peer) from Intel® QuickPath Interconnect and Decoding of Outbound Peer-to-Peer Completions from Intel QuickPath Interconnect

Address Range	Conditions	IIO Behavior
Bus 0	Bus 0 and legacy IIO and device number matches one of internal device numbers	Forward to that internal device.
	Bus 0 and legacy IIO and device number does NOT match one of IIO's internal device numbers	Forward to the downstream subtractive decode port, that is, the legacy DMI port If the transaction is a configuration request, the request is forwarded as a Type 0 ¹ configuration transaction to the subtractive decode port
	Bus 0 and NOT legacy IIO	Master Abort
Bus 1–255	Bus 1–255 and it matches the IIOBUSNO and device number matches one of IIO's internal device numbers	Forward to that internal device.
	Bus 1–255 and it matches the IIOBUSNO and device number does NOT match any of IIO's internal device numbers	Master Abort
	Bus 1–255 and it does not match the IIOBUSNO but positively decodes to one of the downstream PCIe ports	Forward to that port. Configuration requests are forwarded as a Type 0 ² (if bus number matches secondary bus number of port) or a Type 1.
	Bus 1–255 and it does not match the IIOBUSNO and does not positively decode to one of the downstream PCIe ports and DMI is the subtractive decode port	Forward to DMI ³ . Forward configuration request as Type 0/1, depending on secondary bus number register of the port.
	Bus 1–255 and it does not match the IIOBUSNO and does not positively decode to one of the downstream PCIe ports and DMI is not the subtractive decode port	Master Abort

Notes:

- Note that when forwarding to DMI, Type 0 transaction with any device number is required to be forwarded by IIO (unlike the standard PCI Express root ports)
- If a downstream port is a standard PCI Express root port, then PCI Express specification requires that all non-zero-device numbered Type0 transactions are master aborted by the root port. If the downstream port is non-legacy DMI, then Type 0 transaction with any device number is allowed/forwarded.
- Note that when forwarding to DMI, Type 0 transaction with any device number is required to be forwarded by IIO (unlike the standard PCI Express root ports).

Table 5-7 details IIO behavior when no target has been positively decoded for an outgoing I/O transaction from Intel QuickPath Interconnect Inbound Address Decoding.

Table 5-7. Subtractive Decoding of Outbound I/O Requests from Intel® QuickPath Interconnect

Address Range	Conditions	IIO Behavior
Any I/O address not positively decoded	No valid target decoded and one of the downstream ports is the subtractive decode port	Forward to downstream subtractive decode port
	No valid target decoded and none of the downstream ports is the subtractive decode port	Master Abort



5.8.2 Inbound Address Decoding

This section covers the decoding that is done on any transaction that is received on a PCIe or DMI.

5.8.2.1 Overview

- All inbound addresses that fall above the top of Intel QuickPath Interconnect physical address limit are flagged as errors by IIO. Top of Intel QuickPath Interconnect physical address limit is dependent on the Intel QuickPath Interconnect profile.
- Inbound decoding towards main memory in IIO happens in two steps. The first step involves a 'coarse decode' towards main memory using two separate system memory window ranges (0–TOLM, 4 GB–TOHM) that can be setup by software. These ranges are non-overlapping. The second step is the fine source decode towards an individual socket using the Intel QuickPath Interconnect memory source address decoders.
 - A sub-region within one of the two coarse regions can be marked as non-coherent
 - VGA memory address would overlap one of the two main memory ranges and IIO decoder is cognizant of that and steers these addresses towards the VGA device of the system
- Inbound peer-to-peer decoding also happens in two steps. The first step involves decoding peer-to-peer not crossing Intel QuickPath Interconnect (local peer-to-peer). The second step involves actual target decoding for local peer-to-peer (if transaction targets another device south of the IIO).
 - A pair of base/limit registers are provided for IIO to positively decode local peer-to-peer transactions.
 - On the processor, the global pair must be set to be the same as local, so the second pair of base/limit registers do not add any functionality.

Note: The processor IIO supports peer-to-peer writes, interrupt messages for legacy interrupt and GPE (Please see section on Platform Interrupts in the Interrupt Chapter for more details). The processor IIO does not support peer-to-peer reads.

- Fixed VGA memory addresses (A0000h–BFFFFh) are always peer-to-peer addresses and would reside outside of the global peer-to-peer memory address ranges mentioned above. The VGA memory addresses also overlap one of the system memory address regions, but IIO always treats the VGA addresses as peer-to-peer addresses. VGA I/O addresses (3B0h–3BBh, 3C0h–3DFh) always are forwarded to the VGA I/O agent of the system. IIO performs only 16-bit VGA I/O address decode inbound.
- Subtractively decoded inbound addresses are forwarded to the subtractive decode port of the IIO.
- Inbound accesses to ME host visible devices (HECI, HECI2, IDER, and KT; Dev18, Fun0-3) are allowed and will not be blocked by IIO.
- Inbound accesses to FWH, TPM, VTCSR, CPUCSR and CPULocalCSR are blocked by IIO (completer aborted).

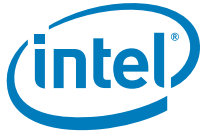

5.8.2.2 Summary of Inbound Address Decoding

Table 5-8 summarizes IIO behavior on inbound memory transactions from any PCIe port. Note that this table is only intended to show the routing of transactions based on the address and is not intended to show the details of several control bits that govern forwarding of memory requests from a given PCIe Express port. Refer to the *PCI Express Base Specification 2.0* and the registers chapter for details of these control bits.

Table 5-8. Inbound Memory Address Decoding (Sheet 1 of 2)

Address Range	Conditions	IIO Behavior
DRAM	Address in Intel ME range in DRAM, class TCm over DMI	Forward to Intel QuickPath Interconnect
	Address in Intel ME range in DRAM, not class TCm over DMI	Master Abort
	Address outside Intel ME range in DRAM, class TCm over DMI	Master Abort
	Address in Intel ME range in DRAM and any class over PCIe	Master Abort
	Address within 0: TOLM or 4 GB: TOHM and SAD hit	Forward to Intel QuickPath Interconnect
Interrupts	Address within FEE00000h–FEEFFFFFFh and write	Forward to Intel QuickPath Interconnect
	Address within FEE00000h–FEEFFFFFFh and read	UR Response
TPM/HPET, I/OxAPIC, CPUCSR when enabled, CPU LocalCSR, privileged CSR, INTA/Rsvd, TSEG, Relocated CSeg, On-die ROM, FWH, VTBAR ¹ (when enabled), Protected VT-d range Low and High, Generic Protected dram range, CB DMA and I/OxAPIC BARs ²	<ul style="list-style-type: none"> • FC00000h–FEDFFFFFFh or FEF00000h–FFFFFFFh • VTBAR • VT-d_Prot_High • VT-d_Prot_Low • Generic_Prot_DRAM • CB DMA BAR • I/OxAPIC ABAR and MBAR 	Completer Abort
VGA ³	Address within 0A0000h–0BFFFFFFh and main switch SAD is programmed to forward VGA	Forward to Intel QuickPath Interconnect
	Address within 0A0000h–0BFFFFFFh and main switch SAD is NOT programmed to forward VGA and one of the PCIe has VGAEN bit set	Forward to the PCIe port
	Address within 0A0000h–0BFFFFFFh and main switch SAD is NOT programmed to forward VGA and none of the PCIe has VGAEN bit set and DMI port is the subtractive decoding port	Forward to DMI
	Address within 0A0000h–0BFFFFFFh and main switch SAD is NOT programmed to forward VGA and none of the PCIe ports have VGAEN bit set and DMI is not the subtractive decode port	Master abort

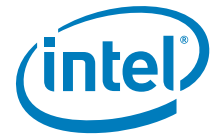

Table 5-8. Inbound Memory Address Decoding (Sheet 2 of 2)

Address Range	Conditions	IIO Behavior
Other Peer-to-Peer ⁴	Address within LMMIOL.BASE/LMMIOL.LIMIT or LMMIOH.BASE/LMMIOH.LIMIT and a PCIe port positively decoded as target	Forward to the PCI Express port
	Address within LMMIOL.BASE/LMMIOL.LIMIT or LMMIOH.BASE/LMMIOH.LIMIT and no PCIe port positively decoded as target	Forward to DMI
	Address NOT within LMMIOL.BASE/LMMIOL.LIMIT or LMMIOH.BASE/LIOH.LIMIT, but is within GMMIOL.BASE/GMMIOL.LIMIT or GMMIOH.BASE/GMMIOH.LIMIT	Forward to Intel QuickPath Interconnect For the processor, this is not applicable as GMMIOH and LMMIOH must be programmed to the same values.
DRAM Memory holes and other non-existent regions	<ul style="list-style-type: none"> { 4G ≤ Address ≤ TOHM (OR) 0 ≤ Address ≤ TOLM } AND address does not decode to any socket in Intel QuickPath Interconnect source decoder Address > TOCM When Intel VT-d translation enabled, and guest address greater than 2[^]GPA_LIMIT 	Master Abort
All Else		Forward to subtractive decode port.

Notes:

- Note that VTBAR range would be within the MMIOH range of that IIO. And by that token, VTBAR range can never overlap with any DRAM ranges.
- The CB DMA BAR and I/OxAPIC MBAR regions of an IIO overlap with MMIOH/MMIOH ranges of that IIO.
- CB DMA does not support generating memory accesses to the VGA memory range and it will abort all transactions to that address range. Also, if peer-to-peer memory read disable bit is set, VGA memory reads are aborted.
- If peer-to-peer memory read disable bit is set, then peer-to-peer memory reads are aborted.

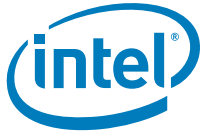

Table 5-9 summarizes I/O behavior on inbound I/O transactions from any PCIe port.

Table 5-9. Inbound I/O Address Decoding

Address Range	Conditions	I/O Behavior
Any	Inbound I/O is disabled	Master Abort
VGA	Address within 3B0h–3BBh, 3C0h–3DFh and inbound I/O is enabled ¹ and (main switch SAD is programmed to forward VGA OR address not within local peer-to-peer I/O base/limit range but within global peer-to-peer I/O base/limit range)	Forward to Intel QuickPath Interconnect
	Address within 3B0h–3BBh, 3C0h–3DFh and inbound I/O is enabled and main switch SAD is NOT programmed to forward VGA and one of the PCIe ports has VGAEN bit set	Forward to that PCIe port
	Address within 3B0h–3BBh, 3C0h–3DFh and inbound I/O is enabled and main switch SAD is NOT programmed to forward VGA and none of the PCIe has VGAEN bit set but is within the I/O base/limit range of one of the PCIe port	Forward to that PCIe port
	Address within 3B0h–3BBh, 3C0h–3DFh and inbound I/O is enabled and main switch SAD is NOT programmed to forward VGA and none of the PCIe has VGAEN bit set and is not within the I/O base/limit range of any of the PCIe ports and DMI is the subtractive decode port	Forward to DMI
	Address within 03B0h–3BBh, 3C0h–3DFh and inbound I/O is enabled and main switch SAD is NOT programmed to forward VGA and none of the PCIe has VGAEN bit set and is not within the base/limit range of any PCIe port and DMI port is not the subtractive decode port	Master abort
Other Peer-to-Peer	Address within LIO.BASE/LIO.LIMIT and inbound I/O is enabled and a PCIe port positively decoded as target	Forward to the PCI Express port
	Address within LIO.BASE/LIO.LIMIT and inbound I/O is enabled and no PCIe port positively decoded as target and DMI is the subtractive decode port	Forward to DMI
	Address within LIO.BASE/LIO.LIMIT and inbound I/O is enabled and no PCIe port decoded as target and DMI is not the subtractive decode port	Master Abort
	Inbound I/O is enabled and address NOT within LIO.BASE/LIO.LIMIT but is within GIO.BASE/GIO.LIMIT	Forward to Intel QuickPath Interconnect
Non-existent Addresses	Address ≥ 64 KB	Master Abort
All Else		Forward to subtractive decode port.

Notes:

1. Inbound I/O is enabled using CSRMISCCTRLSTS[30].

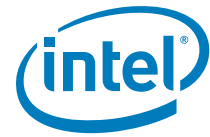

Table 5-10 summarizes IIO behavior on inbound configuration transactions from any PCIe port.

Table 5-10. Inbound Configuration Request Decoding

Transaction Type	Conditions	IIO Behavior
Type 0	N/A	Master Abort
Type 1	Inbound Configuration disabled	Master Abort
	Inbound Configuration enabled (by MISCCTRLSTS[1]) and bus 0	Master Abort
	Inbound Configuration enabled and bus is between 1–255 and Bus number matches the internal bus number of IIO (IIOBUSNO or PBN register)	Master Abort
	Inbound Configuration enabled and bus is between 1–255 and Bus number does not match the internal bus number of IIO (IIOBUSNO or PBN register) and bus number is outside of LCFGBUS.BASE/LCFGBUS.LIMIT and inside of GCFGBUS.BASE/GCFGBUS.LIMIT	Forward to Intel QuickPath Interconnect
	Inbound Configuration enabled and bus is between 1–255 and Bus number does not match the internal bus number of IIO (IIOBUSNO or PBN register) and bus number is outside of GCFGBUS.BASE/GCFGBUS.LIMIT	Forward to subtractive decode port (DMI or Intel QuickPath Interconnect), if enabled using MISCCTRLSTS[1]
	Inbound Configuration enabled and bus is between 1–255 and Bus number does not match the internal bus number of IIO (IIOBUSNO or PBN register) and is within LCFGBUS.BASE/LCFGBUS.LIMIT and one of the PCIe ports is positively decoded	Forward to that PCIe port. Forward as Type 0/1 depending on secondary bus number of the port.
	Inbound Configuration enabled and bus is between 1–255 and Bus number does not match the internal bus number of IIO (IIOBUSNO or PBN register) and is within LCFGBUS.BASE/LCFGBUS.LIMIT and none of the PCIe ports is positively decoded and DMI is the subtractive decode port	Forward to DMI Forward as Type 0 ¹ /1 depending on secondary bus number of the port.
	Inbound Configuration enabled and bus is between 1–255 and Bus number does not match the internal bus number of IIO (IIOBUSNO or PBN register) and is within LCFGBUS.BASE/LCFGBUS.LIMIT and none of the PCIe ports is positively decoded and DMI is not the subtractive decode port	Master Abort

Notes:

1. When forwarding Type 0 accesses to DMI, any device number in the configuration transaction is allowed/forwarded.



5.8.3 Intel® VT-d Address Map Implications

Intel VT-d applies only to inbound memory transactions. Inbound I/O and configuration transactions are not affected by Intel VT-d. Inbound I/O, configuration and message decode and forwarding happens the same whether Intel VT-d is enabled or not. For memory transaction decode, the host address map in Intel VT-d corresponds to the address map discussed earlier in the chapter and all addresses after translation are subject to the same address map rule checking (and error reporting) as in the non-Intel VT-d mode. There is not a fixed guest address map that IIO Intel VT-d hardware can rely upon (except that the guest domain addresses cannot go beyond the guest address width specified using the GPA_LIMIT register); that is, it is OS dependent. IIO converts all incoming memory guest addresses to host addresses and then applies the same set of memory address decoding rules as described earlier. In addition to the address map and decoding rules previously discussed, IIO also supports an additional memory range called the VTBAR range and this range is used to handle accesses to Intel VT-d related chipset registers. Only aligned DWord/QWord accesses are allowed to this region. Only outbound and SMBus/JTAG accesses are allowed to this range and also these can only be accesses outbound from Intel QuickPath Interconnect. *Inbound accesses to this address range are completely aborted by the IIO.*

§