

# Intel® Desktop Board D865PCD Product Guide

---

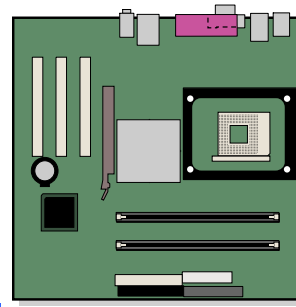

Order Number: C68341-001

# Revision History

---

| Revision | Revision History   | Date       |
|----------|--|------------|
| -001     | Final version of the Intel® Desktop Board D865PCD Product Guide. | March 2004 |

If an FCC declaration of conformity marking is present on the board, the following statement applies:

## FCC Declaration of Conformity

This device complies with Part 15 of the FCC Rules. Operation is subject to the following two conditions: (1) this device may not cause harmful interference, and (2) this device must accept any interference received, including interference that may cause undesired operation.

For questions related to the EMC performance of this product, contact:

Intel Corporation  
5200 N.E. Elam Young Parkway  
Hillsboro, OR 97124  
1-800-628-8686

This equipment has been tested and found to comply with the limits for a Class B digital device, pursuant to Part 15 of the FCC Rules. These limits are designed to provide reasonable protection against harmful interference in a residential installation. This equipment generates, uses, and can radiate radio frequency energy and, if not installed and used in accordance with the instructions, may cause harmful interference to radio communications. However, there is no guarantee that interference will not occur in a particular installation. If this equipment does cause harmful interference to radio or television reception, which can be determined by turning the equipment off and on, the user is encouraged to try to correct the interference by one or more of the following measures:

- Reorient or relocate the receiving antenna.
- Increase the separation between the equipment and the receiver.
- Connect the equipment to an outlet on a circuit other than the one to which the receiver is connected.
- Consult the dealer or an experienced radio/TV technician for help.

Any changes or modifications to the equipment not expressly approved by Intel Corporation could void the user's authority to use the equipment.

## Canadian Department of Communications Compliance Statement

This digital apparatus does not exceed the Class B limits for radio noise emissions from digital apparatus set out in the Radio Interference Regulations of the Canadian Department of Communications.

Le présent appareil numérique n'émet pas de bruits radioélectriques dépassant les limites applicables aux appareils numériques de la classe B prescrites dans le Règlement sur le brouillage radioélectrique édicté par le ministère des Communications du Canada.

## Disclaimer

Information in this document is provided in connection with Intel® products. No license, express or implied, by estoppel or otherwise, to any intellectual property rights is granted by this document. Except as provided in Intel's Terms and Conditions of Sale for such products, Intel assumes no liability whatsoever, and Intel disclaims any express or implied warranty, relating to sale and/or use of Intel products including liability or warranties relating to fitness for a particular purpose, merchantability, or infringement of any patent, copyright or other intellectual property right. Intel products are not intended for use in medical, life saving, or life sustaining applications. Intel may make changes to specifications and product descriptions at any time, without notice.

Desktop Board D865PCD may contain design defects or errors known as errata which may cause the product to deviate from published specifications. Current characterized errata are available on request.

Contact your local Intel sales office or your distributor to obtain the latest specifications and before placing your product order.

Copies of documents which have an ordering number and are referenced in this document, or other Intel literature, may be obtained from Intel Corporation by going to the World Wide Web site at: <http://www.intel.com/> or by calling 1-800-548-4725.

Intel, Pentium, and Celeron are registered trademarks of Intel Corporation or its subsidiaries in the United States and other countries.

\* Other names and brands may be claimed as the property of others.

Copyright © 2004, Intel Corporation. All rights reserved.

# Preface

---

This Product Guide gives information about board layout, component installation, BIOS Setup menus, and regulatory requirements for Intel® Desktop Board D865PCD.

## Intended Audience

The Product Guide is intended for technically qualified personnel.

## Information Layout

The chapters in this Product Guide are arranged as follows:

- 1 Desktop Board Features: a summary of product features.
- 2 Installing and Replacing Desktop Board Components: instruction on how to install the desktop board and other hardware components.
- 3 Updating the BIOS: instructions on how to update the BIOS.
- 4 Using the BIOS Setup Program: contents of the BIOS Setup menus and submenus.
- 5 Desktop Board Resources: Memory map, DMA channels, and interrupts.
- A Error Messages and Indicators: BIOS error messages and beep codes.
- B Regulatory Compliance: Regulatory compliance information.

## Conventions

The following conventions are used in this manual:



### **WARNING**

*Warnings indicate conditions that, if not observed, can cause personal injury.*



### **CAUTION**

*Cautions warn the user about how to prevent damage to hardware or loss of data.*



### **NOTE**

*Notes call attention to important information.*

## Notations

| <b>Term</b> | <b>Description</b>   |
|-------------|--|
| GB          | Gigabyte (1,073,741,824 bytes)   |
| KB          | Kilobyte (1024 bytes)  |
| MB          | Megabyte (1,048,576 bytes)   |
| Mbit        | Megabit (1,048,576 bits)   |
| MHz         | Megahertz (one million hertz)  |
| *           | Third-party brands and names that are the property of their respective owners. |

# Contents

---

|  |    |
|--|----|
| <b>1 Desktop Board Features</b> .....                            | 11 |
| Supported Operating Systems.....                                 | 12 |
| Desktop Board Components.....                                    | 13 |
| Processor.....   | 15 |
| Main Memory.....   | 16 |
| Intel® 865P Chipset.....   | 17 |
| Graphics Subsystem.....  | 17 |
| Audio Subsystem.....   | 17 |
| LAN Subsystem.....   | 17 |
| LAN Subsystem Software.....                                      | 17 |
| RJ-45 LAN Connector LEDs.....                                    | 18 |
| Input/Output (I/O) Controller.....                               | 18 |
| Hi-Speed USB 2.0 Support.....                                    | 18 |
| Enhanced IDE Interface.....                                      | 19 |
| Accelerated Graphics Port (AGP).....                             | 19 |
| BIOS.....  | 19 |
| PCI Auto Configuration.....                                      | 19 |
| IDE Auto Configuration.....                                      | 19 |
| Security Passwords.....  | 20 |
| Chassis Intrusion.....   | 20 |
| Power Management Features.....                                   | 20 |
| ACPI.....  | 20 |
| Power Connectors.....  | 20 |
| Fan Connectors.....  | 21 |
| Suspend to RAM (Instantly Available PC Technology).....          | 21 |
| Resume on Ring.....  | 21 |
| Wake from USB.....   | 21 |
| Wake from PS/2 Keyboard/Mouse.....                               | 21 |
| PME# Wakeup Support.....   | 22 |
| Speaker.....   | 22 |
| Battery.....   | 22 |
| Real-Time Clock.....   | 22 |
| <b>2 Installing and Replacing Desktop Board Components</b> ..... | 23 |
| Before You Begin.....  | 23 |
| Installation Precautions.....                                    | 24 |
| Installation Instructions.....                                   | 24 |
| Ensure Electromagnetic Compatibility (EMC) Compliance.....       | 24 |
| Chassis and Component Certifications.....                        | 25 |
| Prevent Power Supply Overload.....                               | 25 |
| Place Battery Marking.....                                       | 25 |
| Use Only for Intended Applications.....                          | 26 |
| Installing the I/O Shield.....                                   | 26 |

|   |           |
|---|-----------|
| Installing and Removing the Desktop Board .....                     | 27        |
| Installing and Removing a Processor .....                           | 28        |
| Installing a Processor .....  | 28        |
| Installing the Processor Fan Heat Sink .....                        | 28        |
| Connecting the Processor Fan Heat Sink Cable .....                  | 29        |
| Removing the Processor .....  | 29        |
| Installing and Removing Memory .....                                | 30        |
| Installing DIMMs .....  | 31        |
| Removing DIMMs .....  | 31        |
| Installing and Removing an AGP Card .....                           | 32        |
| Installing an AGP Card .....  | 32        |
| Removing the AGP Card .....   | 32        |
| Connecting the IDE Cable .....                                      | 33        |
| Connecting Internal Headers .....                                   | 34        |
| Connecting the Front Panel Header .....                             | 35        |
| Connecting the USB 2.0 Header .....                                 | 35        |
| Installing a Front Panel Audio Solution .....                       | 36        |
| Connecting Hardware Control and Power Cables .....                  | 37        |
| Connecting the Chassis Intrusion Cable .....                        | 38        |
| Connecting Fans .....   | 38        |
| Connecting Power Supply Cables .....                                | 38        |
| Add-In Card and Peripheral Interface Connectors .....               | 39        |
| Setting the BIOS Configuration Jumper Block .....                   | 40        |
| Clearing BIOS Passwords .....                                       | 41        |
| Back Panel Connectors .....   | 42        |
| Replacing the Battery .....   | 43        |
| <b>3 Updating the BIOS .....</b>                                    | <b>47</b> |
| Updating the BIOS with the Intel® Express BIOS Update Utility ..... | 47        |
| Updating the BIOS with the Iflash Memory Update Utility .....       | 48        |
| Obtaining the BIOS Update File .....                                | 48        |
| Updating the BIOS .....   | 48        |
| Recovering the BIOS .....   | 49        |
| <b>4 Using the BIOS Setup Program .....</b>                         | <b>51</b> |
| Maintenance Menu .....  | 52        |
| Main Menu .....   | 53        |
| Advanced Menu .....   | 54        |
| PCI Configuration Submenu .....                                     | 55        |
| Boot Configuration Submenu .....                                    | 56        |
| Peripheral Configuration Submenu .....                              | 57        |
| ATA/IDE Configuration Submenu .....                                 | 59        |
| PATA Submenu .....  | 60        |
| Diskette Configuration Submenu .....                                | 62        |
| Event Log Configuration Submenu .....                               | 63        |
| Video Configuration Submenu .....                                   | 64        |
| USB Configuration Submenu .....                                     | 65        |
| Chipset Configuration Submenu .....                                 | 66        |
| Fan Control Submenu .....   | 68        |

|   |           |
|---|-----------|
| Security Menu .....                                     | 69        |
| Power Menu .....  | 70        |
| ACPI Submenu.....                                       | 71        |
| Boot Menu.....  | 72        |
| Boot Device Priority Submenu .....                      | 73        |
| Hard Disk Drives Submenu.....                           | 74        |
| Removable Devices Submenu.....                          | 75        |
| ATAPI CD-ROM Drives .....                               | 76        |
| Exit Menu .....   | 77        |
| <b>5 Desktop Board Resources .....</b>                  | <b>79</b> |
| Memory Map .....  | 79        |
| DMA Channels .....                                      | 79        |
| Interrupts.....   | 80        |
| <b>A Error Messages and Indicators .....</b>            | <b>81</b> |
| BIOS Beep Codes .....                                   | 81        |
| BIOS Error Messages.....                                | 82        |
| <b>B Regulatory Compliance .....</b>                    | <b>85</b> |
| Safety Regulations .....                                | 85        |
| European Union Declaration of Conformity Statement..... | 85        |
| Product Ecology Statements .....                        | 86        |
| EMC Regulations .....                                   | 87        |
| Product Certification Markings (Board Level).....       | 88        |

## Figures

|  |    |
|--|----|
| 1. Desktop Board D865PCD Components .....  | 13 |
| 2. Installing the I/O Shield .....   | 26 |
| 3. Location of Mounting Screw Holes .....  | 27 |
| 4. Installing a Processor .....  | 28 |
| 5. Connecting the Processor Fan Heat Sink Cable to the Processor Fan Connector ..... | 29 |
| 6. Installing a Memory Module .....  | 30 |
| 7. Removing the AGP Card .....   | 32 |
| 8. Connecting the IDE Cable .....  | 33 |
| 9. Internal Headers .....  | 34 |
| 10. Location of Hardware Control Headers and Power Connectors .....                  | 37 |
| 11. PCI Bus Add-in Card and Peripheral Interface Connectors .....                    | 39 |
| 12. Location of the BIOS Configuration Jumper Block .....                            | 40 |
| 13. Back Panel Connectors .....  | 42 |
| 14. Removing the Battery .....   | 46 |

## Tables

|   |    |
|---|----|
| 1. Feature Summary .....                                  | 11 |
| 2. Desktop Board Components .....                         | 14 |
| 3. Supported Processors .....                             | 15 |
| 4. RJ-45 10/100 Ethernet LAN Connector LEDs .....         | 18 |
| 5. Front Panel Header .....                               | 35 |
| 6. USB 2.0 Header .....                                   | 35 |
| 7. Front Panel Audio Header Signal Names .....            | 36 |
| 8. Jumper Settings for the BIOS Setup Program Modes ..... | 40 |
| 9. BIOS Setup Program Menu Bar .....                      | 51 |
| 10. BIOS Setup Program Function Keys .....                | 52 |
| 11. Maintenance Menu .....                                | 52 |
| 12. Main Menu .....                                       | 53 |
| 13. Advanced Menu .....                                   | 54 |
| 14. PCI Configuration Submenu .....                       | 55 |
| 15. Boot Configuration Submenu .....                      | 56 |
| 16. Peripheral Configuration Submenu .....                | 57 |
| 17. ATA/IDE Configuration Submenu .....                   | 59 |
| 18. PATA Submenus .....                                   | 60 |
| 19. Diskette Configuration Submenu .....                  | 62 |
| 20. Event Log Configuration Submenu .....                 | 63 |
| 21. Video Configuration Submenu .....                     | 64 |
| 22. USB Configuration Submenu .....                       | 65 |
| 23. Chipset Configuration Submenu .....                   | 66 |
| 24. Hardware Management .....                             | 68 |
| 25. Security Menu .....                                   | 69 |
| 26. Power Menu .....                                      | 70 |
| 27. ACPI Submenu .....                                    | 71 |
| 28. Boot Menu .....                                       | 72 |
| 29. Boot Device Priority Submenu .....                    | 73 |
| 30. Hard Disk Drives Submenu .....                        | 74 |



31. Removable Devices Submenu .....75  
32. ATAPI CD-ROM Drives Submenu.....76  
33. Exit Menu.....77  
34. System Memory Map .....79  
35. DMA Channels.....79  
36. Interrupts .....80  
37. Beep Codes .....81  
38. BIOS Error Messages .....82  
39. Safety Regulations.....85  
40. EMC Regulations.....87  
41. Product Certification Markings .....88



# 1 Desktop Board Features

This chapter describes the main features of Intel® Desktop Board D865PCD. Table 1 summarizes these features.

**Table 1. Feature Summary**

|                               |  |
|-------------------------------|--|
| <b>Form Factor</b>            | MicroATX at 9.6-inches by 9.6-inches   |
| <b>Processor</b>              | Support for: <ul style="list-style-type: none"> <li>• Intel® Pentium® 4 processor (2.2 GHz or higher) in an mPGA478-pin package with 533/400 MHz system bus</li> <li>• Intel® Celeron® processor (2.0 GHz or higher) in an mPGA478-pin package with 400 MHz system bus</li> </ul>  |
| <b>Main Memory</b>            | <ul style="list-style-type: none"> <li>• Two 184-pin, 2.5 V SDRAM Dual Inline Memory Module (DIMM) sockets</li> <li>• Dual channel 333/266 MHz DDR SDRAM interface</li> <li>• Designed to support up to 2 GB of system memory</li> </ul>   |
| <b>Chipset</b>                | Intel® 865P chipset consisting of: <ul style="list-style-type: none"> <li>• Intel® 82865P Memory Controller Hub (MCH) with Accelerated Hub Architecture (AHA) bus</li> <li>• Intel® 82801EB I/O Controller Hub (ICH5)</li> <li>• 4 Mbit Firmware Hub (FWH)</li> </ul>  |
| <b>Graphics</b>               | <ul style="list-style-type: none"> <li>• Intel 865P chipset</li> <li>• 1.5 V and 0.8 V only AGP connector</li> <li>• Single AGP port via the connector or integrated graphics</li> <li>• AGP 3.0 including 1x/4x/8x AGP data transfers and 1x/4x/8x Fast Writes</li> </ul>   |
| <b>Audio</b>                  | <ul style="list-style-type: none"> <li>• Intel 865P chipset (AC '97)</li> <li>• Realtek* audio codec</li> </ul>  |
| <b>LAN</b> (optional)         | Intel® Pro 10/100 Ethernet LAN (Intel® 82502EZ) and RJ-45 connector  |
| <b>Peripheral Interfaces</b>  | <ul style="list-style-type: none"> <li>• Up to six USB 2.0 ports <ul style="list-style-type: none"> <li>— Four ports routed to the back panel</li> <li>— Two ports routed to the internal USB header</li> </ul> </li> <li>• Two IDE interfaces with Ultra DMA-33 and ATA-66/100 support</li> <li>• One diskette drive interface</li> <li>• One parallel port</li> <li>• One serial port</li> <li>• One VGA port</li> <li>• PS/2* keyboard and mouse ports</li> </ul> |
| <b>Expansion Capabilities</b> | Three PCI bus add-in card connectors (SMBus routed to PCI bus 2)   |
| <b>BIOS</b>                   | <ul style="list-style-type: none"> <li>• Intel/AMI BIOS</li> <li>• 4 Mbit symmetrical flash memory</li> <li>• Support for SMBIOS</li> </ul>  |
| <b>Power Management</b>       | <ul style="list-style-type: none"> <li>• Support for Advanced Configuration and Power Interface (ACPI)</li> <li>• Suspend to RAM (STR)</li> <li>• Wake on USB, PCI, RS-232, PS/2, LAN, and front panel</li> </ul>  |

### Related Links

For more information about Intel Desktop Board D865PCD, including the Technical Product Specification (TPS), BIOS updates, and device drivers, go to:

<http://support.intel.com/support/motherboards/desktop/>

## Supported Operating Systems

The desktop board supports the following operating systems:

- Microsoft Windows\* 98 SE
- Microsoft Windows Me
- Microsoft Windows 2000 Professional
- Microsoft Windows XP Professional

## Desktop Board Components

Figure 1 shows the approximate location of the major components on Desktop Board D865PCD.

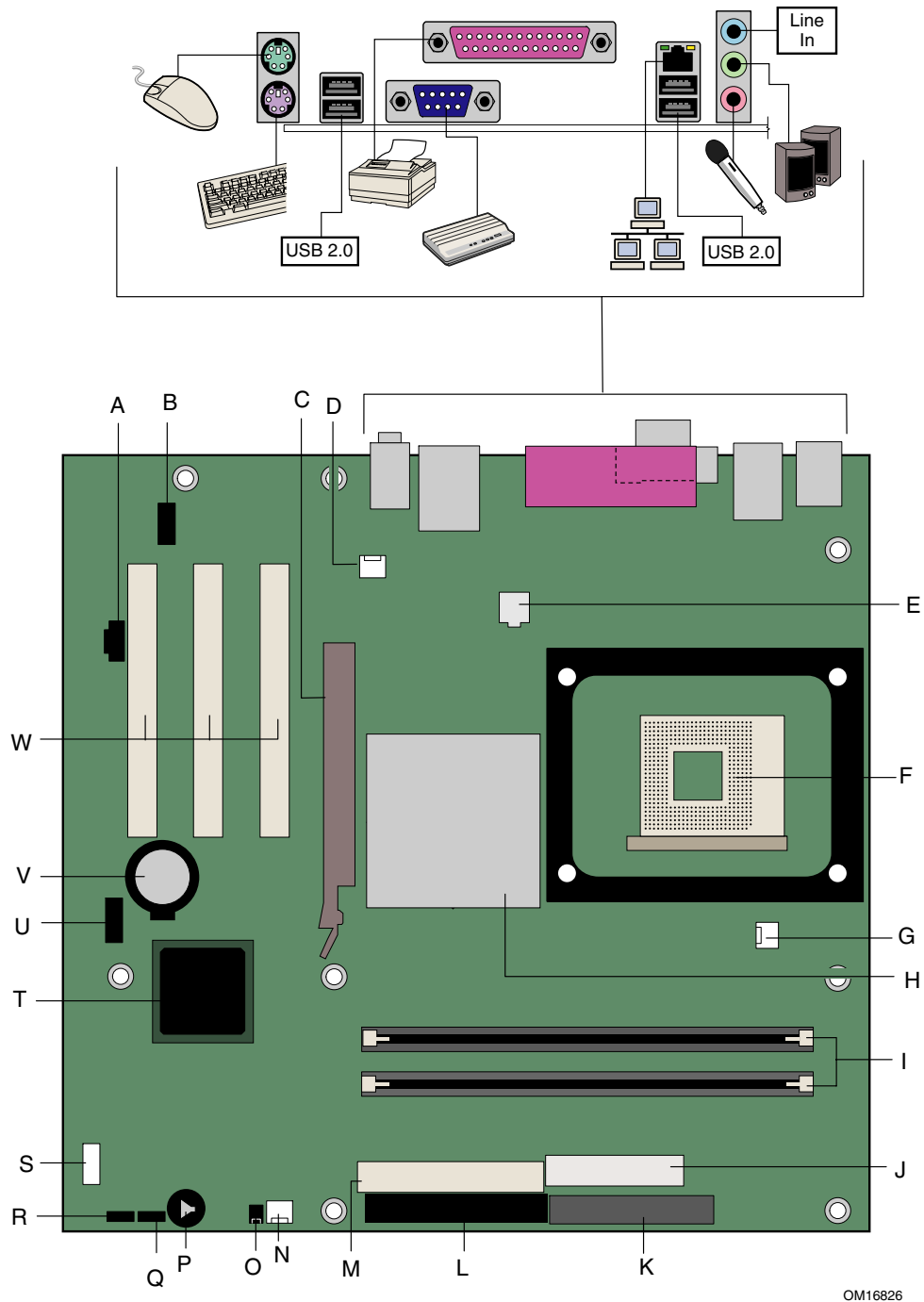

OM16826

Figure 1. Desktop Board D865PCD Components

**Table 2. Desktop Board Components**

| Label | Description                           |
|-------|---------------------------------------|
| A     | CD-ROM audio connector (ATAPI-style)  |
| B     | Front panel audio header              |
| C     | AGP connector                         |
| D     | Rear chassis fan header               |
| E     | 12 V processor core voltage connector |
| F     | Processor socket                      |
| G     | Processor fan header                  |
| H     | Intel 82865P (MCH)                    |
| I     | DIMM sockets                          |
| J     | Main power connector                  |
| K     | Diskette drive connector              |
| L     | Primary IDE connector                 |
| M     | Secondary IDE connector               |
| N     | Front chassis fan header              |
| O     | Chassis intrusion header              |
| P     | Speaker                               |
| Q     | BIOS configuration jumper             |
| R     | Alternate power/sleep LED header      |
| S     | Front panel header                    |
| T     | Intel 82801EB (ICH5)                  |
| U     | USB 2.0 header                        |
| V     | Battery                               |
| W     | PCI bus add-in card connectors        |

### Related Links

Go to the following links for the latest information about:

- Intel Desktop Board D865PCD, <http://www.intel.com/design/motherbd>
- Processors, <http://support.intel.com/support/motherboards/desktop>
- Audio software and utilities, <http://www.intel.com/design/motherbd>
- LAN software and drivers, <http://www.intel.com/design/motherbd>

## Processor



### CAUTION

*Failure to use an ATX12V power supply, or not connecting the 12 V processor core voltage power supply connector to Desktop Board D865PCD may result in damage to the desktop board and/or power supply.*

Desktop Board D865PCD supports a single Intel Pentium 4 processor or Intel Celeron processor. Processors are not included with the desktop board and must be purchased separately.

The processor connects to the Intel desktop board through the mPGA478-pin socket. The Intel® processors may be removed and replaced to accommodate supported higher speed processors. Desktop Board D865PCD supports the processors listed in Table 3.

**Table 3. Supported Processors**

| Type   | Designation (GHz)                               | FSB Frequency (MHz) | L2 Cache (KB) |
|--|---|---------------------|---------------|
| Intel® Pentium® 4 processor (with HT Technology) | 3.06  | 533                 | 512           |
| Intel Pentium 4 processor                        | 2.80A, 2.40A                                    | 533                 | 1024          |
| Intel Pentium 4 processor                        | 2.8, 2.66, 2.53, 2.4B, and 2.26                 | 533                 | 512           |
|  | 2.6, 2.5, 2.40, 2.20, 2A, 1.80A, and 1.60A      | 400                 | 512           |
| Intel® Celeron® processor                        | 2.8, 2.7, 2.6, 2.5, 2.4, 2.3, 2.2, 2.1, and 2.0 | 400                 | 128           |

Desktop Board D865PCD requires an ATX12V compliant power supply to function according to desktop board specifications. The board has two ATX12V compliant power supply connectors that are needed to provide extra power to the Intel 865P chipset and Intel processor.

### Related Links

Go to the following link or sections in this manual for more information about:

- The latest supported Intel processors for Desktop Board D865PCD  
<http://support.intel.com/support/motherboards/desktop/>
- Installing or upgrading the processor, page 28 in Chapter 2
- The location of the ATX12V compliant power supply connectors, page 38

## Main Memory



### NOTE

To be fully compliant with all applicable Intel® SDRAM memory specification addendums, the board should be populated with DIMMs that support the Serial Presence Detect (SPD) data structure. If your memory modules do not support SPD, you will see a notification to this effect on the screen at power up. The BIOS will attempt to configure the memory controller for normal operation.

The desktop board supports system memory as defined below:

- Dual channel and up to four 184-pin Double Data Rate (DDR) SDRAM Dual Inline Memory Module (DIMMs) connectors with gold-plated contacts.
- Supported memory configurations are:

| Memory Speed | Processor                                | Front Side Bus Frequency | Memory Speed Outcome |
|--------------|--|--------------------------|----------------------|
| DDR333       | Pentium 4 processor                      | 533 MHz                  | 333 MHz              |
|              | Pentium 4 processor or Celeron processor | 400 MHz                  | 266 MHz              |
| DDR266       | Pentium 4 processor                      | 533 MHz or 400 MHz       | 266 MHz              |
|              | Celeron processor                        | 400 MHz                  | 266 MHz              |

- Support for:
  - Unbuffered, non-registered DIMMs
  - Serial Presence Detect (SPD) memory only
  - Support for Suspend to RAM (STR), S3 ACPI state
  - Non-ECC DDR
  - 2.5 V memory

### Related Links

Go to the following links or section in this manual for more information about:

- The latest list of tested memory, <http://support.intel.com/support/motherboards/desktop/>
- SDRAM specifications, <http://www.intel.com/technology/memory/pcsdram/spec/>
- Installing memory, page 30 in Chapter 2



## Intel® 865P Chipset

The Intel 865P chipset consists of the following devices:

- Intel 82865P Memory Controller Hub (MCH) with AHA bus
- Intel 82801EB I/O Controller Hub (ICH5) with AHA bus
- Firmware Hub (FWH)

### Related Link

For more information about the Intel 865P chipset, go to:

<http://developer.intel.com/design/nav/pcserver.htm>

## Graphics Subsystem

The graphics subsystem features the following:

- The Intel 865P chipset
- 1.5 V and 0.8 V only AGP connector
- Single AGP port via the connector or integrated graphics
- AGP 3.0 including 1x/4x/8x data transfers and 1x/4x/8x Fast Writes

## Audio Subsystem

The audio subsystem features the following:

- Intel 865P chipset (AC '97)
- Realtek ALC202A audio codec

### Related Links

Go to the following link or sections in this manual for more information about:

- Audio drivers and utilities, <http://support.intel.com/support/motherboards/desktop/>
- Installing the front panel audio solution, page 35 in Chapter 2

## LAN Subsystem

The optional LAN provides a Fast PCI LAN subsystem. The LAN subsystem provides the following functions:

- 10/100 Ethernet LAN (Intel 82502EZ)
- Support for RJ-45 connector with status indicator LEDs
- Programmable transit threshold
- Configurable EEPROM that contains the MAC address

### LAN Subsystem Software

For LAN software and drivers, refer to the D865PCD link on Intel's World Wide Web site at:

<http://support.intel.com/support/motherboards/desktop>

## RJ-45 LAN Connector LEDs

Two LEDs are built into the RJ-45 LAN connector. Table 4 describes the LED states when the board is powered up and the 10/100 Ethernet LAN subsystem is operating.

**Table 4. RJ-45 10/100 Ethernet LAN Connector LEDs**

| LED Color | LED State                 | Indicates   |
|-----------|---------------------------|---|
| Green     | Off                       | 10 Mbit/sec data rate is selected.                              |
|           | On                        | 100 Mbit/sec data rate is selected.                             |
| Yellow    | Off                       | LAN link is not established.                                    |
|           | On (steady state)         | LAN link is established.  |
|           | On (brighter and pulsing) | The computer is communicating with another computer on the LAN. |

## Input/Output (I/O) Controller

The super I/O controller features the following:

- Low pin count (LPC) interface
- One serial port
- One parallel port with Extended Capabilities Port (ECP) and Enhanced Parallel Port (EPP) support
- Serial IRQ interface compatible with serialized IRQ support for PCI systems
- PS/2-style mouse and keyboard interfaces
- Interface for one 1.44 MB or 2.88 MB diskette drive
- Intelligent power management, including a programmable wake up event interface
- PCI power management support

## Hi-Speed USB 2.0 Support



### NOTE

*Computer systems that have an unshielded cable attached to a USB port might not meet FCC Class B requirements, even if no device or a low-speed USB device is attached to the cable. Use a shielded cable that meets the requirements for a full-speed USB device.*

The desktop board supports up to six USB 2.0 ports via ICH5; four ports routed to the back panel and two routed to the internal USB 2.0 headers. USB 2.0 ports are backward compatible with USB 1.1 devices. USB 1.1 devices will function normally at USB 1.1 speeds.

Disabling Hi-Speed USB in the BIOS reverts all USB 2.0 ports to USB 1.1 operation. This may be required to accommodate operating systems that do not support USB 2.0.



### NOTE

*USB devices are limited to USB 1.1 transfer rates prior to operating system and driver initialization.*

## Enhanced IDE Interface

The ICH5's IDE interface handles the exchange of information between the processor and peripheral devices like hard disks, CD-ROM drives, and Iomega Zip\* drives inside the computer. The interface supports:

- Up to four IDE devices (such as hard drives)
- ATAPI-style devices (such as CD-ROM drives)
- Older PIO Mode devices
- Ultra DMA-33 and ATA-66/100 protocols
- Laser Servo (LS-120) drives

## Accelerated Graphics Port (AGP)



### NOTE

*Desktop Board D865PCD is only compatible with 0.8 V and 1.5 V AGP cards.*

*The AGP connector is keyed for 0.8 V and 1.5 V AGP cards only; the connector is not mechanically compatible with legacy 3.3 V AGP cards. Do not attempt to install a legacy 3.3 V AGP card.*

AGP is a high-performance interface for graphics-intensive applications, such as 3D graphics. AGP is independent of the PCI bus and is intended for exclusive use with graphical display devices.

The AGP 3.0 connector supports 8x, 4x, and 1x AGP cards.

### Related Links

For information about installing the AGP card, see page 32 in Chapter 2.

## BIOS

The BIOS provides the Power-On Self-Test (POST), the BIOS Setup program, the PCI and IDE auto-configuration utilities, and the video BIOS. The BIOS is stored in the Firmware Hub.

The BIOS can be updated by following the instructions in Chapter 3 on page 47.

### PCI Auto Configuration

If you install a PCI add-in card in your computer, the PCI auto-configuration utility in the BIOS automatically detects and configures the resources (IRQs, DMA channels, and I/O space) for that add-in card. You do not need to run the BIOS Setup program after you install a PCI add-in card.

### IDE Auto Configuration

If you install an IDE device (such as a hard drive) in your computer, the IDE auto-configuration utility in the BIOS automatically detects and configures the device for your computer. You do not need to run the BIOS Setup program after installing an IDE device. You can override the auto-configuration options by specifying manual configuration in the BIOS Setup program.

To use ATA-66/100 features, the following items are required:

- An ATA-66/100 peripheral device
- An ATA-66/100 compatible cable
- ATA-66/100 operating system device drivers

## Security Passwords

The BIOS includes security features that restrict whether the BIOS Setup program can be accessed and who can boot the computer. A supervisor password and a user password can be set for the Setup and for booting the computer, with the following restrictions:

- The supervisor password gives unrestricted access to view and change all Setup options. If only the supervisor password is set, pressing <Enter> at the password prompt of Setup gives the user restricted access to Setup.
- If both the supervisor and user passwords are set, you must enter either the supervisor password or the user password to access Setup. Setup options are then available for viewing and changing depending on whether the supervisor or user password was entered.
- Setting a user password restricts who can boot the computer. The password prompt is displayed before the computer is booted. If only the supervisor password is set, the computer boots without asking for a password. If both passwords are set, you can enter either password to boot the computer.

## Chassis Intrusion

The board supports a chassis security feature that detects if the chassis cover has been removed. The security feature uses a mechanical switch on the chassis that can be connected to the chassis intrusion header on the desktop board. See Figure 10 on page 37 for the location of the chassis intrusion header.

## Power Management Features

Power management is implemented at several levels, including:

- Advanced Configuration and Power Interface (ACPI)
- Hardware support:
  - Power connectors
  - Fan connectors
  - Suspend to RAM (Instantly Available PC technology)
  - Resume on Ring
  - Wake from USB
  - Wake from PS/2 keyboard/mouse
  - PME# wakeup support

### ACPI

ACPI gives the operating system direct control over the power management and Plug & Play functions of a computer. The use of ACPI with the desktop board requires an operating system that provides full ACPI support.

### Power Connectors

The desktop board has two power connectors. See Figure 10 on page 37 for the location of the power connectors.

## Fan Connectors

The desktop board has two chassis fan connectors (Intel Precision Cooling Technology) and one processor fan connector. See Figure 10 on page 37 for the location of the fan connectors.

## Suspend to RAM (Instantly Available PC Technology)



### CAUTION

*For Instantly Available PC technology, the 5 V standby line for the power supply must be capable of delivering adequate +5 V standby current. Failure to provide adequate standby current when using this feature can damage the power supply and/or effect ACPI S3 sleep state functionality.*

Instantly Available PC technology enables the board to enter the ACPI S3 (Suspend-to-RAM) sleep state. While in the S3 sleep state, the computer will appear to be off. When signaled by a wake-up device or event, the system quickly returns to its last known awake state.

If the system has a dual-colored power LED on the front panel, the sleep state is indicated by the LED turning amber.



### CAUTION

*Power supplies used with this desktop board must be able to provide enough standby current to support the standard Instantly Available (ACPI S3 sleep state) configuration. If the standby current necessary to support multiple wake events from the PCI and/or USB buses exceeds power supply capacity, the desktop board may lose register settings stored in memory.*

## Related Link

For more information about standby current requirements for these desktop boards, refer to the TPS by selecting the Technical Documentation link at:

<http://developer.intel.com/design/motherbd/>

## Resume on Ring

The operation of Resume on Ring can be summarized as follows:

- Resumes operation from either ACPI S1 or ACPI S3 state
- Requires only one call to access the computer
- Detects incoming call similarly for external and internal modems
- Requires modem interrupt be unmasked for correct operation

## Wake from USB

USB bus activity wakes the computer from an ACPI S1 or S3 state.



### NOTE

*Wake from USB requires the use of a USB peripheral that supports Wake from USB.*

## Wake from PS/2 Keyboard/Mouse

PS/2 keyboard/mouse activity wakes the computer from an ACPI S1 or S3 state.

## PME# Wakeup Support

When the PME# signal on the PCI bus is asserted, the computer wakes from an ACPI S1, S3, or S5 state.

## Speaker

A speaker is mounted on the desktop board. The speaker provides audible error code (beep code) information during the Power-On Self-Test (POST). For a list of the beep codes, see Table 37 on page 81.

## Battery

The battery on the desktop board keeps the values in CMOS RAM and the clock current when the computer is turned off. See page 43 in Chapter 2 for instructions on how to replace the battery.

## Real-Time Clock

The desktop board has a time-of-day clock and 100-year calendar. The battery on the desktop board keeps the clock current when the computer is turned off.

## 2 Installing and Replacing Desktop Board Components

---

This chapter tells you how to:

- Install the I/O shield
- Install and remove the desktop board
- Install and remove a processor and memory
- Install and remove an AGP card
- Connect the IDE cable
- Connect internal headers
- Connect hardware control and power cables
- Locate the add-in card and peripheral interface connectors
- Set the BIOS configuration jumper
- Clear passwords
- Identify back panel connectors
- Replace the battery

### Before You Begin



#### WARNINGS

*The procedures in this chapter assume familiarity with the general terminology associated with personal computers and with the safety practices and regulatory compliance required for using and modifying electronic equipment.*

*Disconnect the computer from its power source and from any telecommunications links, networks, or modems before performing any of the procedures described in this chapter. Failure to disconnect power, telecommunications links, networks, or modems before you open the computer or perform any procedures can result in personal injury or equipment damage. Some circuitry on the board can continue to operate even though the front panel power button is off.*



#### CAUTION

*Many of the internal and front panel connectors provide operating voltage (+5 V dc and +12 V dc, for example) to devices inside the computer chassis, such as fans and internal peripherals. These connectors are not overcurrent protected. Do not use these connectors for powering devices external to the computer chassis. A fault in the load presented by the external devices could cause damage to the computer, the interconnecting cable, and the external devices themselves.*

Follow these guidelines before you begin:

- Always follow the steps in each procedure in the correct order.
- Set up a log to record information about your computer, such as model, serial numbers, installed options, and configuration information.
- Electrostatic discharge (ESD) can damage components. Perform the procedures described in this chapter only at an ESD workstation using an antistatic wrist strap and a conductive foam pad. If such a station is not available, you can provide some ESD protection by wearing an antistatic wrist strap and attaching it to a metal part of the computer chassis.

## Installation Precautions

When you install and test the Intel desktop board, observe all warnings and cautions in the installation instructions.

To avoid injury, be careful of:

- Sharp pins on connectors
- Sharp pins on printed circuit assemblies
- Rough edges and sharp corners on the chassis
- Hot components (like processors, voltage regulators, and heat sinks)
- Damage to wires that could cause a short circuit

Observe all warnings and cautions that instruct you to refer computer servicing to qualified technical personnel.

## Installation Instructions



### CAUTION

*Follow these guidelines to meet safety and regulatory requirements when installing this board assembly.*

Read and adhere to all of these instructions and the instructions supplied with the chassis and associated modules. If the instructions for the chassis are inconsistent with these instructions or the instructions for associated modules, contact the supplier's technical support to find out how you can ensure that your computer meets safety and regulatory requirements. If you do not follow these instructions and the instructions provided by chassis and module suppliers, you increase safety risk and the possibility of noncompliance with regional laws and regulations.

### Ensure Electromagnetic Compatibility (EMC) Compliance

Before computer integration, make sure that the power supply and other modules or peripherals, as applicable, have passed Class B EMC testing and are marked accordingly.

In the installation instructions for the host chassis, power supply, and other modules pay close attention to the following:

- Product certifications or lack of certifications
- External I/O cable shielding and filtering
- Mounting, grounding, and bonding requirements
- Keying connectors when mating the wrong connectors could be hazardous



If the power supply and other modules or peripherals, as applicable, are not Class B EMC compliant before integration, then EMC testing is required on a representative sample of the newly completed computer.

### Chassis and Component Certifications

Ensure that the chassis and certain components; such as the power supply, peripheral drives, wiring, and cables; are components certified for the country or market where used. Agency certification marks on the product are proof of certification. Typical product certifications include:

- **In Europe**

The CE marking signifies compliance with all applicable European requirements. If the chassis and other components are not properly CE marked, a supplier's Declaration of Conformity statement to the European EMC directive and Low Voltage directive (as applicable), should be obtained. Additionally, other directives, such as the Radio and Telecommunications Terminal Equipment (R&TTE) directive may also apply depending on product features.

- **In the United States**

A certification mark by a Nationally Recognized Testing Laboratory (NRTL) such as UL, CSA, or ETL signifies compliance with safety requirements. Wiring and cables must also be UL listed or recognized and suitable for the intended use. The FCC Class B logo for home or office use signifies compliance with electromagnetic interference (EMI) requirements.

- **In Canada**

A nationally recognized certification mark such as CSA or cUL signifies compliance with safety requirements. The Industry Canada statement at the front of this product guide demonstrates compliance with Canadian EMC regulations. Industry Canada recognizes and accepts FCC certification as denoting compliance with national electromagnetic interference (emissions) requirements.

### Prevent Power Supply Overload

Do not overload the power supply output. To avoid overloading the power supply, make sure that the calculated total current loads of all the modules within the computer is less than the output current rating of each of the power supplies output circuits.

### Place Battery Marking

There is insufficient space on this desktop board to provide instructions for replacing and disposing of the Lithium ion coin cell battery. For system safety certification, the following statement or equivalent statement is required to be permanently and legibly marked on the chassis near the battery.



#### **CAUTION**

*Risk of explosion if the battery is replaced with an incorrect type. Batteries should be recycled where possible. Disposal of used batteries must be in accordance with local environmental regulations.*

## Use Only for Intended Applications

All Intel desktop boards are evaluated as Information Technology Equipment (I.T.E.) for use in personal computers for installation in homes, offices, schools, computer rooms, and similar locations. The suitability of this product for other applications or environments, such as medical, industrial, alarm systems, test equipment, etc. may require further evaluation.

### Related Links

For information about regulatory compliance, go to Appendix B on page 85.

## Installing the I/O Shield

The desktop board comes with an I/O shield. When installed in the chassis, the shield blocks radio frequency transmissions, protects internal components from dust and foreign objects, and promotes correct airflow within the chassis.

Install the I/O shield before installing the desktop board in the chassis. Place the shield inside the chassis as shown in Figure 2. Press the shield into place so that it fits tightly and securely. If the shield doesn't fit, obtain a properly-sized shield from the chassis supplier.

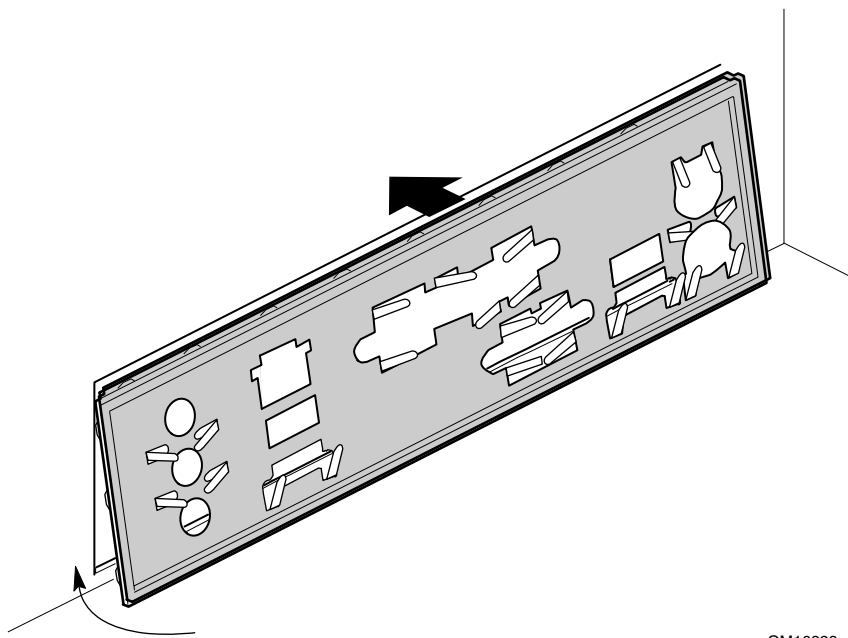

OM16828

Figure 2. Installing the I/O Shield

## Installing and Removing the Desktop Board

### WARNING

*Only qualified technical personnel should do this procedure. Disconnect the computer from its power source before performing the procedures described here. Failure to disconnect the power before you open the computer can result in personal injury or equipment damage.*



### NOTE

*Refer to Appendix B for regulatory requirements.*

Refer to your chassis manual for instructions on installing and removing the desktop board.

Figure 3 shows the location of the eight mounting screw holes for Desktop Board D865PCD.

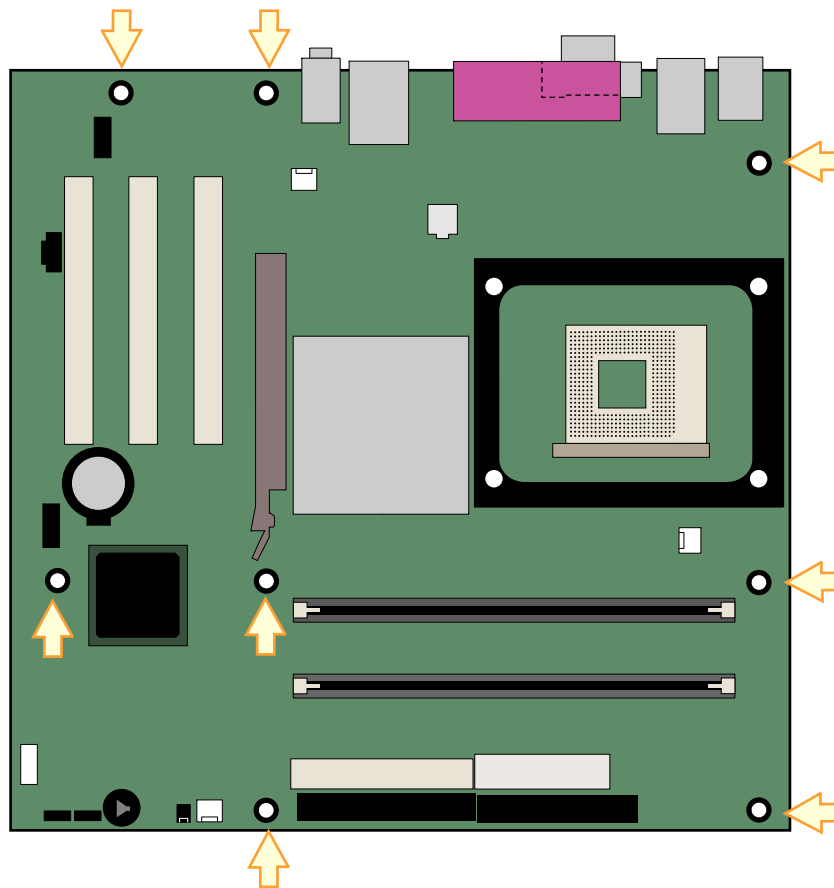

OM16829

**Figure 3. Location of Mounting Screw Holes**

## Installing and Removing a Processor

Instructions on how to install the processor to the desktop board are given below.

### Installing a Processor



#### CAUTION

*Before installing or removing the processor, make sure that AC power has been removed by unplugging the power cord from the computer. Failure to do so could damage the processor and the board.*

To install a processor, follow these instructions:

1. Observe the precautions in “Before You Begin” on page 23.
2. Locate the processor socket and raise the socket lever completely.
3. Install the processor so that the corner with the triangle marking (A) is aligned with the corner where the lever is attached to the socket (see Figure 4).
4. Lower the lever to its original position.

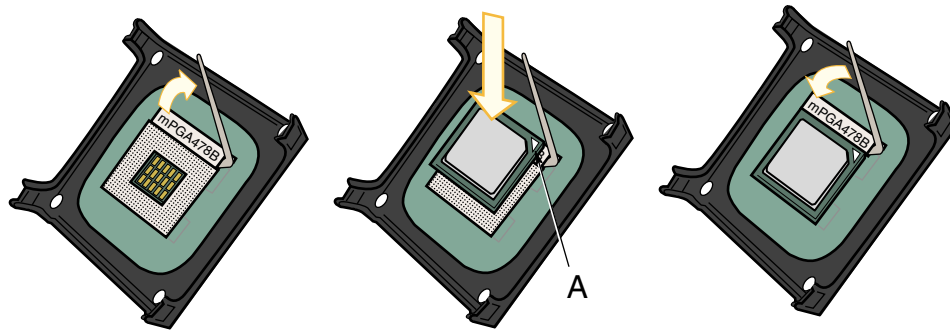

OM15028

Figure 4. Installing a Processor

### Installing the Processor Fan Heat Sink

Desktop Board D865PCD has an integrated processor fan heat sink retention mechanism (RM). For instructions on how to install the processor fan heat sink to the integrated processor fan heat sink RM, refer to the boxed processor manual or the Intel World Wide Web site at:

<http://support.intel.com/support/processors/pentium4/intnotes478.htm>

## Connecting the Processor Fan Heat Sink Cable

Connect the processor fan heat sink cable to the processor fan connector (see Figure 5).

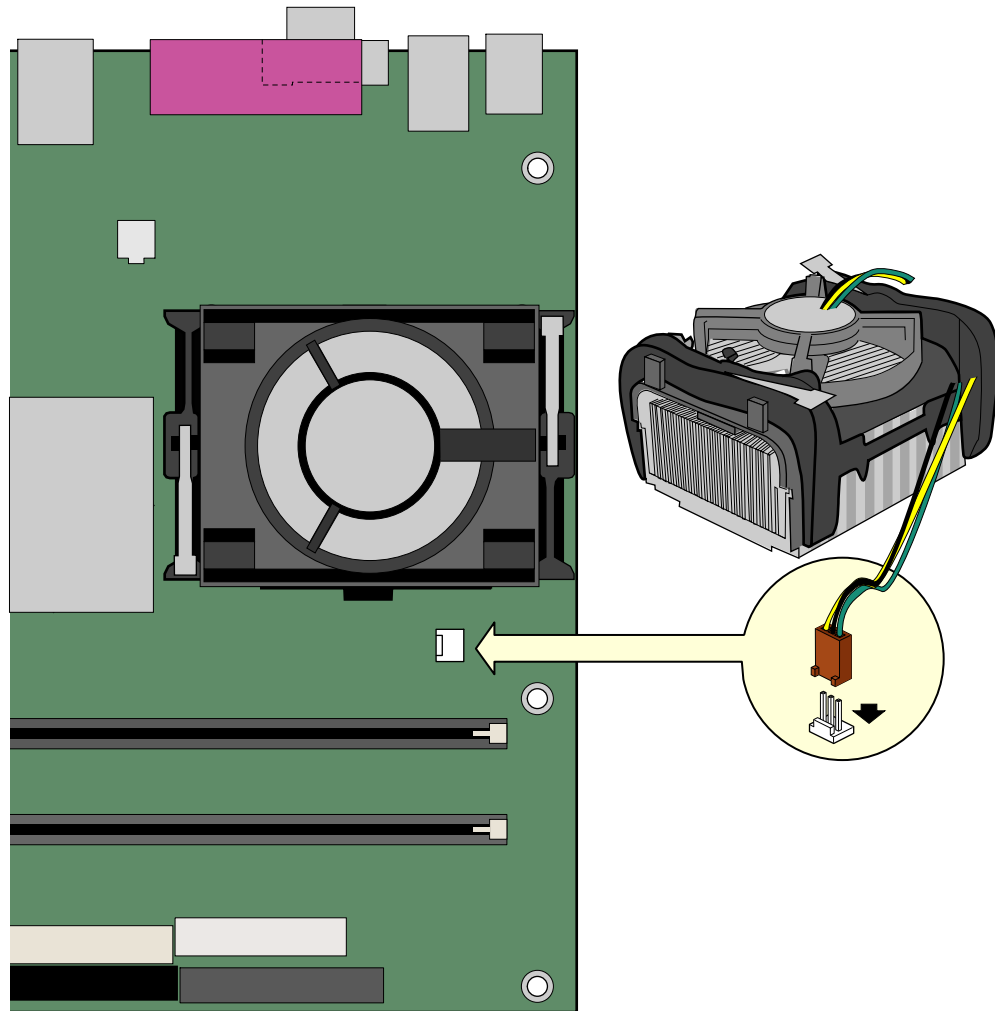

OM16830

**Figure 5. Connecting the Processor Fan Heat Sink Cable to the Processor Fan Connector**

## Removing the Processor

For instruction on how to remove the processor fan heat sink and processor, refer to the processor installation manual or the Intel World Wide Web site at:

<http://support.intel.com/support/processors/pentium4/intnotes478.htm>

## Installing and Removing Memory



### CAUTION

To be fully compliant with all applicable Intel SDRAM memory specification addendums, the board requires DIMMs that support the Serial Presence Detect (SPD) data structure. You can access the PC Serial Presence Detect Specification at:

<http://www.intel.com/technology/memory/pcsdram/spec/>

Desktop Board D865PCD has two 184-pin DIMM sockets arranged as Channel A and Channel B, as shown in Figure 6.

Refer to the “Main Memory” section on page 16 for memory requirements.

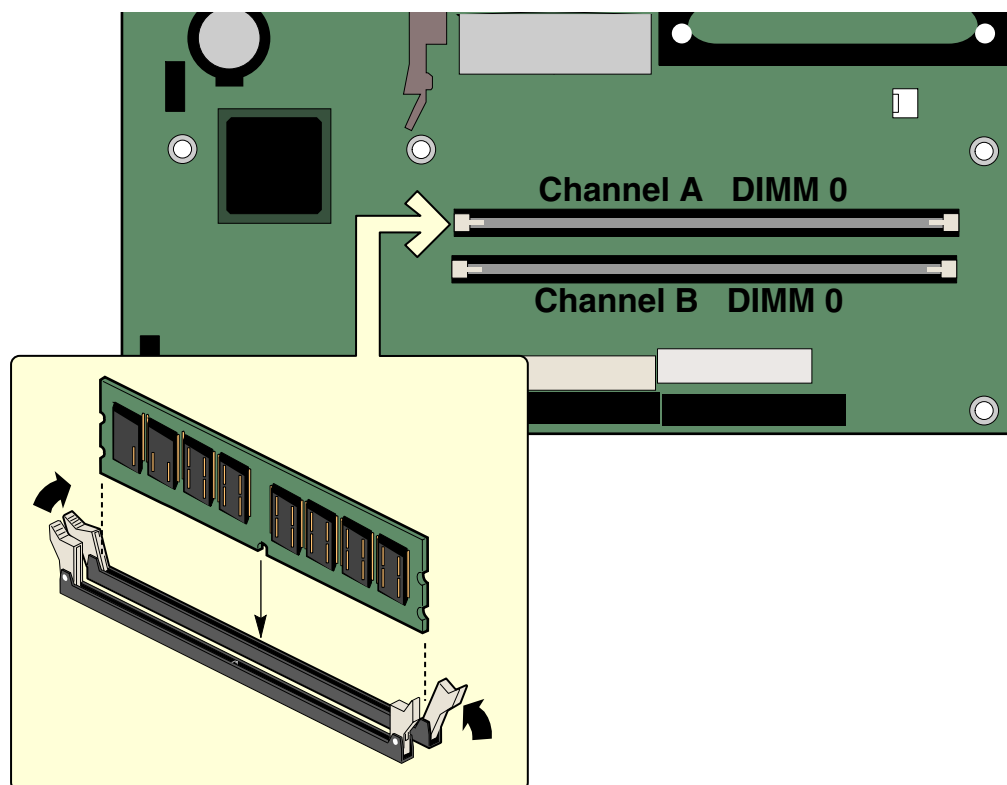

OM16831

Figure 6. Installing a Memory Module

## Installing DIMMs



### CAUTION

*Install memory in the DIMM sockets prior to installing an AGP video card to avoid interference with the memory retention mechanism.*

To install DIMMs, follow these steps:

1. Observe the precautions in “Before You Begin” on page 23.
2. Turn off all peripheral devices connected to the computer. Turn off the computer and disconnect the AC power cord.
3. Remove the computer’s cover and locate the DIMM sockets (see Figure 6).
4. Remove the AGP video card if it interferes with the DIMM clips from being easily opened and closed.
5. Make sure the clips at either end of the DIMM socket(s) are pushed outward to the open position.
6. Holding the DIMM by the edges, remove it from its anti-static package.
7. Position the DIMM above the socket. Align the small notch in the bottom edge of the DIMM with the key in the socket (see inset in Figure 6).
8. Insert the bottom edge of the DIMM into the socket.
9. When the DIMM is inserted, push down on the top edge of the DIMM until the retaining clips snap into place. Make sure the clips are firmly in place.
10. Reinstall the AGP card if it was removed prior to installing the DIMMs.
11. Replace the computer’s cover and reconnect the AC power cord.

## Removing DIMMs

To remove a memory module, follow these steps:

1. Observe the precautions in “Before You Begin” on page 23.
2. Turn off all peripheral devices connected to the computer. Turn off the computer.
3. Remove the AC power cord from the computer.
4. Remove the computer’s cover.
5. Remove the AGP card if it interferes with the DIMM clips from being easily opened and closed.
6. Gently open the retaining clips at each end of the DIMM socket. The DIMM pops out of the socket.
7. Hold the DIMM by the edges, lift it away from the socket, and store it in an anti-static package.
8. Reinstall the AGP card if you removed it before taking out the DIMMs.
9. Reinstall and reconnect any parts you removed or disconnected to reach the DIMM sockets.
10. Replace the computer’s cover and reconnect the AC power cord.

## Installing and Removing an AGP Card



### CAUTION

When installing any AGP card in the desktop board, ensure that it is fully seated in the AGP connector before you power on the system. If the card is not fully seated in the AGP connector, an electrical short may result across the AGP connector pins. Depending on the over-current protection of the power supply, certain board components and/or traces may be damaged.

The AGP connector supports 0.8 V (4x and 1x) and 1.5 V (8x) AGP cards. The desktop board has an integrated AGP card retention mechanism (RM).

### Installing an AGP Card

Follow these instructions to install an AGP card:

1. Observe the precautions in “Before You Begin” on page 23.
2. Place the card in the AGP connector.
3. Press down on the card until it is completely seated in the AGP connector and the card retention notch snaps into place around the RM pin.
4. Secure the card’s metal bracket to the chassis back panel with a screw.

### Removing the AGP Card

Follow these instructions to remove the AGP card from the RM (see Figure 7):

1. Observe the precautions in “Before You Begin” on page 23.
2. Remove the screw (B) that secures the card’s metal bracket (A) to the chassis back panel.
3. Push back on the RM lever (C), as shown in Figure 7, until the retention pin completely clears the notch in the card.
4. Pull the card straight up (D).

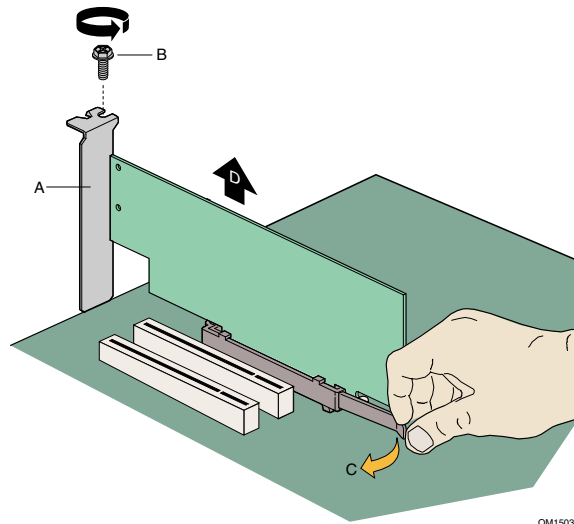

Figure 7. Removing the AGP Card



## Connecting the IDE Cable

The two IDE cables support the Ultra DMA-33 and ATA-66/100 transfer protocols. Each of the cables can connect two drives to the desktop board. Figure 8 shows the correct installation of the cable.



### NOTE

*ATA-66/100 compatible cables are backward compatible with drives using slower IDE transfer protocols. If an ATA-66/100 disk drive and a disk drive using any other IDE transfer protocol are attached to the same cable, the maximum transfer rate between the drives may be reduced to that of the slowest drive.*



### NOTE

*Do not connect an ATA device as a slave on the same IDE cable as an ATAPI master device. For example, do not connect an ATA hard drive as a slave to an ATAPI CD-ROM drive.*

For correct function of the cable:

- Observe the precautions in “Before You Begin” on page 23.
- Attach the cable end with the single connector to the Intel desktop board (A).
- Attach the cable end with the two closely spaced connectors to the drives (B).

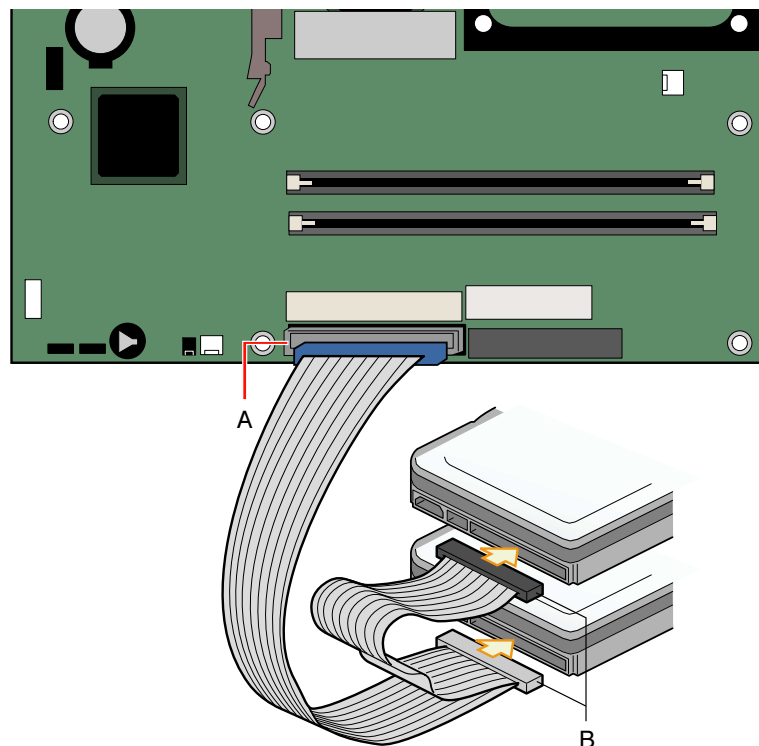

OM16832

**Figure 8. Connecting the IDE Cable**

## Connecting Internal Headers

Figure 9 shows the location of internal headers.

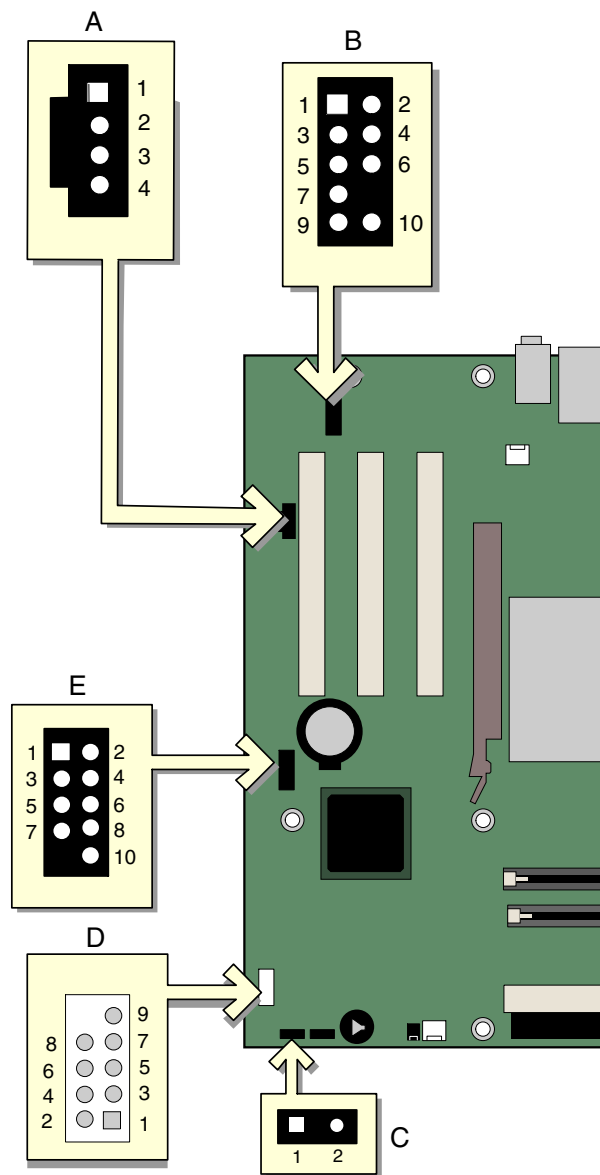

OM16834

| Item | Description               |
|------|---------------------------|
| A    | CD-ROM audio              |
| B    | Front panel audio         |
| C    | Alternate power/sleep LED |
| D    | Front panel               |
| E    | USB 2.0                   |

**Figure 9. Internal Headers**

## Connecting the Front Panel Header

Before connecting the front panel header, observe the precautions in “Before You Begin” on page 23. Figure 9-D on page 34 shows the location of the front panel header. Table 5 shows the pin assignments for the front panel header.

**Table 5. Front Panel Header**

| Pin                            | Signal    | In/Out | Description                                   | Pin                  | Signal       | In/Out | Description            |
|--------------------------------|-----------|--------|---|----------------------|--------------|--------|------------------------|
| <b>Hard Drive Activity LED</b> |           |        |   | <b>Power LED</b>     |              |        |                        |
| 1                              | HD_PWR    | Out    | Hard disk LED pull-up (330 $\Omega$ ) to +5 V | 2                    | HDR_BLNK_GRN | Out    | Front panel green LED  |
| 3                              | HDA#      | Out    | Hard disk active LED                          | 4                    | HDR_BLNK_YEL | Out    | Front panel yellow LED |
| <b>Reset Switch</b>            |           |        |   | <b>On/Off Switch</b> |              |        |                        |
| 5                              | Ground    |        | Ground  | 6                    | SWITCH_ON#   | In     | Power switch           |
| 7                              | FP_RESET# | In     | Reset switch                                  | 8                    | Ground       |        | Ground                 |
| 9                              | +5 V      | Out    | Power   | 10                   | N/C          |        | Not connected          |

## Connecting the USB 2.0 Header

Before connecting the USB 2.0 header, observe the precautions in “Before You Begin” on page 23. Figure 9-E on page 34 shows the location of the USB 2.0 header. Table 6 shows the pin assignments for the header.

**Table 6. USB 2.0 Header**

| <b>USB Port A</b> |              | <b>USB Port B</b> |               |
|-------------------|--------------|-------------------|---------------|
| Pin               | Signal Name  | Pin               | Signal Name   |
| 1                 | Power        | 2                 | Power         |
| 3                 | D-           | 4                 | D-            |
| 5                 | D+           | 6                 | D+            |
| 7                 | Ground       | 8                 | Ground        |
| 9                 | Key (no pin) | 10                | Not connected |

Note: USB ports may be assigned as needed.

## Installing a Front Panel Audio Solution

Figure 9-B shows the location of the front panel audio header. Table 7 shows the pin assignments for the front panel audio header.

**Table 7. Front Panel Audio Header Signal Names**

| Pin | Signal Name  | Pin | Signal Name |
|-----|--------------|-----|-------------|
| 1   | AUD-MIC      | 2   | AUD-GND     |
| 3   | AUD-MIC-BIAS | 4   | AUD-VCC     |
| 5   | AUD-FPOUT-R  | 6   | AUD-RET-R   |
| 7   | HP-ON        | 8   | KEY         |
| 9   | AUD-FPOUT-L  | 10  | AUD-RET-L   |

To install the cable that connects the front panel audio solution to the front panel audio header, follow these steps:

1. Observe the precautions in “Before You Begin” on page 23.
2. Turn off all peripheral devices connected to the computer. Turn off the computer and disconnect the AC power cord.
3. Remove the cover.
4. Locate the front panel audio header. Remove the two jumpers from the header to disable the back panel audio connectors.
5. Install a correctly keyed and shielded front panel audio cable.
6. Connect the audio cable to the front panel audio solution.
7. Replace the cover.

To restore back panel operations, follow these steps:

1. Observe the precautions in “Before You Begin” on page 23.
2. Turn off all peripheral devices connected to the computer. Turn off the computer and disconnect the AC power cord.
3. Remove the cover.
4. Remove the front panel audio cable.
5. Install a jumper on pins 5-6 (rear R channel).
6. Install a jumper on pins 9-10 (rear L channel).
7. Replace the cover.

## Connecting Hardware Control and Power Cables

Figure 10 shows the location of the chassis intrusion and fan headers, and power connectors.

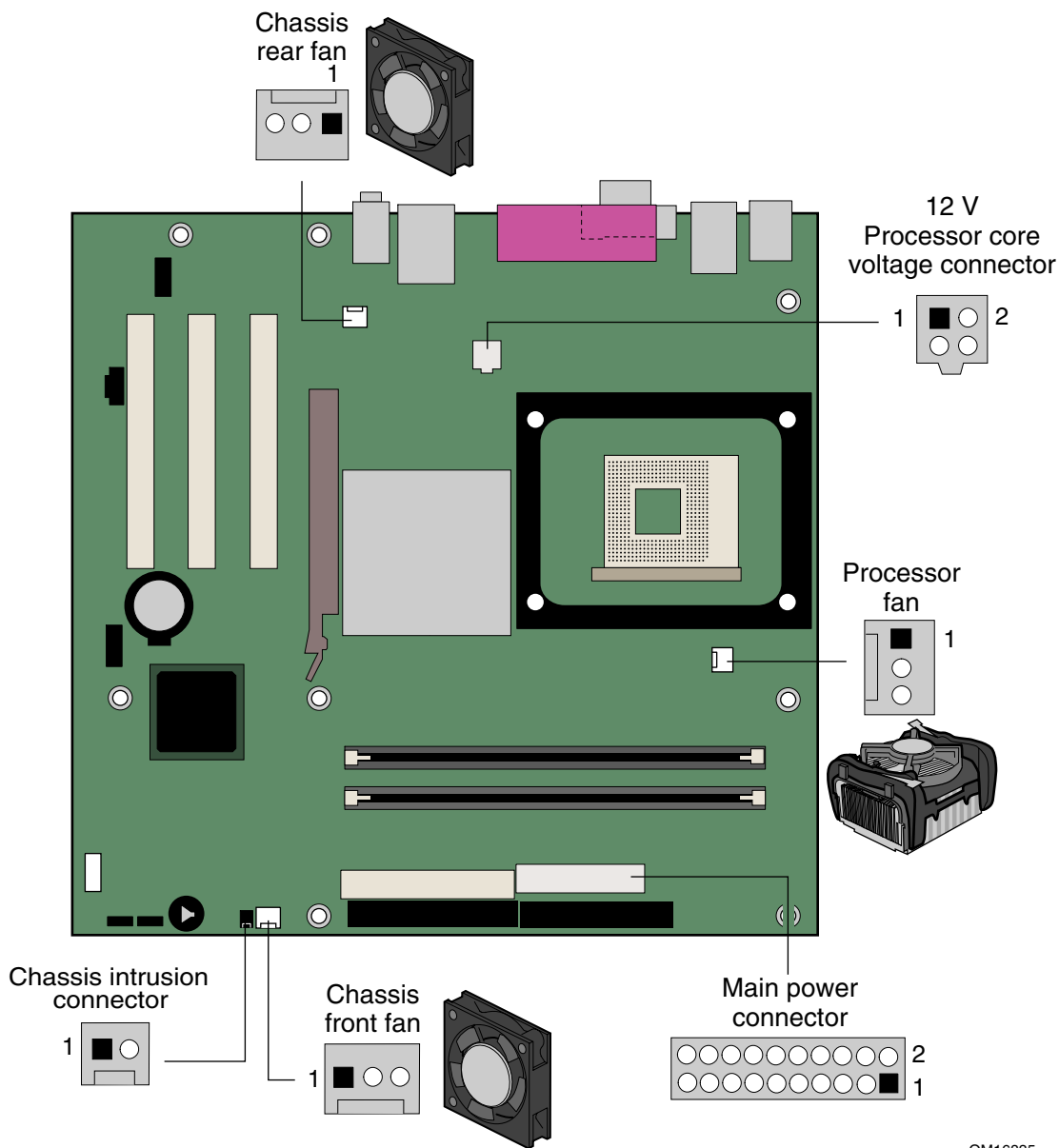

OM16835

**Figure 10. Location of Hardware Control Headers and Power Connectors**

## Connecting the Chassis Intrusion Cable

Connect the chassis intrusion cable to the header shown in Figure 10.

## Connecting Fans

Connect the processor's fan heat sink cable to the processor fan header on the board. Connect chassis fan cables to the board fan headers. See Figure 10 for fan header locations.

## Connecting Power Supply Cables



### CAUTION

*Failure to use an ATX12V power supply, or not connecting the 12 V processor core voltage power supply connector to the desktop board may result in damage to the desktop board and/or power supply.*

Figure 10 shows the location of power connectors.

1. Observe the precautions in “Before You Begin” on page 23.
2. Connect the 12 V processor core voltage power supply cable to the 2x2 connector.
3. Connect the main power cable to the 2x10 connector.

## Add-In Card and Peripheral Interface Connectors

Figure 11 shows the PCI bus add-in card and peripheral interface connectors for Desktop Board D865PCD.

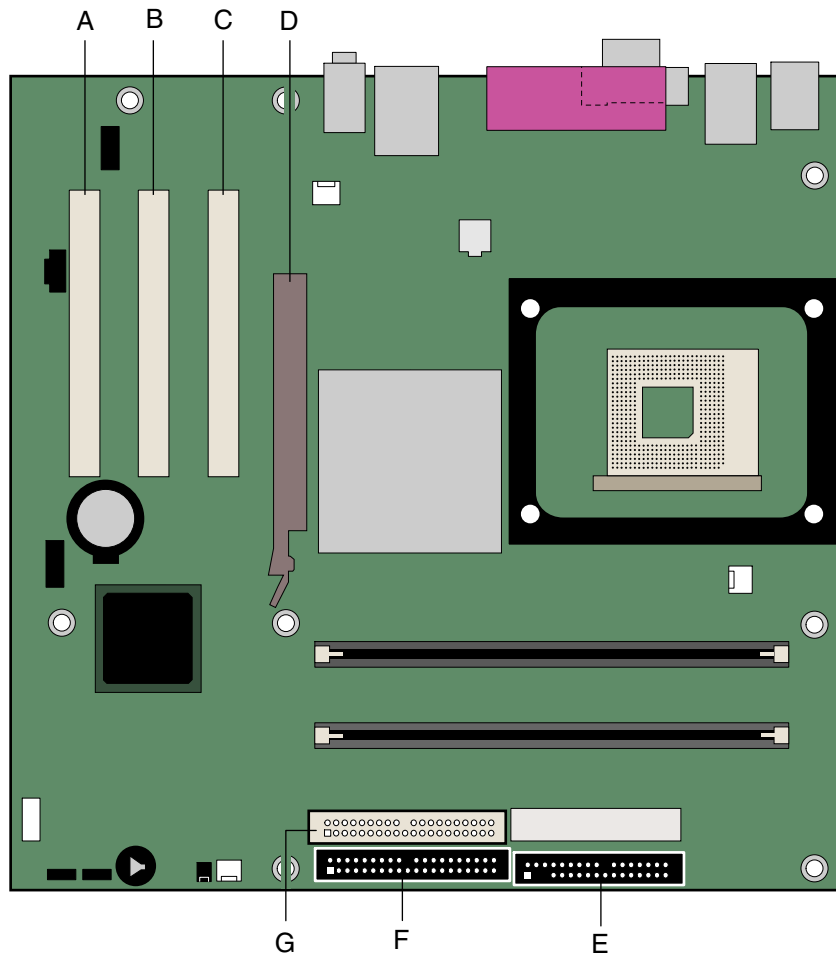

OM16836

| Item | Description                                    | Item | Description   |
|------|--|------|---------------|
| A    | PCI bus add-in card connector 3                | E    | Floppy drive  |
| B    | PCI bus add-in card connector 2 (SMBus routed) | F    | Primary IDE   |
| C    | PCI bus add-in card connector 1                | G    | Secondary IDE |
| D    | AGP  |      |               |

**Figure 11. PCI Bus Add-in Card and Peripheral Interface Connectors**

## Setting the BIOS Configuration Jumper Block

**⚠ CAUTION**

Always turn off the power and unplug the power cord from the computer before changing the jumper. Moving the jumper with the power on may result in unreliable computer operation.

The location of the desktop board's BIOS configuration jumper is shown in Figure 12.

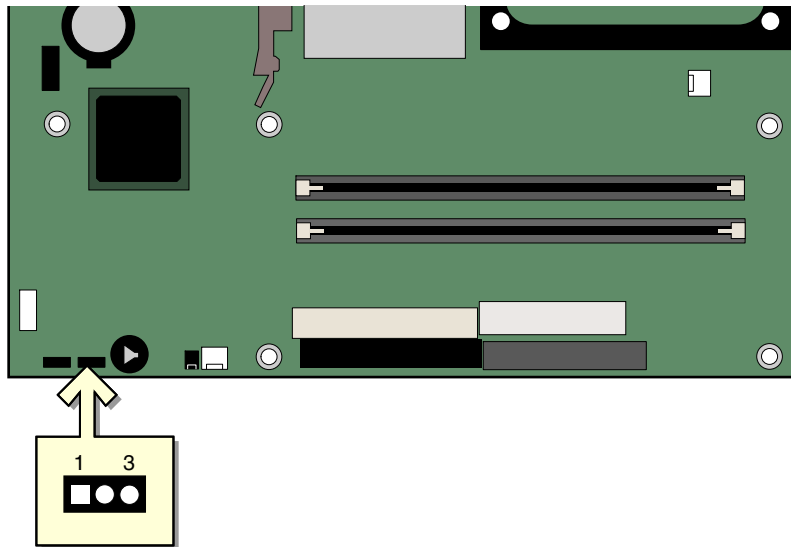



OM16837

**Figure 12. Location of the BIOS Configuration Jumper Block**

The three-pin BIOS jumper block enables all board configurations to be done in BIOS Setup. Table 8 shows the jumper settings for the Setup program modes.

**Table 8. Jumper Settings for the BIOS Setup Program Modes**

| Jumper Setting  | Mode                   | Description   |
|---|------------------------|---|
|  | Normal (default) (1-2) | The BIOS uses the current configuration and passwords for booting.  |
|  | Configure (2-3)        | After the Power-On Self-Test (POST) runs, the BIOS displays the Maintenance Menu. Use this menu to clear passwords. |
|  | Recovery (None)        | The BIOS recovers data from a recovery diskette in the event of a failed BIOS update.                               |



## Clearing BIOS Passwords

This procedure assumes that the board is installed in the computer and the BIOS configuration jumper block is set to normal mode.

1. Observe the precautions in “Before You Begin” on page 23.
2. Turn off all peripheral devices connected to the computer. Turn off the computer. Disconnect the computer’s power cord from the AC power source (wall outlet or power adapter).
3. Remove the computer cover.
4. Find the BIOS configuration jumper block (see Figure 12).
5. Place the jumper on pins 2-3 as shown below.



6. Replace the cover, plug in the computer, turn on the computer, and allow it to boot.
7. The computer starts the Setup program. Setup displays the Maintenance menu.
8. Use the arrow keys to select Clear Passwords. Press <Enter> and Setup displays a pop-up screen requesting that you confirm clearing the password. Select Yes and press <Enter>. Setup displays the maintenance menu again.
9. Press <F10> to save the current values and exit Setup.
10. Turn off the computer. Disconnect the computer’s power cord from the AC power source.
11. Remove the computer cover.
12. To restore normal operation, place the jumper on pins 1-2 as shown below.



13. Replace the cover, plug in the computer, and turn on the computer.

## Back Panel Connectors



### NOTE

The line out connector, located on the back panel, is designed to power either headphones or amplified speakers only. Poor audio quality may occur if passive (non-amplified) speakers are connected to this output.

Figure 13 shows the back panel connectors.

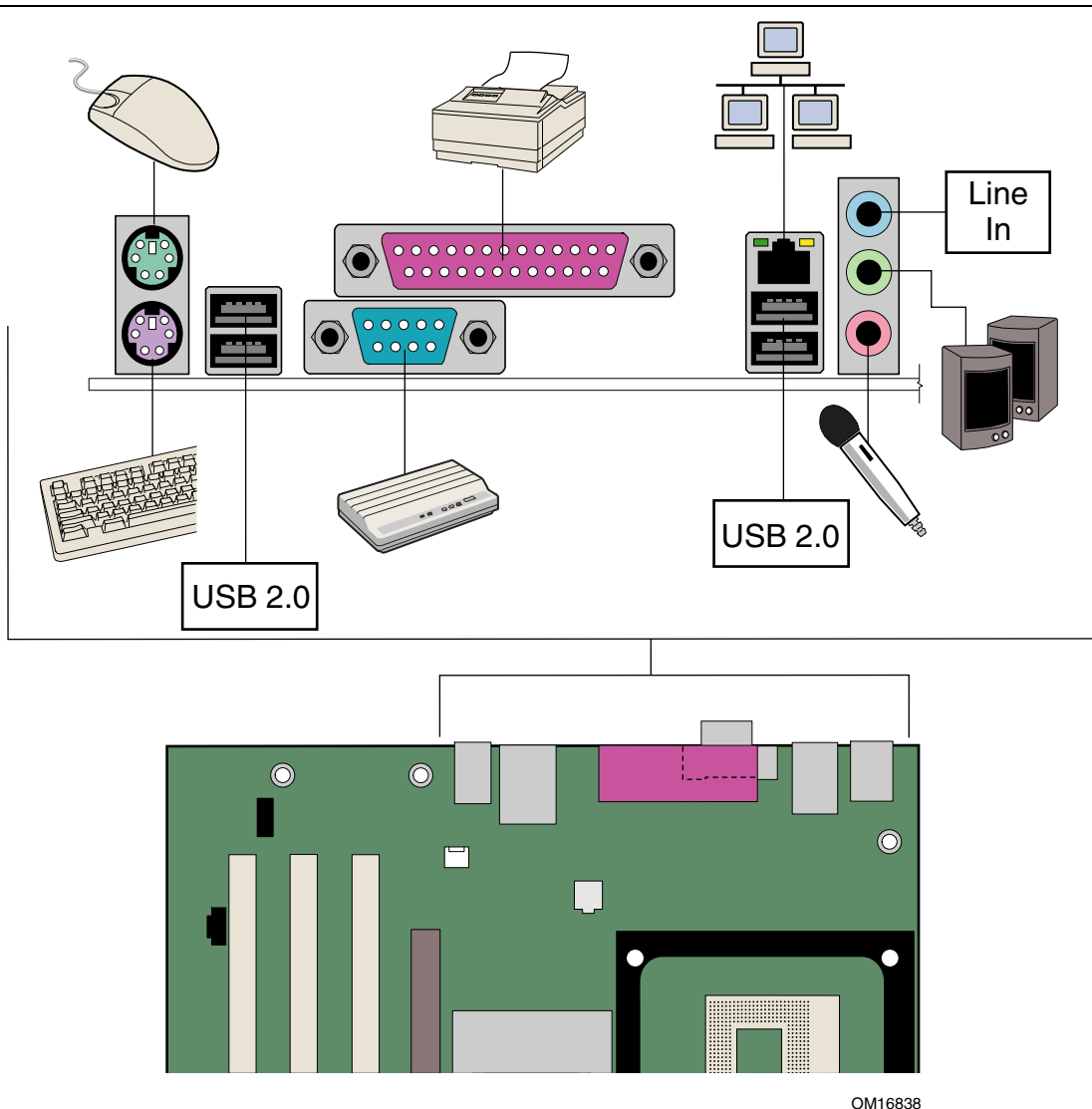

Figure 13. Back Panel Connectors

## Replacing the Battery

A coin-cell battery (CR2032) powers the real-time clock and CMOS memory. When the computer is not plugged into a wall socket, the battery has an estimated life of three years. When the computer is plugged in, the standby current from the power supply extends the life of the battery. The clock is accurate to  $\pm 13$  minutes/year at 25 °C with 3.3 VSB applied.

When the voltage drops below a certain level, the BIOS Setup program settings stored in CMOS RAM (for example, the date and time) might not be accurate. Replace the battery with an equivalent one. Figure 14 on page 46 shows the location of the battery.



### CAUTION

*Risk of explosion if the battery is replaced with an incorrect type. Batteries should be recycled where possible. Disposal of used batteries must be in accordance with local environmental regulations.*



### PRÉCAUTION

*Risque d'explosion si la pile usagée est remplacée par une pile de type incorrect. Les piles usagées doivent être recyclées dans la mesure du possible. La mise au rebut des piles usagées doit respecter les réglementations locales en vigueur en matière de protection de l'environnement.*



### FORHOLDSREGEL

*Ekspløsningsfare, hvis batteriet erstattes med et batteri af en forkert type. Batterier bør om muligt genbruges. Bortskaffelse af brugte batterier bør foregå i overensstemmelse med gældende miljølovgivning.*



### OBS!

*Det kan oppstå eksplosjonsfare hvis batteriet skiftes ut med feil type. Brukte batterier bør kastes i henhold til gjeldende miljølovgivning.*



### VIKTIGT!

*Risk för explosion om batteriet ersätts med felaktig batterityp. Batterier ska kasseras enligt de lokala miljövårdsbestämmelserna.*



### VARO

*Räjähdyksvaara, jos pariston tyyppi on väärä. Paristot on kierrätettävä, jos se on mahdollista. Käytetyt paristot on hävitettävä paikallisten ympäristömääräysten mukaisesti.*



### VORSICHT

*Bei falschem Einsetzen einer neuen Batterie besteht Explosionsgefahr. Die Batterie darf nur durch denselben oder einen entsprechenden, vom Hersteller empfohlenen Batterietyp ersetzt werden. Entsorgen Sie verbrauchte Batterien den Anweisungen des Herstellers entsprechend.*



### AVVERTIMENTO

*Esiste il pericolo di un esplosione se la pila non viene sostituita in modo corretto. Utilizzare solo pile uguali o di tipo equivalente a quelle consigliate dal produttore. Per disfarsi delle pile usate, seguire le istruzioni del produttore.*



### **PRECAUCIÓN**

*Existe peligro de explosión si la pila no se cambia de forma adecuada. Utilice solamente pilas iguales o del mismo tipo que las recomendadas por el fabricante del equipo. Para deshacerse de las pilas usadas, siga igualmente las instrucciones del fabricante.*



### **WAARSCHUWING**

*Er bestaat ontploffingsgevaar als de batterij wordt vervangen door een onjuist type batterij. Batterijen moeten zoveel mogelijk worden gerecycled. Houd u bij het weggooien van gebruikte batterijen aan de plaatselijke milieuwetgeving.*



### **ATENÇÃO**

*Haverá risco de explosão se a bateria for substituída por um tipo de bateria incorreto. As baterias devem ser recicladas nos locais apropriados. A eliminação de baterias usadas deve ser feita de acordo com as regulamentações ambientais da região.*



### **AŚCIAROŹZNAŚĆ**

*Існуе рызыка выбуху, калі заменены акумулятар непраўльнага тыпу. Акумулятары павінны, па магчымасці, перерацоўвацца. Пазбаўляцца ад старых акумулятараў патрэбна згодна з мясцовымі заканадаўствам па экалогіі.*



### **UPOZORNĚNÍ**

*V případě výměny baterie za nesprávný druh může dojít k výbuchu. Je-li to možné, baterie by měly být recyklovány. Baterie je třeba zlikvidovat v souladu s místními předpisy o životním prostředí.*



### **Προσοχή**

*Υπάρχει κίνδυνος για έκρηξη σε περίπτωση που η μπαταρία αντικατασταθεί από μία λανθασμένου τύπου. Οι μπαταρίες θα πρέπει να ανακυκλώνονται όταν κάτι τέτοιο είναι δυνατό. Η απόρριψη των χρησιμοποιημένων μπαταριών πρέπει να γίνεται σύμφωνα με τους κατά τόπο περιβαλλοντικούς κανονισμούς.*



### **VIGYÁZAT**

*Ha a telepet nem a megfelelő típusú telepre cseréli, az felrobbanhat. A telepeket lehetőség szerint újra kell hasznosítani. A használt telepeket a helyi környezetvédelmi előírásoknak megfelelően kell kiselejtezni.*



### **注意**

異なる種類の電池を使用すると、爆発の危険があります。リサイクルが可能な地域であれば、電池をリサイクルしてください。使用後の電池を破棄する際には、地域の環境規制に従ってください。



### **AWAS**

*Risiko letupan wujud jika bateri digantikan dengan jenis yang tidak betul. Bateri sepatutnya dikitar semula jika boleh. Pelupusan bateri terpakai mestilah mematuhi peraturan alam sekitar tempatan.*



### **OSTRZEŻENIE**

*Istnieje niebezpieczeństwo wybuchu w przypadku zastosowania niewłaściwego typu baterii. Zużyte baterie należy w miarę możliwości utylizować zgodnie z odpowiednimi przepisami ochrony środowiska.*



### **PRECAUȚIE**

*Risc de explozie, dacă bateria este înlocuită cu un tip de baterie necorespunzător. Bateriile trebuie reciclate, dacă este posibil. Depozitarea bateriilor uzate trebuie să respecte reglementările locale privind protecția mediului.*



### **ВНИМАНИЕ**

*При использовании батареи несоответствующего типа существует риск ее взрыва. Батареи должны быть утилизированы по возможности. Утилизация батарей должна проводиться по правилам, соответствующим местным требованиям.*



### **UPOZORNENIE**

*Ak batériu vymeníte za nesprávny typ, hrozí nebezpečenstvo jej výbuchu. Batérie by sa mali podľa možnosti vždy recyklovať. Likvidácia použitých batérií sa musí vykonávať v súlade s miestnymi predpismi na ochranu životného prostredia.*



### **POZOR**

*Zamenjava baterije z baterijo drugačnega tipa lahko povzroči eksplozijo. Če je mogoče, baterije reciklirajte. Rabljene baterije zavržite v skladu z lokalnimi okoljevarstvenimi predpisi.*



### **การระวัง**

*ระวังการระเบิดที่เกิดจากเปลี่ยนแบตเตอรี่ผิดประเภท หากเป็นไปได้ ควรนำแบตเตอรี่ไปรีไซเคิล การทิ้งแบตเตอรี่ใช้แล้วต้องเป็นไปตามกฎข้อบังคับด้านสิ่งแวดล้อมของท้องถิ่น.*



### **UYARI**

*Yanlış türde pil takıldığında patlama riski vardır. Piller mümkün olduğunda geri dönüştürülmelidir. Kullanılmış piller, yerel çevre yasalarına uygun olarak atılmalıdır.*



### **ОСТОРОГА**

*Використовуйте батареї правильного типу, інакше існують ризик вибуху. Якщо можливо, використані батареї слід утилізувати. Утилізація використаних батарей має бути виконана згідно місцевих норм, що регулюють охорону довкілля.*

To replace the battery, follow these steps:

1. Observe the precautions in “Before You Begin” (see page 23).
2. Turn off all peripheral devices connected to the computer. Disconnect the computer’s power cord from the AC power source (wall outlet or power adapter).
3. Remove the computer cover.
4. Locate the battery on the board (see Figure 14).
5. With a medium flat-bladed screwdriver, gently pry the battery free from its connector. Note the orientation of the “+” and “-” on the battery.
6. Install the new battery in the connector, orienting the “+” and “-” correctly.
7. Replace the computer cover.

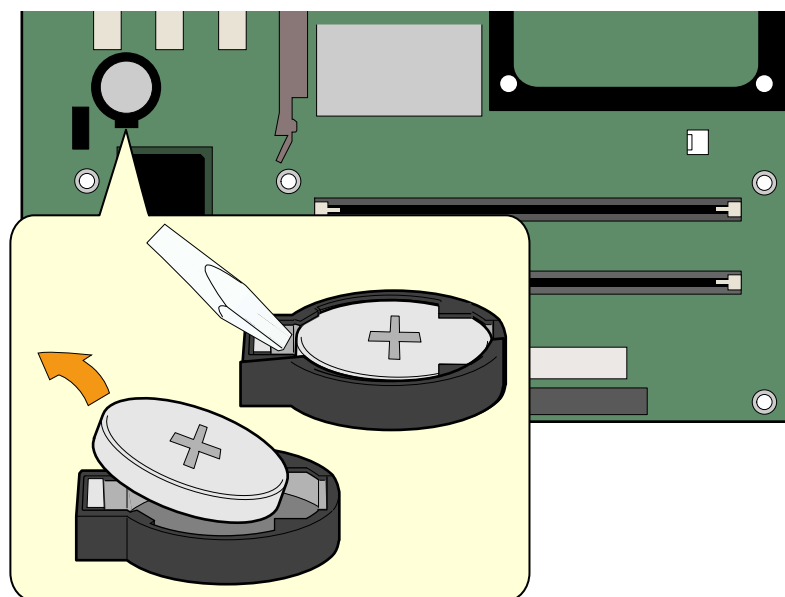

OM16839

Figure 14. Removing the Battery

## 3 Updating the BIOS

---

This chapter tells you how to update the BIOS by either using the Intel® Express BIOS Update utility or the Iflash Memory Update utility, and how to recover the BIOS if an update fails.

### Updating the BIOS with the Intel® Express BIOS Update Utility

With the Intel Express BIOS Update utility you can update the system BIOS while in the Windows environment. The BIOS file is included in an automated update utility that combines the functionality of the Intel® Flash Memory Update Utility and the ease-of use of Windows-based installation wizards.

To update the BIOS with the Intel Express BIOS Update utility:

1. Go to the Intel World Wide Web site:  
<http://support.intel.com/support/motherboards/desktop/>
2. Navigate to the Desktop Board D865PCD page and click the Express BIOS Update utility file for the Desktop Board D865PCD BIOS.
3. Download the file to your hard drive. (You can also save this file to a diskette. This is useful if you are updating the BIOS for multiple identical systems.)
4. Close all other applications. This step is required. Your system will be rebooted at the last Express BIOS Update window.
5. Double-click the executable file from the location on your hard drive where it was saved. This runs the update program.
6. Follow the instructions provided in the dialog boxes to complete the BIOS update.

## Updating the BIOS with the Iflash Memory Update Utility

With the Iflash Memory Update utility you can update the system BIOS from a floppy disk or other bootable media. The utility available from the Web provides a simple method for creating a bootable flash memory update floppy that will automatically update your BIOS.

### Obtaining the BIOS Update File

You can update to a new version of the BIOS by using the BIOS update file. The BIOS update file is a compressed self-extracting archive that contains all the files you need to update the BIOS. The BIOS update file contains:

- New BIOS files
- BIOS recovery files
- Iflash Memory Update utility

You can obtain the BIOS update file through your computer supplier or by navigating to the Desktop Board D865PCD page on the Intel World Wide Web site:

<http://support.intel.com/support/motherboards/desktop>



#### **NOTE**

*Review the instructions distributed with the update utility before attempting a BIOS update.*

The Intel Flash Memory Update Utility allows you to:

- Update the BIOS in flash memory
- Update the language section of the BIOS

### Updating the BIOS



#### **CAUTION**

*The AUTOEXEC.BAT file provided with the update files updates the BIOS. Do not interrupt the process or the system may not function.*

1. Boot the computer with the BIOS update diskette in drive A. During system boot, the AUTOEXEC.BAT file provided with the update files will automatically run the BIOS update process.
2. When the update process is complete, the monitor will display a message telling you to remove the diskette and to reboot the system.
3. As the computer boots, check the BIOS identifier (version number) to make sure the update was successful. If a logo appears, press <Esc> to view the POST messages.



## Recovering the BIOS

It is unlikely that anything will interrupt the BIOS update; however, if an interruption occurs, the BIOS could be damaged. The following steps explain how to recover the BIOS if an update fails. The following procedure uses recovery mode for the Setup program. See page 40 for more information on Setup modes.



### NOTE

*Because of the small amount of code available in the boot block area, there is no video support. You will not see anything on the screen during this procedure. Monitor the procedure by listening to the speaker and looking at the diskette drive LED.*

1. Turn off the computer, disconnect the computer's power cord, and disconnect all external peripherals.
2. Remove the computer cover and locate the configuration jumper block (see Figure 12).
3. Remove the jumper from all pins as shown below to set recovery mode for Setup.
4. Insert the bootable BIOS update diskette into diskette drive A.
5. Replace the computer cover, connect the power cord, turn on the computer, and allow it to boot. The recovery process will take a few minutes.
6. Listen to the speaker:
  - Upon applying power, drive A will begin to show activity. In about a minute, two beeps are heard and drive A activity ceases (temporarily) indicating the successful recovery of the BIOS core. Drive A activity will begin again followed by two more beeps indicating the successful recovery of the boot block. This sequence of events indicates a successful BIOS recovery.
  - A series of continuous beeps indicates a failed BIOS recovery.
7. If recovery fails, return to step 1 and repeat the recovery process.
8. If recovery is successful, turn off the computer, and disconnect its power cord.
9. Remove the computer cover and continue with the following steps.
10. On the jumper block, reinstall the jumper back on pins 1-2 as shown below to set normal mode for Setup.



11. Leave the update diskette in drive A, replace the computer cover, and connect the computer's power cord.
12. Turn on the computer and continue with the BIOS update.



# 4 Using the BIOS Setup Program

The BIOS Setup program can be used to view and change the BIOS settings for the computer. The BIOS Setup program is accessed by pressing the <F2> key after the Power-On Self-Test (POST) memory test begins and before the operating system boot begins.



## NOTE

*The BIOS Setup menus described in this section may not show the latest settings. For the latest BIOS settings, refer to the Intel® Desktop Board D865PCD Technical Product Specification or the Intel World Wide Web site:*

<http://support.intel.com/support/motherboards/desktop>



## NOTE

*For reference purposes, you should write down the current Setup settings. When you make changes to the settings, update this record.*



## NOTE

*The Setup menus described in this section apply to the desktop boards with BIOS identifier RC865.10A.86A. Boards with other BIOS identifiers might have differences in some of the Setup menu screens.*

Table 9 shows the BIOS Setup program menu bar.

**Table 9. BIOS Setup Program Menu Bar**

| Maintenance   | Main  | Advanced   | Security                             | Power                                | Boot   | Exit   |  |  |
|---|---|--|--------------------------------------|--------------------------------------|--|--|--|--|
| Clears passwords and Boot Integrity Service (BIS)* credentials, and configures extended configuration memory settings | Allocates resources for hardware components | Configures advanced features available through the chipset | Sets passwords and security features | Configures power management features | Selects boot options and power supply controls | Saves or discards changes to set program options |  |  |

\* For information about the BIS, refer to the Intel Web site at:

<http://developer.intel.com/design/security/index1.htm>

Table 10 shows the function keys available for menu screens.

**Table 10. BIOS Setup Program Function Keys**

| BIOS Setup Program Function Key | Description  |
|---------------------------------|--|
| <<-> or <->>                    | Selects a different menu screen                            |
| <↑> or <↓>                      | Moves cursor up or down                                    |
| <Tab>                           | Moves cursor to the next field                             |
| <Enter>                         | Executes command or selects the submenu                    |
| <F9>                            | Load the default configuration values for the current menu |
| <F10>                           | Save the current values and exits the BIOS Setup program   |
| <Esc>                           | Exits the menu   |

## Maintenance Menu

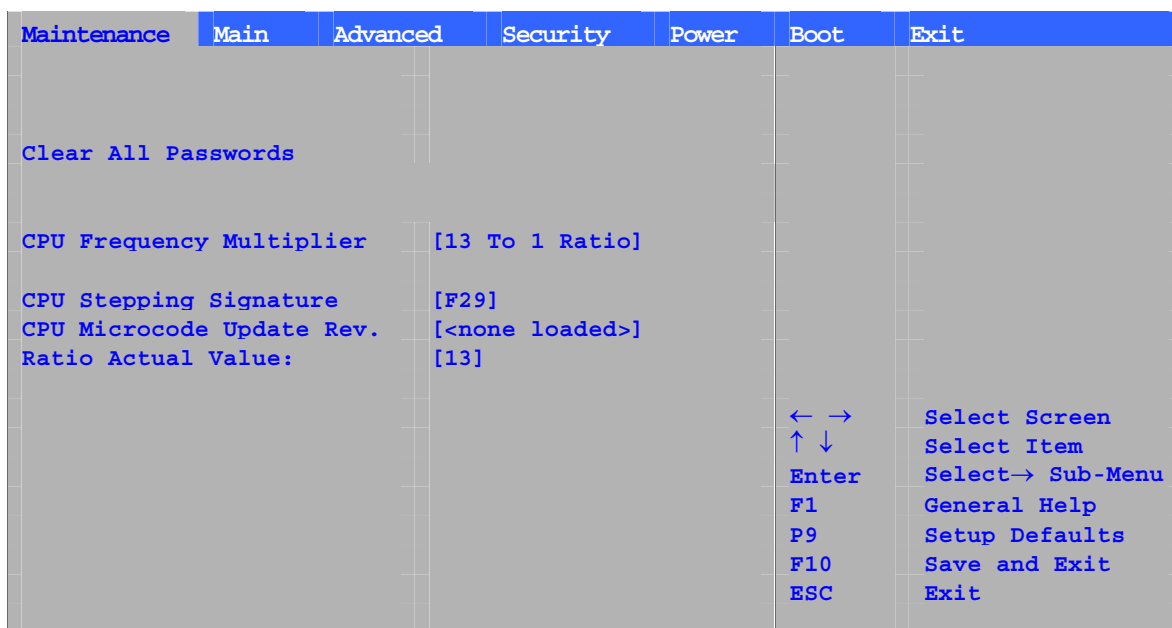

The menu shown in Table 11 is used to clear the Setup passwords. Setup only displays this menu in configure mode. See page 40 for information about setting configure mode.

**Table 11. Maintenance Menu**

| Feature                       | Options  | Description   |
|-------------------------------|--|---|
| Clear All Passwords           | <ul style="list-style-type: none"> <li>• Ok</li> <li>• Cancel</li> </ul> | Clears both the user and supervisor BIOS passwords. |
| Clear Trusted Platform Module | <ul style="list-style-type: none"> <li>• Ok</li> <li>• Cancel</li> </ul> | Clears Ownership and all keys from the TPM.         |
| CPU Frequency                 | No options   | Displays CPU frequency.                             |
| CPU Stepping Signature        | No options   | Displays processor's Stepping Signature.            |
| CPU Microcode Update Revision | No options   | Displays processor's Microcode Update Revision.     |
| Ratio Actual Value            | No options   | Displays ratio value.                               |

## Main Menu

| Main                       | Advanced | Security              | Power | Boot  | Exit              |
|----------------------------|----------|-----------------------|-------|-------|-------------------|
| BIOS Version               |          | xxxxx10A.86A.xxxx.xxx |       |       |                   |
| Processor Type             |          | Intel® Pentium® 4     |       |       |                   |
| Hyper-Threading Technology |          | [Enabled]             |       |       |                   |
| Processor Speed            |          | X.XX GHz              |       |       |                   |
| System Bus Speed           |          | XXX MHz               |       |       |                   |
| System Memory Speed        |          | XXX MHz               |       |       |                   |
| Cache RAM                  |          | XXX KB                |       |       |                   |
| Total Memory               |          | XXX MB                |       |       |                   |
| Memory Mode                |          | Dual Channel          |       |       |                   |
| Memory Channel A Slot 0    |          | XXX MB (DDRYYY)       |       |       |                   |
| Memory Channel A Slot 1    |          | Not Installed         |       | ← →   | Select Screen     |
| Memory Channel B Slot 0    |          | XXX MB (DDRYYY)       |       | ↑ ↓   | Select Item       |
| Memory Channel B Slot 1    |          | Not Installed         |       | Enter | Select ► Sub-Menu |
| Language                   |          | [English]             |       | F1    | General Help      |
|                            |          |                       |       | P9    | Setup Defaults    |
|                            |          |                       |       | F10   | Save and Exit     |
|                            |          |                       |       | ESC   | Exit              |
| System Time                |          | [xx.xx.xx]            |       |       |                   |

Table 12 describes the Main Menu. This menu reports processor and memory information and is used to configure the system date and system time.

**Table 12. Main Menu**

| Feature                    | Options  | Description  |
|----------------------------|--|--|
| BIOS Version               | No options   | Displays the version of the BIOS.  |
| Processor Type             | No options   | Displays processor type.   |
| Hyper-Threading Technology | <ul style="list-style-type: none"> <li>• <b>Enabled (default)</b></li> <li>• Disabled</li> </ul> | Enables or disables Hyper-Threading Technology.                                  |
| Processor Speed            | No options   | Displays processor speed.  |
| System Bus Speed           | No options   | Displays the system bus speed.   |
| System Memory Speed        | No options   | Displays the current system memory speed.  |
| Cache RAM                  | No options   | Displays the size of second-level cache and whether it is ECC-capable.           |
| Total Memory               | No options   | Displays the total amount of RAM.  |
| Memory Mode                | No options   | Displays the amount and type (as defined by SPD) of the RAM in the memory banks. |
| Language                   | <ul style="list-style-type: none"> <li>• <b>English (default)</b></li> <li>• Français</li> </ul> | Selects the current default language used by the BIOS.                           |
| System Time                | Hour, minute, and second   | Specifies the current time.  |

## Advanced Menu

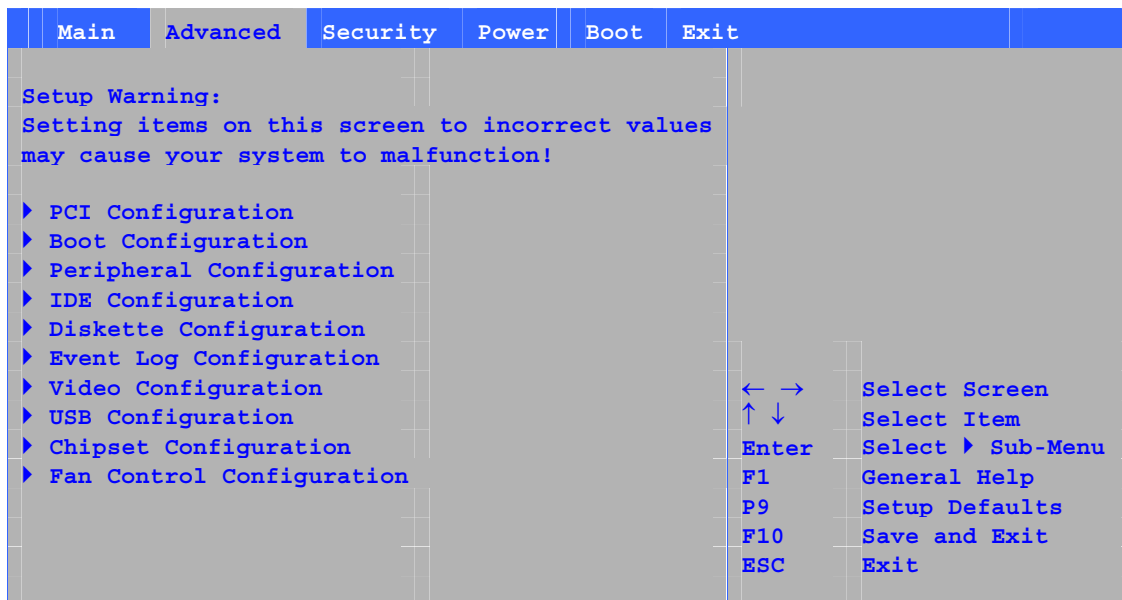
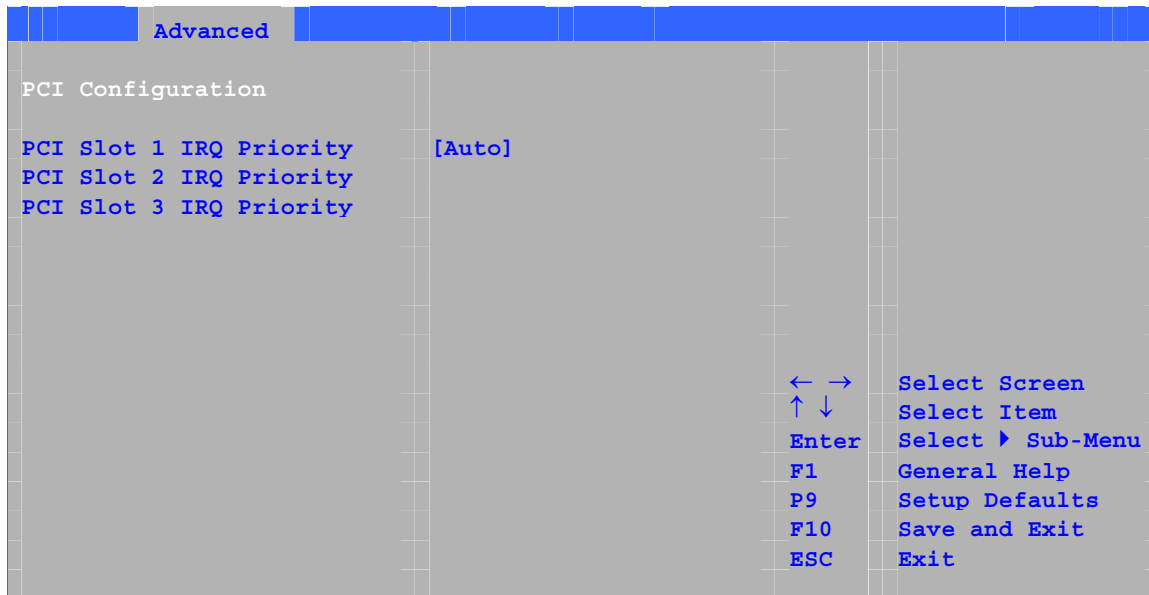

Table 13 describes the Advanced Menu. This menu is used to set advanced features that are available through the chipset.

**Table 13. Advanced Menu**

| Feature                   | Options    | Description  |
|---------------------------|------------|--|
| PCI Configuration         | No options | Configures individual PCI slot's IRQ priority. When selected, displays the PCI Configuration submenu.                              |
| Boot Configuration        | No options | Configures Plug & Play and the Numlock key, and resets configuration data. When selected, displays the Boot Configuration submenu. |
| Peripheral Configuration  | No options | Configures peripheral ports and devices. When selected, displays the Peripheral Configuration submenu.                             |
| IDE Configuration         | No options | Specifies type of connected IDE device.  |
| Diskette Configuration    | No options | Configures the floppy drive(s). When selected, displays the Diskette Configuration submenu.  |
| Event Log Configuration   | No options | Configures event logging. When selected, displays the Event Log Configuration submenu.   |
| Video Configuration       | No options | Configures video features. When selected, displays the Video Configuration submenu.  |
| USB Configuration         | No options | Configures USB features. When selected, displays the USB Configuration submenu.  |
| Chipset Configuration     | No options | Configures chipset features. When selected, displays the Chipset Configuration submenu.  |
| Fan Control Configuration | No options | Configures fan control features. When selected, displays the Fan Control Configuration submenu.                                    |

## PCI Configuration Submenu



The submenu shown in Table 14 is used to configure the IRQ priority of PCI slots individually.

**Table 14. PCI Configuration Submenu**

| Feature   | Options  | Description                       |
|---|--|-----------------------------------|
| PCI Slot 1 IRQ Priority<br>PCI Slot 2 IRQ Priority<br>PCI Slot 3 IRQ Priority | <ul style="list-style-type: none"> <li>• <b>Auto (default)</b></li> <li>• 3</li> <li>• 5</li> <li>• 9</li> <li>• 10</li> <li>• 11</li> </ul> | Allows selection of IRQ priority. |

## Boot Configuration Submenu

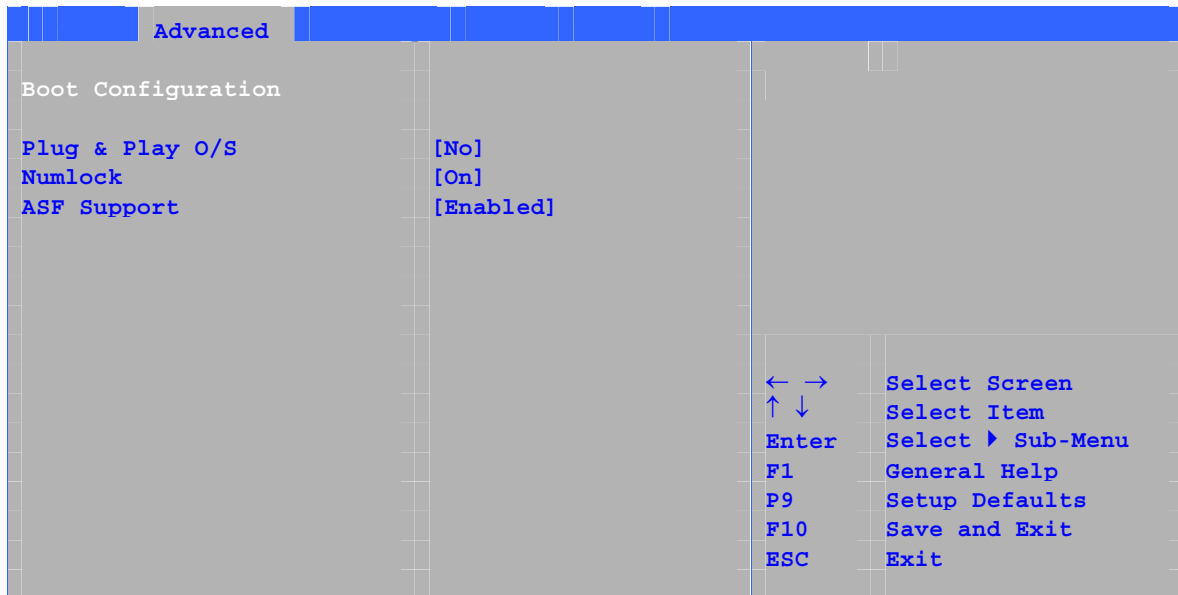

The submenu shown in Table 15 is used to set the Plug & Play options and the power-on state of the Numlock key.

**Table 15. Boot Configuration Submenu**

| Feature         | Options  | Description   |
|-----------------|--|---|
| Plug & Play O/S | <ul style="list-style-type: none"> <li>• <b>No (default)</b></li> <li>• Yes</li> </ul>           | <p>Specifies if manual configuration is desired.</p> <p><i>No</i> lets the BIOS configure all devices in the system. This setting is appropriate when using a Plug and Play operating system.</p> <p><i>Yes</i> lets the operating system configure Plug &amp; Play (PnP) devices not required for boot if your system has a Plug &amp; Play operating system. This option is available for use during lab testing.</p> |
| Numlock         | <ul style="list-style-type: none"> <li>• Off</li> <li>• <b>On (default)</b></li> </ul>           | <p>Specifies the power-on state of the Numlock feature on the numeric keypad of the keyboard.</p>   |
| ASF Support     | <ul style="list-style-type: none"> <li>• Disabled</li> <li>• <b>Enabled (default)</b></li> </ul> | <p>Configures LAN ASF (Alert Standard Format) feature.</p>  |



## Peripheral Configuration Submenu

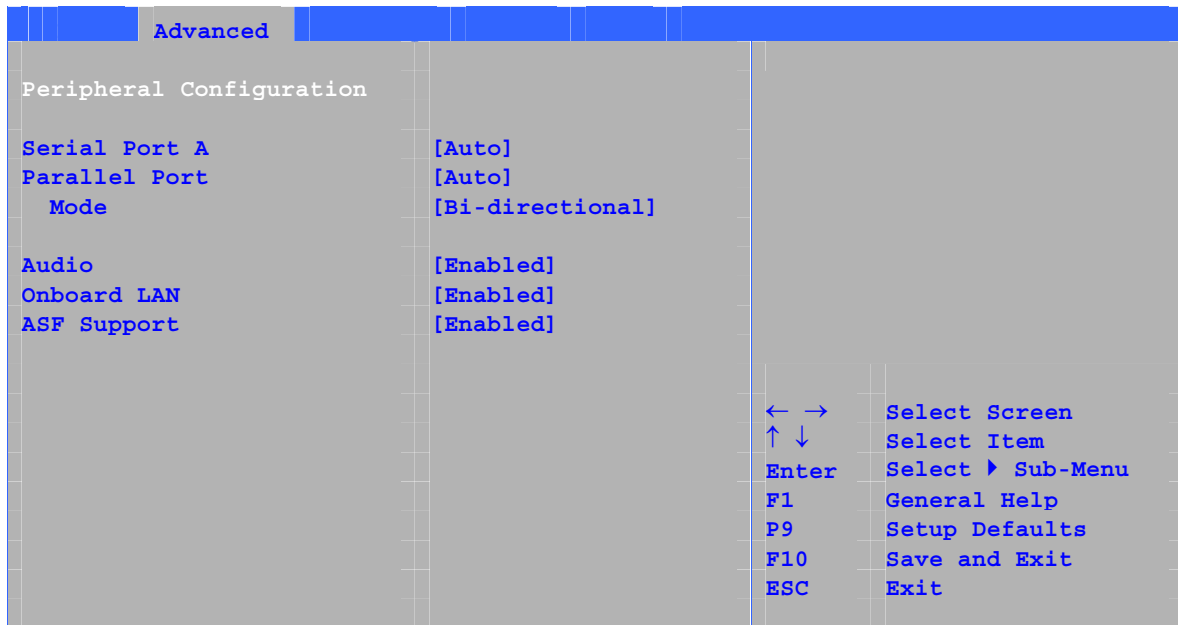

This submenu shown in Table 16 is used for configuring computer peripherals.

**Table 16. Peripheral Configuration Submenu**

| Feature   | Options   | Description  |
|---|---|--|
| Serial Port A   | <ul style="list-style-type: none"> <li>Disabled</li> <li>Enabled</li> <li><b>Auto (default)</b></li> </ul>    | Configures serial port A. <i>Auto</i> assigns the first free COM port, normally COM1, the address 3F8h, and the interrupt IRQ4. An * (asterisk) displayed next to an address indicates a conflict with another device. |
| Base I/O Address<br>(This feature is present only when Serial Port A is set to <i>Enabled</i> ) | <ul style="list-style-type: none"> <li><b>3F8 (default)</b></li> <li>2F8</li> <li>3E8</li> <li>2E8</li> </ul> | Specifies the base I/O address for serial port A, if serial port A is Enabled.   |
| Interrupt<br>(This feature is present only when Serial Port A is set to <i>Enabled</i> )        | <ul style="list-style-type: none"> <li>IRQ 3</li> <li><b>IRQ 4 (default)</b></li> </ul>                       | Specifies the interrupt for serial port A, if serial port A is Enabled.  |
| Parallel Port   | <ul style="list-style-type: none"> <li>Disabled</li> <li>Enabled</li> <li><b>Auto (default)</b></li> </ul>    | Configures the parallel port. <i>Auto</i> assigns LPT1 the address 378h and the interrupt IRQ7. An * (asterisk) displayed next to an address indicates a conflict with another device.                                 |

continued

**Table 16. Peripheral Configuration Submenu** (continued)

| Feature   | Options  | Description  |
|---|--|--|
| Mode  | <ul style="list-style-type: none"> <li>• Output only</li> <li>• <b>Bi-directional (default)</b></li> <li>• EPP</li> <li>• ECP</li> </ul> | <p>Selects the mode for the parallel port. Not available if the parallel port is disabled.</p> <p><i>Output Only</i> operates in AT*-compatible mode.</p> <p><i>Bi-directional</i> operates in PS/2-compatible mode.</p> <p><i>EPP</i> is Extended Parallel Port mode, a high-speed bi-directional mode.</p> <p><i>ECP</i> is Enhanced Capabilities Port mode, a high-speed bi-directional mode.</p> |
| Base I/O Address<br>(This feature is present only when Parallel Port is set to <i>Enabled</i> ) | <ul style="list-style-type: none"> <li>• <b>378 (default)</b></li> <li>• 278</li> </ul>  | Specifies the base I/O address for the parallel port, if Parallel Port is Enabled.   |
| Interrupt<br>(This feature is present only when Parallel Port is set to <i>Enabled</i> )        | <ul style="list-style-type: none"> <li>• IRQ 5</li> <li>• <b>IRQ 7 (default)</b></li> </ul>  | Specifies the interrupt for the parallel port, if Parallel Port is Enabled.  |
| Audio   | <ul style="list-style-type: none"> <li>• Disabled</li> <li>• <b>Enabled (default)</b></li> </ul>   | Enables or disables onboard audio.   |
| Onboard LAN<br>(This feature is present only when there is onboard LAN)                         | <ul style="list-style-type: none"> <li>• Disabled</li> <li>• <b>Enabled (default)</b></li> </ul>   | Enables or disables the LAN device.  |
| ASF Support   | <ul style="list-style-type: none"> <li>• Disabled</li> <li>• <b>Enabled (default)</b></li> </ul>   | Enables or disables Alert Standard Format  |

## ATA/IDE Configuration Submenu

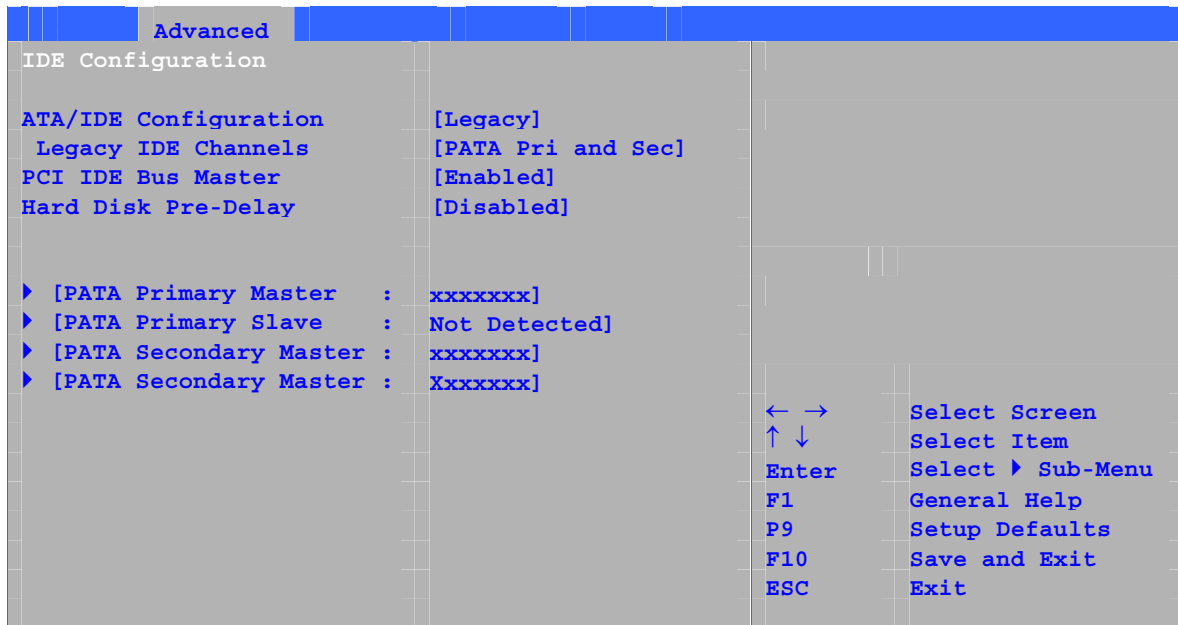

This submenu shown in Table 17 is used to configure IDE device options.

**Table 17. ATA/IDE Configuration Submenu**

| Feature               | Options  | Description  |
|-----------------------|--|--|
| ATA/IDE Configuration | <ul style="list-style-type: none"> <li>Disabled</li> <li>Legacy</li> <li><b>Enhanced (default)</b></li> </ul>  | Specifies the integrated IDE controller.<br><i>Disabled</i> disables the integrated IDE controller.<br><i>Legacy</i> enables up to two IDE channels for OS requiring legacy IDE operation.<br><i>Enhanced</i> all SATA and PATA resources. |
| Legacy IDE Channels   | <ul style="list-style-type: none"> <li>PATA Pri only</li> <li>PATA Sec only</li> <li><b>PATA Pri and Sec (default)</b></li> <li>SATA P0/P1 only</li> <li>SATA P0/P1, PATA Sec</li> <li>SATA P0/P1, PATA Pri</li> </ul> | Configures PATA and SATA resources for OS requiring legacy IDE operation.  |
| PCI IDE Bus Master    | <ul style="list-style-type: none"> <li>Disabled</li> <li><b>Enabled (default)</b></li> </ul>   | Allows a PCI device to initiate a transaction as a master.   |
| Hard Disk Pre-Delay   | <ul style="list-style-type: none"> <li><b>Disabled (default)</b></li> <li>3 Seconds</li> <li>6 Seconds</li> <li>9 Seconds</li> <li>12 Seconds</li> <li>15 Seconds</li> <li>21 Seconds</li> <li>30 Seconds</li> </ul>   | Specifies the hard disk drive pre-delay. Causes the BIOS to insert a delay before attempting to detect IDE drives in the system.   |

**NOTE:** SATA hard drives are not supported on desktop board D865PCD.

## PATA Submenu

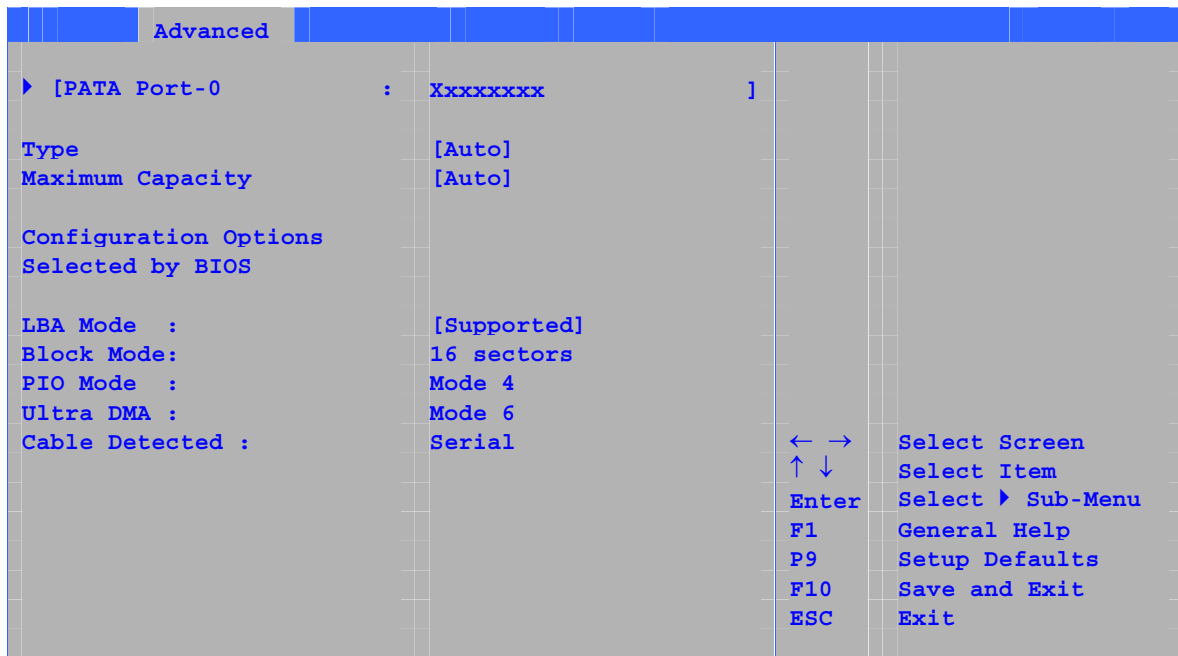

There are four IDE submenus: Primary master, primary slave, secondary master, and secondary slave. Table 18 shows the format of these IDE submenus. For brevity, only one example is shown.

**Table 18. PATA Submenus**

| Feature                    | Options  | Description   |
|----------------------------|--|---|
| Drive Installed            | None   | Displays the type of drive installed.   |
| Type                       | <ul style="list-style-type: none"> <li>• <b>Auto (default)</b></li> <li>• User</li> </ul>  | Specifies the IDE configuration mode for IDE devices. <i>Auto</i> fills-in capabilities from ATA/ATAPI device. <i>User</i> allows capabilities to be changed. |
| Maximum Capacity           | None   | Displays the capacity of the drive.   |
| LBA Mode Control<br>(Note) | None   | Specifies LBA mode control.   |
| Block Mode                 | <ul style="list-style-type: none"> <li>• Disabled</li> <li>• <b>Auto (default)</b></li> </ul>  | Check the hard disk drive's specifications for optimum setting.   |
| PIO Mode<br>(Note)         | <ul style="list-style-type: none"> <li>• <b>Auto (default)</b></li> <li>• 0</li> <li>• 1</li> <li>• 2</li> <li>• 3</li> <li>• 4</li> </ul> | Specifies the PIO mode.   |

**NOTE:** SATA hard drives are not supported on desktop board D865PCD.

continued

**Table 18. SATA and PATA Submenus** (continued)

| Feature                  | Options   | Description   |
|--------------------------|---|---|
| DMA Mode                 | <ul style="list-style-type: none"> <li>• <b>Auto (default)</b></li> <li>• SWDMA 0</li> <li>• SWDMA 1</li> <li>• SWDMA 2</li> <li>• MWDMA 0</li> <li>• MWDMA 1</li> <li>• MWDMA 2</li> <li>• UDMA 0</li> <li>• UDMA 1</li> <li>• UDMA 2</li> <li>• UDMA 3</li> <li>• UDMA 4</li> <li>• UDMA 5</li> </ul> | Specifies the Ultra DMA mode for the drive.   |
| S.M.A.R.T.               | <ul style="list-style-type: none"> <li>• <b>Auto (default)</b></li> <li>• Disable</li> <li>• Enable</li> </ul>  | Self-monitoring analysis and reporting technology.  |
| Cable Detected<br>(Note) | None  | Displays the type of cable connected to the IDE interface: 40-conductor or 80-conductor (for ATA-66/100 devices) or Serial ATA. |

Note: These configuration options appear only if an IDE device is installed.

## Diskette Configuration Submenu

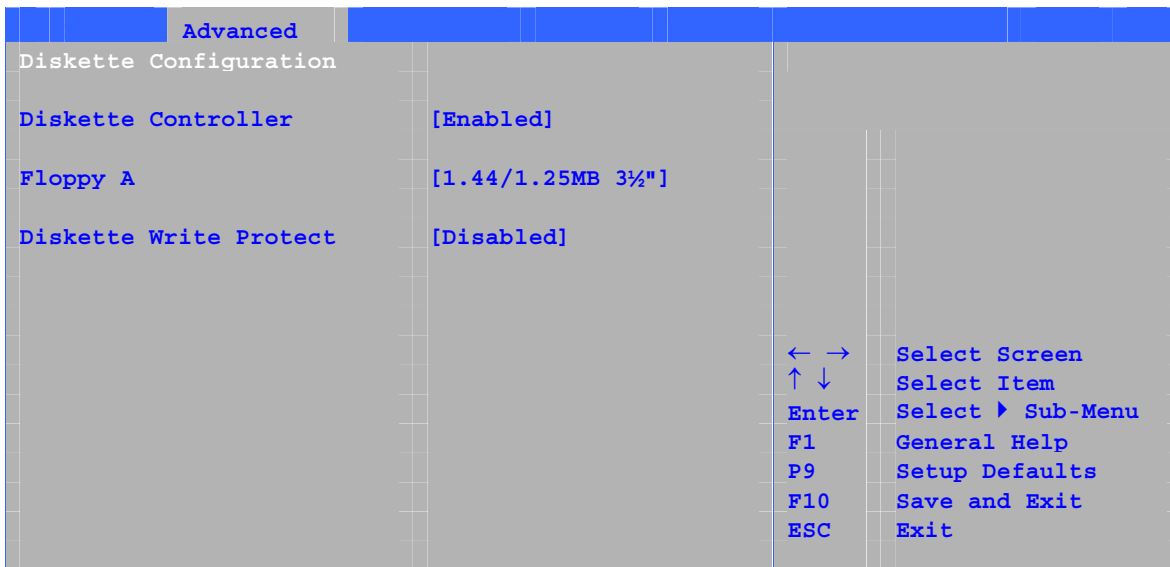

This submenu shown in Table 19 is used to configure the floppy drive.

**Table 19. Diskette Configuration Submenu**

| Feature                | Options   | Description  |
|------------------------|---|--|
| Diskette Controller    | <ul style="list-style-type: none"> <li>Disabled</li> <li><b>Enabled (default)</b></li> </ul>  | Configures the integrated floppy controller.         |
| Floppy A               | <ul style="list-style-type: none"> <li>Disabled</li> <li>360 KB 5¼"</li> <li>1.2 MB 5¼"</li> <li>720 KB 3½"</li> <li><b>1.44 MB 3½" (default)</b></li> <li>2.88 MB 3½"</li> </ul> | Selects the floppy drive type.                       |
| Diskette Write Protect | <ul style="list-style-type: none"> <li><b>Disabled (default)</b></li> <li>Enabled</li> </ul>  | Disables or enables diskette drive write protection. |

## Event Log Configuration Submenu

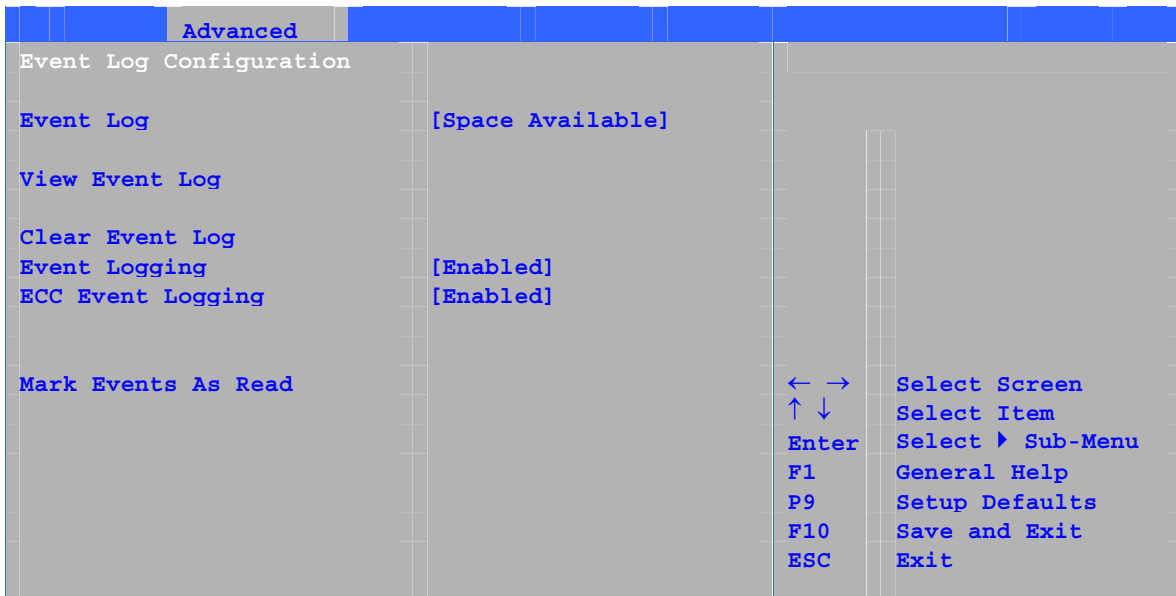

The submenu shown in Table 20 is used to configure the event logging features.

**Table 20. Event Log Configuration Submenu**

| Feature             | Options  | Description   |
|---------------------|--|---|
| Event Log           | No options   | Indicates if there is space available in the event log. |
| View Event Log      | [Enter]  | Displays the contents of the DMI event log.             |
| Clear Event Log     | No options   | Discards all events in the event log.                   |
| Event Logging       | <ul style="list-style-type: none"> <li>Disabled</li> <li><b>Enabled (default)</b></li> </ul> | Enables or disables event logging.                      |
| ECC Event Logging   | <ul style="list-style-type: none"> <li>Disabled</li> <li><b>Enabled (default)</b></li> </ul> | <i>Enabled</i> allows logging of DMI events.            |
| Mark Events As Read | [Enter]  | Marks all DMI events in the event log as read.          |

## Video Configuration Submenu

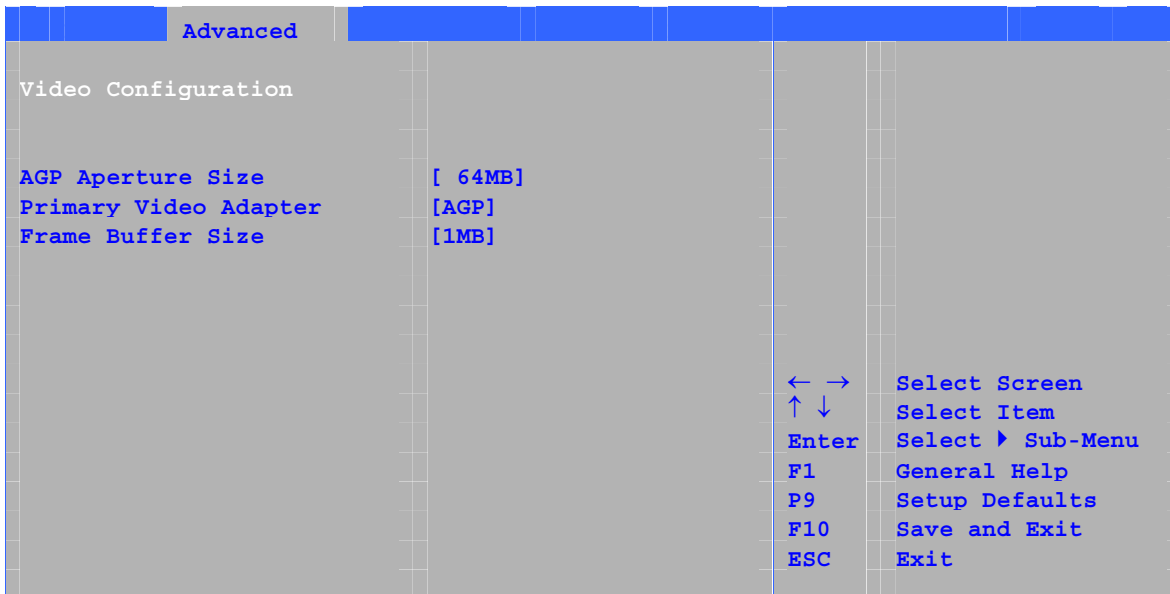

The submenu shown in Table 21 is used to configure video features.

**Table 21. Video Configuration Submenu**

| Feature               | Options  | Description  |
|-----------------------|--|--|
| AGP Aperture Size     | <ul style="list-style-type: none"> <li>• 4 MB</li> <li>• 8 MB</li> <li>• 16 MB</li> <li>• 32 MB</li> <li>• <b>64 MB (default)</b></li> <li>• 128 MB</li> <li>• 256 MB</li> </ul> | Amount of system memory available for direct access by the graphics device.                                      |
| Primary Video Adapter | <ul style="list-style-type: none"> <li>• <b>AGP (default)</b></li> <li>• PCI</li> </ul>  | Allows selecting an AGP or PCI video controller as the display device that will be active when the system boots. |
| Frame Buffer Size     | <ul style="list-style-type: none"> <li>• 512 KB</li> <li>• <b>1 MB (default)</b></li> <li>• 8 MB</li> </ul>  | Controls how much system RAM is reserved for use by the internal graphics device.                                |



## USB Configuration Submenu

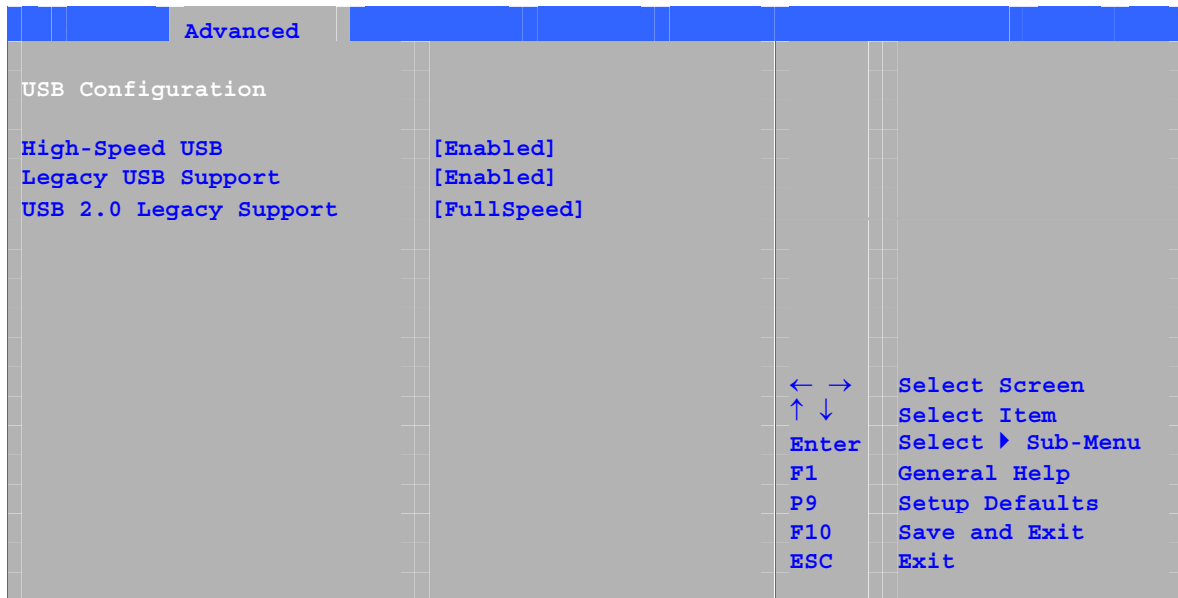

The submenu shown in Table 22 is used to configure USB features.

**Table 22. USB Configuration Submenu**

| Feature                | Options   | Description   |
|------------------------|---|---|
| High Speed USB         | <ul style="list-style-type: none"> <li>Disabled</li> <li><b>Enabled (default)</b></li> </ul>    | Disable this option when a USB 2.0 driver is not available.                       |
| Legacy USB Support     | <ul style="list-style-type: none"> <li>Disabled</li> <li><b>Enabled (default)</b></li> </ul>    | Enables support for legacy USB.   |
| USB 2.0 Legacy Support | <ul style="list-style-type: none"> <li><b>Full Speed (default)</b></li> <li>Hi Speed</li> </ul> | Configures Legacy USB transfer rate:<br>Full Speed: 12 Mbps<br>Hi Speed: 480 Mbps |

## Chipset Configuration Submenu

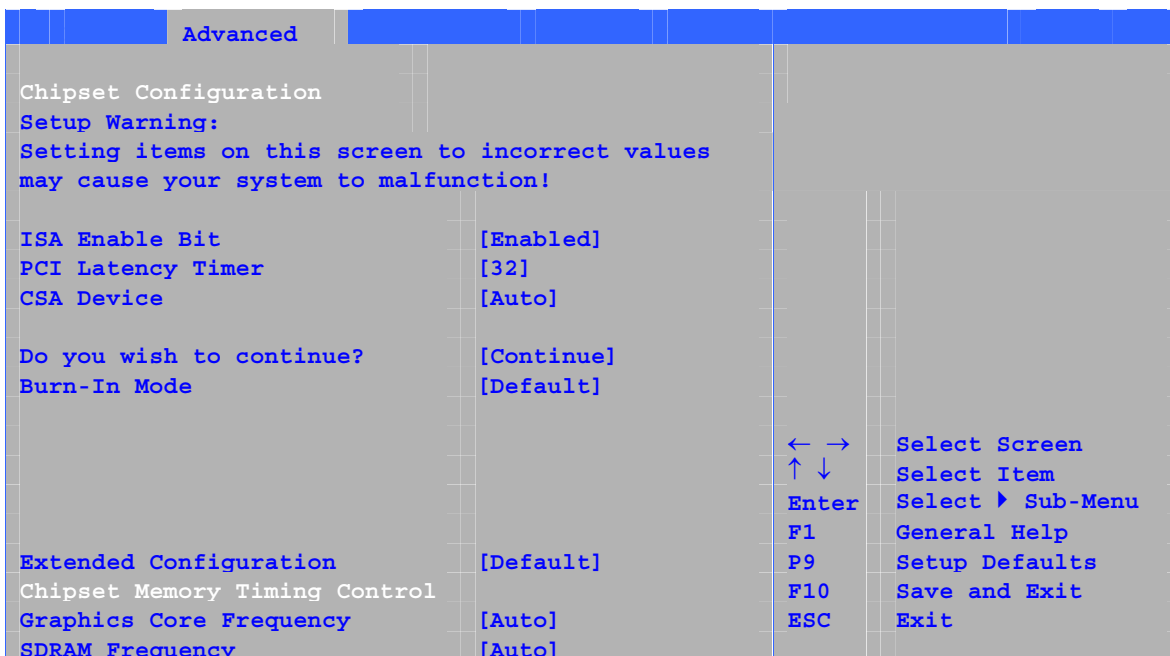

The submenu shown in Table 23 is used to configure advanced chipset features.

**Table 23. Chipset Configuration Submenu**

| Feature                  | Options   | Description   |
|--------------------------|---|---|
| ISA Enable Bit           | <ul style="list-style-type: none"> <li>Enabled (default)</li> <li>Disabled</li> </ul>   | Some older expansion devices require this option to be enabled. |
| PCI Latency Timer        | <ul style="list-style-type: none"> <li>32 (default)</li> <li>64</li> <li>96</li> <li>128</li> <li>160</li> <li>192</li> <li>224</li> <li>248</li> </ul>       | Set PCI latency time.   |
| CSA Device               | <ul style="list-style-type: none"> <li>Auto (default)</li> <li>Disable</li> </ul>   |   |
| Do you wish to continue? | <ul style="list-style-type: none"> <li>No (default)</li> <li>Continue</li> </ul>  |   |
| Burn-In Mode             | <ul style="list-style-type: none"> <li>Default (default)</li> <li>-2.0%</li> <li>-1.0%</li> <li>+1.0%</li> <li>+2.0%</li> <li>+3.0%</li> <li>+4.0%</li> </ul> | Alters host and I/O clock frequencies.                          |

continued

**Table 23. Chipset Configuration Submenu** (continued)

| Feature                  | Options   | Description   |
|--------------------------|---|---|
| Extended Configuration   | <ul style="list-style-type: none"> <li>• <b>Default (default)</b></li> <li>• User Defined</li> </ul>                                      | Chooses the default or user defined settings for the extended configuration options.  |
| Graphics Core Frequency  | <ul style="list-style-type: none"> <li>• <b>Auto (default)</b></li> <li>• 266 MHz</li> <li>• 333-320 MHz</li> </ul>                       | Allows override of detected graphics core frequency value.  |
| SDRAM Frequency          | <ul style="list-style-type: none"> <li>• <b>Auto (default)</b></li> <li>• 266 MHz</li> <li>• 333 MHz</li> <li>• 400 MHz</li> </ul>        | Allows override of detected memory frequency value.   |
| SDRAM Timing Control     | <ul style="list-style-type: none"> <li>• <b>Auto (default)</b></li> <li>• Manual – Aggressive</li> <li>• Manual – User Defined</li> </ul> | <p><i>Auto</i> allows timings to be programmed according to the memory detected.</p> <p><i>Manual – Aggressive</i> selects the most aggressive user defined timings.</p> <p><i>Manual – User Defined</i> allows manual override of detected SDRAM settings.</p> |
| CPC Override             | <ul style="list-style-type: none"> <li>• <b>Auto (default)</b></li> <li>• Enabled</li> <li>• Disabled</li> </ul>                          | Controls Command Per Clock/1n rule mode. When enabled, allows DRAM controller to attempt Chip Select assertions in two consecutive common clocks.   |
| SDRAM RAS Act. To Pre.   | <ul style="list-style-type: none"> <li>• <b>8 (default)</b></li> <li>• 7</li> <li>• 6</li> <li>• 5</li> </ul>                             | Selects length of time from read to pre-change. Corresponds to tRAS, min.   |
| SDRAM CAS# Latency       | <ul style="list-style-type: none"> <li>• 2.0</li> <li>• 2.5</li> <li>• <b>3.0 (default)</b></li> </ul>                                    | Selects the number of clock cycles required to address a column in memory. Corresponds to CL.   |
| SDRAM RAS# to CAS# delay | <ul style="list-style-type: none"> <li>• 4</li> <li>• <b>3 (default)</b></li> <li>• 2</li> </ul>  | Selects the number of clock cycles between addressing a row and addressing a column. Corresponds to tRCD.   |
| SDRAM RAS# Precharge     | <ul style="list-style-type: none"> <li>• 4</li> <li>• <b>3 (default)</b></li> <li>• 2</li> </ul>  | Selects the length of time required before accessing a new row.   |

## Fan Control Submenu

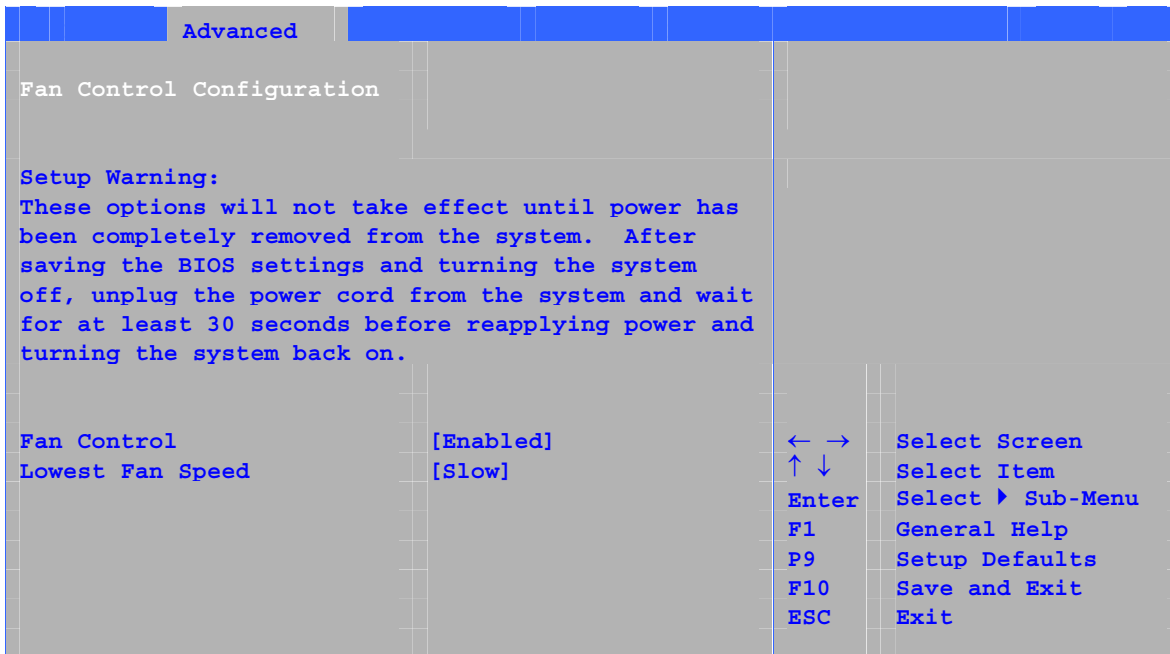

The menu shown in Table 24 is used to configure hardware management features.

**Table 24. Hardware Management**

| Feature          | Options  | Description  |
|------------------|--|--|
| Fan Control      | <ul style="list-style-type: none"> <li>• Disabled</li> <li>• <b>Enabled (default)</b></li> </ul> | Disables or enables system fan control.  |
| Lowest Fan Speed | <ul style="list-style-type: none"> <li>• <b>Slow (default)</b></li> <li>• Off</li> </ul>         | <p>This option defines the fan speed at the lowest system temperature.</p> <p><i>Slow</i> allows the fans to continue to run at a reduced speed at low system temperatures.</p> <p><i>Off</i> turns off the fans at low system temperatures.</p> |

## Security Menu

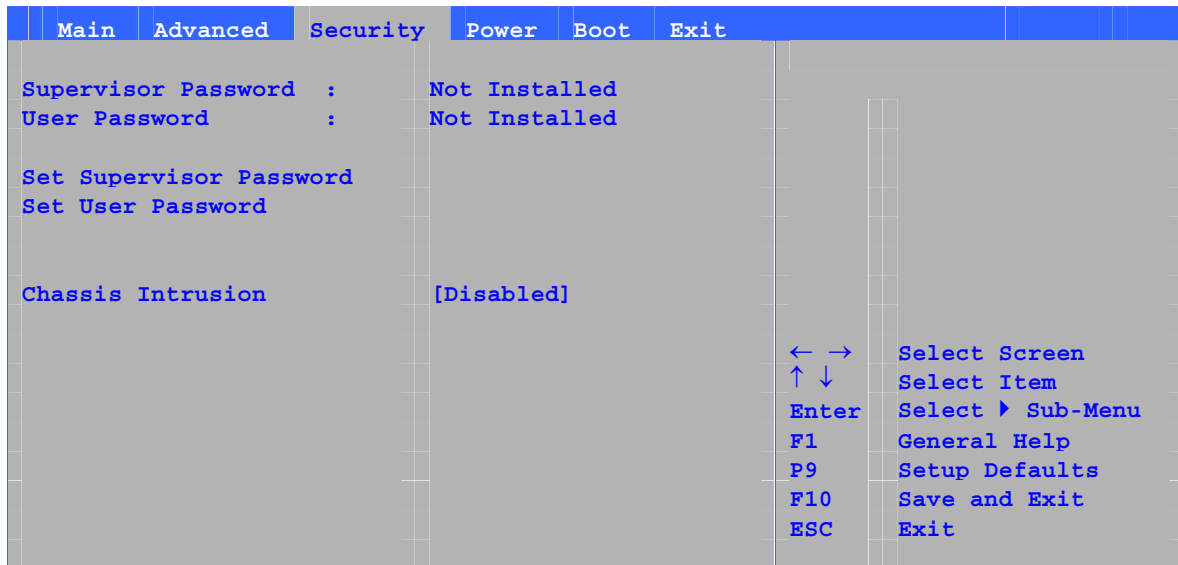

The menu shown in Table 25 is used to set passwords and security features.

**Table 25. Security Menu**

| If no password entered previously: |   |   |
|------------------------------------|---|---|
| Feature                            | Options   | Description   |
| Supervisor Password                | No options  | Reports if there is a supervisor password set.        |
| User Password                      | No options  | Reports if there is a user password set.              |
| Set Supervisor Password            | Password can be up to seven alphanumeric characters.  | Specifies the supervisor password.                    |
| Set User Password                  | Password can be up to seven alphanumeric characters.  | Specifies the user password.                          |
| Clear User Password<br>(Note 1)    | <ul style="list-style-type: none"> <li>• <b>Yes (default)</b></li> <li>• No</li> </ul>  | Clears the user password.                             |
| User access Level<br>(Note 2)      | <ul style="list-style-type: none"> <li>• Limited</li> <li>• No access</li> <li>• View Only</li> <li>• Full (default)</li> </ul> | Sets BIOS Setup Utility access rights for user level. |
| Chassis Intrusion                  | <ul style="list-style-type: none"> <li>• <b>Disabled (default)</b></li> <li>• Enabled</li> </ul>                                | Enables or disables the chassis intrusion feature.    |

Notes:

1. This feature appears only if a user password has been set.
2. This feature appears only if both a user password and a supervisor password have been set.

## Power Menu

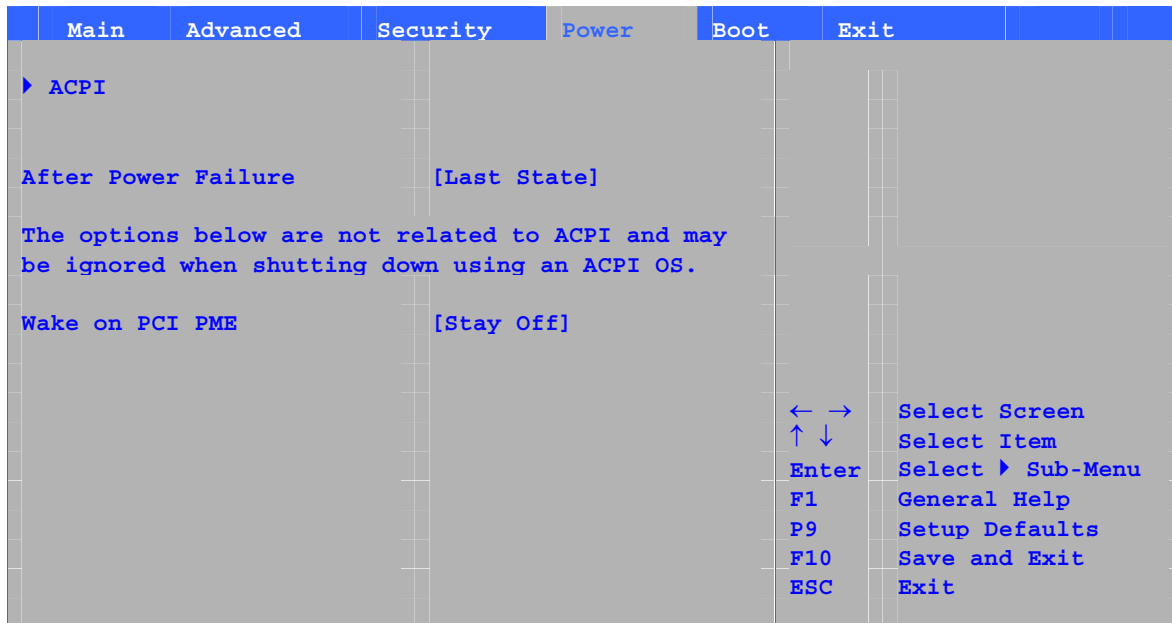

The menu shown in Table 26 is used to set power management features.

**Table 26. Power Menu**

| Feature             | Options   | Description   |
|---------------------|---|---|
| ACPI                | No Options  | When selected, displays the ACPI submenu.   |
| After Power Failure | <ul style="list-style-type: none"> <li>Stay Off</li> <li><b>Last State (default)</b></li> <li>Power On</li> </ul> | <p>Determines the mode of operation if a power loss occurs.</p> <p><i>Stay Off</i> keeps the power off until the power button is pressed.</p> <p><i>Last State</i> restores the previous power state before power loss occurred.</p> <p><i>Power On</i> restores power to the computer.</p> |
| Wake on PCI PME     | <ul style="list-style-type: none"> <li><b>Stay Off (default)</b></li> <li>Power-On</li> </ul>                     | Determines how the system responds to a PCI-PME wake up event.  |

## ACPI Submenu

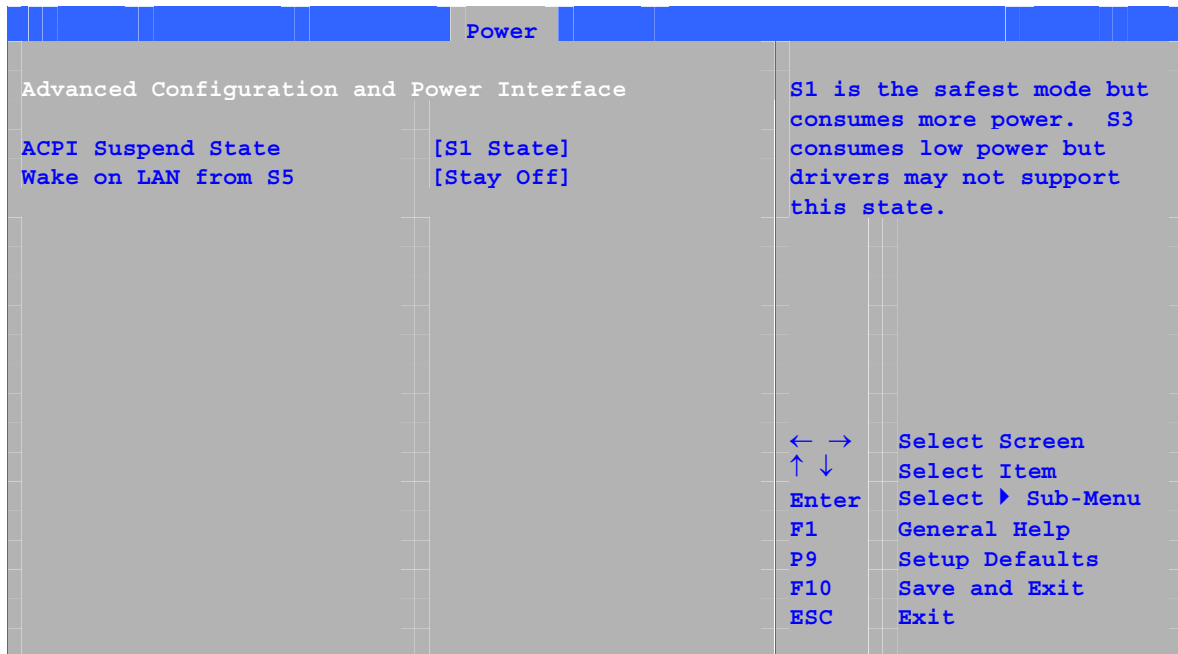

The submenu represented in Table 27 is for setting the ACPI features.

**Table 27. ACPI Submenu**

| Feature              | Options   | Description   |
|----------------------|---|---|
| ACPI Suspend Mode    | <ul style="list-style-type: none"> <li>• <b>S1 State (default)</b></li> <li>• S3 State</li> </ul> | Specifies the ACPI sleep state.   |
| Wake on LAN* from S5 | <ul style="list-style-type: none"> <li>• <b>Stay Off (default)</b></li> <li>• Power On</li> </ul> | In ACPI soft-off mode only, determines how the system responds to a LAN wake up event when the system is in the ACPI soft-off mode. |

## Boot Menu

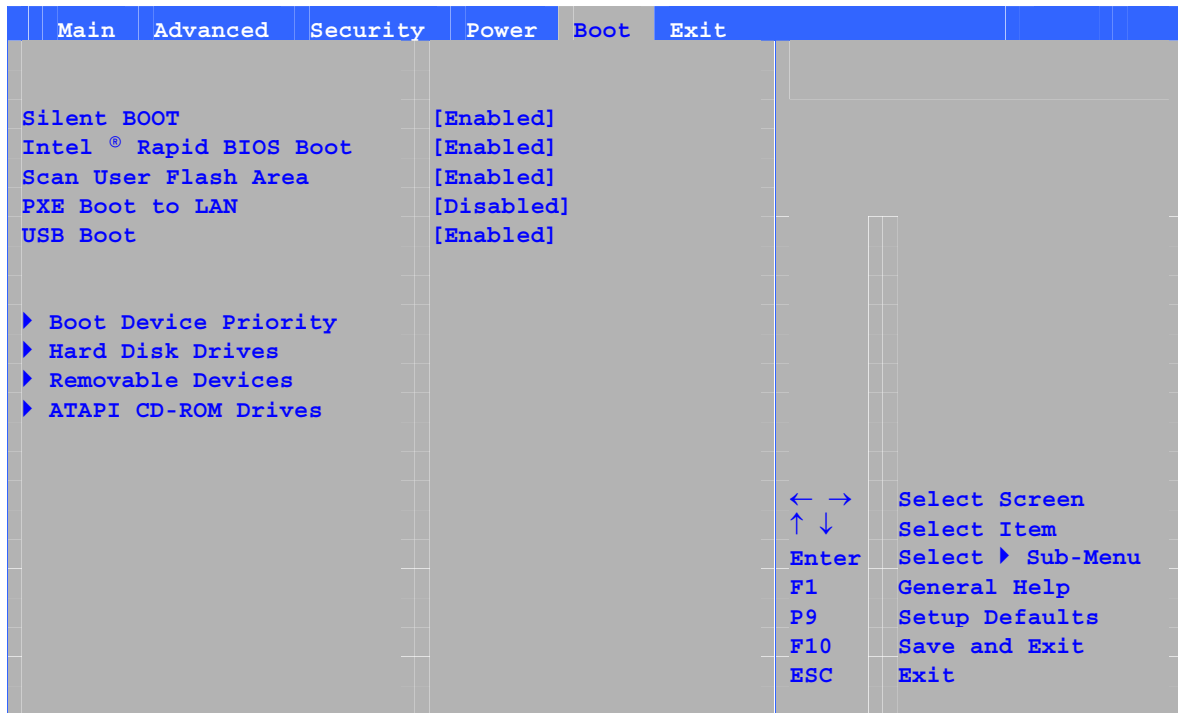

The menu shown in Table 28 is used to set the boot features and the boot sequence.

**Table 28. Boot Menu**

| Feature                | Options  | Description   |
|------------------------|--|---|
| Silent Boot            | <ul style="list-style-type: none"> <li>Disabled</li> <li><b>Enabled (default)</b></li> </ul> | <p><i>Disabled</i> displays normal POST messages.</p> <p><i>Enabled</i> displays OEM logo instead of POST messages.</p> |
| Intel® Rapid BIOS Boot | <ul style="list-style-type: none"> <li>Disabled</li> <li><b>Enabled (default)</b></li> </ul> | Allows BIOS to skip certain tests while booting.  |
| Scan User Flash Area   | <ul style="list-style-type: none"> <li>Disabled</li> <li><b>Enabled (default)</b></li> </ul> | Enables the BIOS to scan the flash ROM for user binary files that are executed at boot time.                            |
| PXE Boot to LAN        | <ul style="list-style-type: none"> <li><b>Disabled (default)</b></li> <li>Enabled</li> </ul> | Disables or enables PXE boot to LAN.  |
| USB Boot               | <ul style="list-style-type: none"> <li>Disabled</li> <li><b>Enabled (default)</b></li> </ul> | Disables or enables booting to USB boot devices.  |
| Boot Device Priority   | No options   | Specifies the boot sequence from the available types of boot devices.   |
| Hard Disk Drives       | No options   | Specifies the boot sequence from the available hard disk drives.  |
| Removable Devices      | No options   | Specifies the boot sequence from the available removable devices.   |
| ATAPI CD-ROM Drives    | No options   | Specifies the boot sequence from the available ATAPI CD-ROM drives.   |



## Boot Device Priority Submenu

| Boot                        |                                |  |
|-----------------------------|--------------------------------|--|
| 1 <sup>st</sup> Boot Device | [1 <sup>st</sup> FLOPPY DRIVE] | Specifies the boot sequence from the available devices.                            |
| 2 <sup>nd</sup> Boot Device | [xxxxxxxxxxx]                  |  |
| 3 <sup>rd</sup> Boot Device | [xxxxxxxxxxx]                  |  |
|                             |                                | A device enclosed in parenthesis has been disabled in the corresponding type menu. |
|                             |                                | ← → Select Screen  |
|                             |                                | ↑ ↓ Select Item  |
|                             |                                | Enter Select ► Sub-Menu  |
|                             |                                | F1 General Help  |
|                             |                                | P9 Setup Defaults  |
|                             |                                | F10 Save and Exit  |
|                             |                                | ESC Exit   |

The submenu represented in Table 29 is for setting boot devices priority.

**Table 29. Boot Device Priority Submenu**

| Feature   | Options  | Description   |
|---|--|---|
| 1 <sup>st</sup> Boot Device<br>2 <sup>nd</sup> Boot Device<br>3 <sup>rd</sup> Boot Device | <ul style="list-style-type: none"> <li>• Removable Device</li> <li>• Hard Drive</li> <li>• ATAPI CD-ROM</li> <li>• Disabled</li> </ul> | <p>Specifies the boot sequence from the available devices. To specify boot sequence:</p> <ol style="list-style-type: none"> <li>1. Select the boot device with &lt;↑&gt; or &lt;↓&gt;.</li> <li>2. Press &lt;Enter&gt; to set the selection as the intended boot device.</li> </ol> <p>The operating system assigns a drive letter to each boot device in the order listed. Changing the order of the devices changes the drive lettering. The default settings for the first through final boot devices are, respectively listed below. The BIOS supports up to sixteen total boot devices in any combination of the boot device types below, with respect to these maximums per type.</p> <ul style="list-style-type: none"> <li>• Removable Device (maximum of four).</li> <li>• Hard Drive (maximum of 12).</li> <li>• ATAPI CD-ROM (maximum of four).</li> <li>• A device enclosed in parenthesis has been disabled in the corresponding type menu.</li> </ul> |

## Hard Disk Drives Submenu

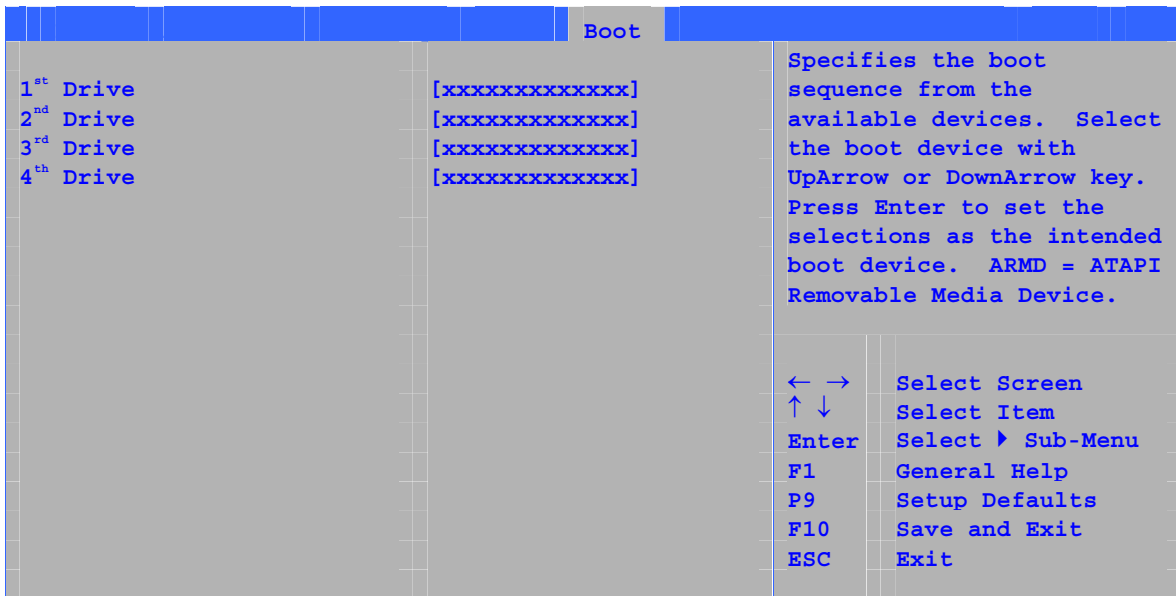

The submenu shown in Table 30 is for setting hard disk drives.

**Table 30. Hard Disk Drives Submenu**

| Feature                                   | Options                            | Description  |
|---|------------------------------------|--|
| 1 <sup>st</sup> Hard Disk Drive<br>(Note) | Dependent on installed hard drives | Specifies the boot sequence from the available hard disk drives. To specify boot sequence:<br>1. Select the boot device with <↑> or <↓>.<br>2. Press <Enter> to set the selection as the intended boot device. |

Note: This boot device submenu appears only if at least one boot device of this type is installed. This list will display up to 12 hard disk drives, the maximum number of hard disk drives supported by the BIOS.

## Removable Devices Submenu

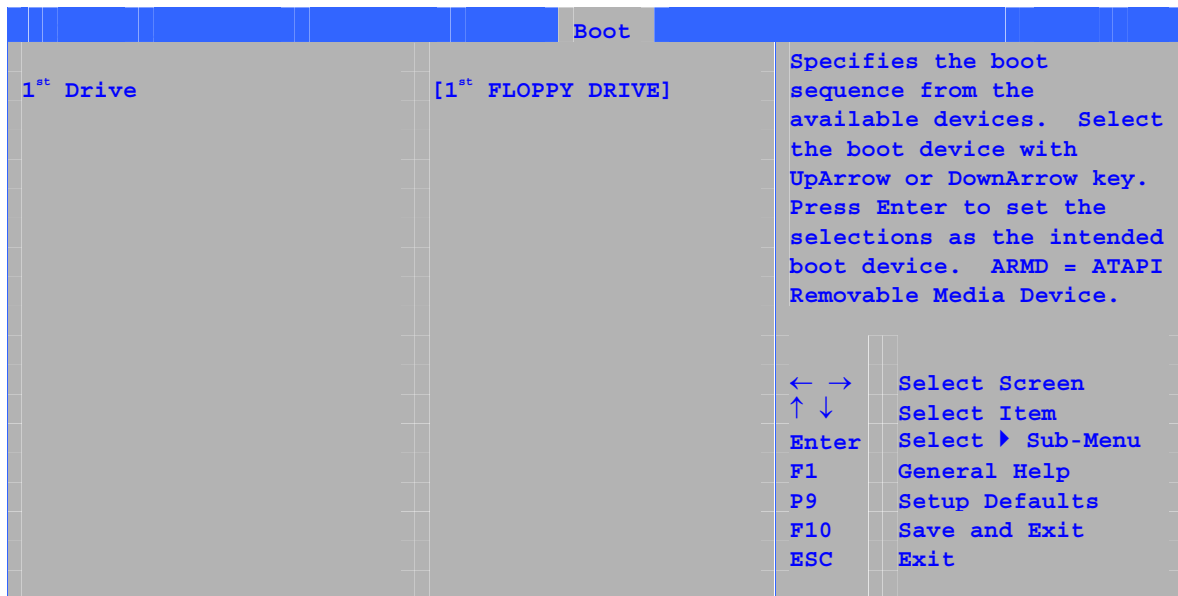

The submenu in shown Table 31 is for setting removable devices.

**Table 31. Removable Devices Submenu**

| Feature                                    | Options                                  | Description  |
|--|--|--|
| 1 <sup>st</sup> Removable Device<br>(Note) | Dependent on installed removable devices | Specifies the boot sequence from the available removable devices. To specify boot sequence: <ol style="list-style-type: none"> <li>Select the boot device with &lt;↑&gt; or &lt;↓&gt;.</li> <li>Press &lt;Enter&gt; to set the selection as the intended boot device.</li> </ol> |

Note: This boot device submenu appears only if at least one boot device of this type is installed. This list will display up to four removable devices, the maximum number of removable devices supported by the BIOS.

## ATAPI CD-ROM Drives

|                       |          | Boot |   |
|-----------------------|----------|------|---|
| 1 <sup>st</sup> Drive | [xxxxxx] |      | Specifies the boot sequence from the available devices. Select the boot device with UpArrow or DownArrow key. Press Enter to set the selections as the intended boot device. ARMD = ATAPI Removable Media Device. |
| 2 <sup>nd</sup> Drive | [xxxxxx] |      |   |
|                       |          |      | ← → Select Screen<br>↑ ↓ Select Item<br>Enter Select ▶ Sub-Menu<br>F1 General Help<br>P9 Setup Defaults<br>F10 Save and Exit<br>ESC Exit  |

The submenu shown in Table 32 is for setting ATAPI CD-ROM drives.

**Table 32. ATAPI CD-ROM Drives Submenu**

| Feature                                      | Options                                    | Description  |
|--|--|--|
| 1 <sup>st</sup> ATAPI CD-ROM Drive<br>(Note) | Dependent on installed ATAPI CD-ROM drives | Specifies the boot sequence from the available ATAPI CD-ROM drives. To specify boot sequence: <ol style="list-style-type: none"> <li>1. Select the boot device with &lt;↑&gt; or &lt;↓&gt;.</li> <li>2. Press &lt;Enter&gt; to set the selection as the intended boot device.</li> </ol> |

Note: This boot device submenu appears only if at least one boot device of this type is installed. This list will display up to four ATAPI CD-ROM drives, the maximum number of ATAPI CD-ROM drives supported by the BIOS.

## Exit Menu

| Main  | Advanced | Security | Power | Boot | Exit |
|---|----------|----------|-------|------|------|
| Exit Saving Changes<br>Exit Discarding Changes<br>Load Optimal Defaults<br>Load Custom Defaults<br>Save Custom Defaults<br>Discard Changes                                  |          |          |       |      |      |
| ← →    Select Screen<br>↑ ↓    Select Item<br>Enter    Select ► Sub-Menu<br>F1        General Help<br>P9        Setup Defaults<br>F10       Save and Exit<br>ESC       Exit |          |          |       |      |      |

The menu shown in Table 33 is used to exit the BIOS Setup program, saving changes, and loading and saving defaults.

**Table 33. Exit Menu**

| Feature                 | Description  |
|-------------------------|--|
| Exit Saving Changes     | Exits and saves the changes in CMOS SRAM.  |
| Exit Discarding Changes | Exits without saving any changes made in the BIOS Setup program.   |
| Load Optimal Defaults   | Loads optimal defaults.  |
| Load Custom Defaults    | Loads the custom defaults for Setup options.   |
| Save Custom Defaults    | Saves the current values as custom defaults. Normally, the BIOS reads the Setup values from flash memory. If this memory is corrupted, the BIOS reads the custom defaults. If no custom defaults are set, the BIOS reads the factory defaults. |
| Discard Changes         | Discards changes without exiting Setup. The option values present when the computer was turned on are used.  |



# 5 Desktop Board Resources

## Memory Map

**Table 34. System Memory Map**

| Address Range (decimal) | Address Range (hex) | Size    | Description   |
|-------------------------|---------------------|---------|---|
| 1024 K - 2097152 K      | 100000 - 7FFFFFFF   | 2047 MB | Extended Memory   |
| 960 K - 1024 K          | F0000 - FFFFF       | 64 KB   | Runtime BIOS  |
| 896 K - 960 K           | E0000 - EFFFF       | 64 KB   | Reserved  |
| 800 K - 896 K           | C8000 - DFFFF       | 96 KB   | Available high DOS memory (open to the PCI bus)         |
| 640 K - 800 K           | A0000 - C7FFF       | 160 KB  | Video memory and BIOS                                   |
| 639 K - 640 K           | 9FC00 - 9FFFF       | 1 KB    | Extended BIOS data (movable by memory manager software) |
| 512 K - 639 K           | 80000 - 9FBFF       | 127 KB  | Extended conventional memory                            |
| 0 K - 512 K             | 00000 - 7FFFF       | 512 KB  | Conventional memory                                     |

## DMA Channels

**Table 35. DMA Channels**

| DMA Channel Number | Data Width   | System Resource                |
|--------------------|--------------|--------------------------------|
| 0                  | 8 or 16 bits |                                |
| 1                  | 8 or 16 bits | Parallel port                  |
| 2                  | 8 or 16 bits | Floppy drive                   |
| 3                  | 8 or 16 bits | Parallel port (for ECP or EPP) |
| 4                  | 8 or 16 bits | DMA controller                 |
| 5                  | 16 bits      | Open                           |
| 6                  | 16 bits      | Open                           |
| 7                  | 16 bits      | Open                           |

## Interrupts

**Table 36. Interrupts**

| IRQ | System Resource                                      |
|-----|--|
| NMI | I/O channel check                                    |
| 0   | Reserved, interval timer                             |
| 1   | Reserved, keyboard buffer full                       |
| 2   | Reserved, cascade interrupt from slave PIC           |
| 3   | COM2*  |
| 4   | COM1*  |
| 5   | LPT2 (Plug and Play option) **                       |
| 6   | Floppy drive controller                              |
| 7   | LPT1*  |
| 8   | Real time clock                                      |
| 9   | **   |
| 10  | **   |
| 11  | **   |
| 12  | Onboard mouse port (if present, else user available) |
| 13  | Reserved, math coprocessor                           |
| 14  | Primary IDE (if present, else user available)        |
| 15  | Secondary IDE (if present, else user available)      |

\* Default, but can be changed to another IRQ.

\*\* Dynamically allocated for all PCI/AGP devices and slots.



# A Error Messages and Indicators

---

Desktop Board D865PCD reports POST errors in two ways:

- By sounding a beep code
- By displaying an error message on the monitor

## BIOS Beep Codes

The BIOS beep codes are listed in Table 37. The BIOS also issues a beep code (one long tone followed by two short tones) during POST if the video configuration fails (a faulty video card or no card installed) or if an external ROM module does not properly checksum to zero.

**Table 37. Beep Codes**

| Number of Beeps | Description  |
|-----------------|--|
| 1               | Refresh failure  |
| 2               | Parity cannot be reset   |
| 3               | First 64 K memory failure                                      |
| 4               | Timer not operational  |
| 5               | Processor failure (Reserved; not used)                         |
| 6               | 8042 GateA20 cannot be toggled (memory failure or not present) |
| 7               | Exception interrupt error                                      |
| 8               | Display memory R/W error                                       |
| 9               | (Reserved; not used)   |
| 10              | CMOS Shutdown register test error                              |
| 11              | Invalid BIOS (such as, POST module not found)                  |

## BIOS Error Messages

When a recoverable error occurs during the POST, the BIOS displays an error message describing the problem.

**Table 38. BIOS Error Messages**

| Error Message  | Explanation   |
|--|---|
| GA20 Error   | An error occurred with Gate-A20 when switching to protected mode during the memory test.                          |
| Pri Master HDD Error<br>Pri Slave HDD Error<br>Sec Master HDD Error<br>Sec Slave HDD Error   | Could not read sector from corresponding drive.   |
| Pri Master Drive - ATAPI Incompatible<br>Pri Slave Drive - ATAPI Incompatible<br>Sec Master Drive - ATAPI Incompatible<br>Sec Slave Drive - ATAPI Incompatible | Corresponding drive is not an ATAPI device. Run Setup to make sure device is selected correctly.                  |
| A: Drive Error<br>B: Drive Error   | No response from the diskette drive.  |
| CMOS Battery Low   | The battery may be losing power. Replace the battery soon.  |
| CMOS Display Type Wrong  | The display type is different than what has been stored in CMOS. Check Setup to make sure type is correct.        |
| CMOS Checksum Bad  | The CMOS checksum is incorrect. CMOS memory may have been corrupted. Run Setup to reset values.                   |
| CMOS Settings Wrong  | CMOS values are not the same as the last boot. These values have either been corrupted or the battery has failed. |
| CMOS Date/Time Not Set   | The time and/or date values stored in CMOS are invalid. Run Setup to set correct values.                          |
| DMA Error  | Error during read/write test of DMA controller.   |
| FDC Failure  | Error occurred trying to access diskette drive controller.  |
| HDC Failure  | Error occurred trying to access hard disk controller.   |
| Checking NVRAM.....  | NVRAM is being checked to see if it is valid.   |
| Update OK!   | NVRAM was invalid and has been updated.   |
| Updated Failed   | NVRAM was invalid but was unable to be updated.   |
| Keyboard Is Locked   | The system keyboard lock is engaged. The system must be unlocked to continue to boot.                             |
| Keyboard Error   | Error in the keyboard connection. Make sure keyboard is connected properly.                                       |
| KB/Interface Error   | Keyboard interface test failed.   |

continued

**Table 38. BIOS Error Messages** (continued)

| <b>Error Message</b>                      | <b>Explanation</b>   |
|---|--|
| Memory Size Decreased                     | Memory size has decreased since the last boot. If no memory was removed, then memory may be bad.               |
| Memory Size Increased                     | Memory size has increased since the last boot. If no memory was added, there may be a problem with the system. |
| Memory Size Changed                       | Memory size has changed since the last boot. If no memory was added or removed, then memory may be bad.        |
| No Boot Device Available                  | System did not find a device to boot.  |
| Off Board Parity Error                    | A parity error occurred on an offboard card. This error is followed by an address.                             |
| On Board Parity Error                     | A parity error occurred in onboard memory. This error is followed by an address.                               |
| Parity Error                              | A parity error occurred in onboard memory at an unknown address.   |
| NVRAM / CMOS / PASSWORD cleared by Jumper | NVRAM, CMOS, and passwords have been cleared. The system should be powered down and the jumper removed.        |
| <CTRL_N> Pressed                          | CMOS is ignored and NVRAM is cleared. User must enter Setup.   |



## B Regulatory Compliance

---

This appendix contains the following regulatory compliance information for Desktop Board D865PCD:

- Safety regulations
- European Union Declaration of Conformity statement
- Product Ecology statements
- Electromagnetic Compatibility (EMC) regulations
- Product certification markings

### Safety Regulations

Desktop Board D865PCD complies with the safety regulations stated in Table 39 when correctly installed in a compatible host system.

**Table 39. Safety Regulations**

| Regulation                                   | Title   |
|--|---|
| UL 60950-1:2003/<br>CSA C22.2 No. 60950-1-03 | Information Technology Equipment – Safety - Part 1: General Requirements (USA and Canada) |
| EN 60950-1:2002                              | Information Technology Equipment – Safety - Part 1: General Requirements (European Union) |
| IEC 60950-1:2001, First Edition              | Information Technology Equipment – Safety - Part 1: General Requirements (International)  |

### European Union Declaration of Conformity Statement

We, Intel Corporation, declare under our sole responsibility that the product Intel® Desktop Board D865PCD is in conformity with all applicable essential requirements necessary for CE marking, following the provisions of the European Council Directive 89/336/EEC (EMC Directive) and Council Directive 73/23/EEC (Safety/Low Voltage Directive).

The product is properly CE marked demonstrating this conformity and is for distribution within all member states of the EU with no restrictions.



This product follows the provisions of the European Directives 89/336/EEC and 73/23/EEC.

*Dansk* Dette produkt er i overensstemmelse med det europæiske direktiv 89/336/EEC & 73/23/EEC.

*Dutch* Dit product is in navolging van de bepalingen van Europees Directief 89/336/EEC & 73/23/EEC.

*Suomi* Tämä tuote noudattaa EU-direktiivin 89/336/EEC & 73/23/EEC määräyksiä.

*Français* Ce produit est conforme aux exigences de la Directive Européenne 89/336/EEC & 73/23/EEC.

*Deutsch* Dieses Produkt entspricht den Bestimmungen der Europäischen Richtlinie 89/336/EEC & 73/23/EEC.

*Icelandic* Þessi vara stenst reglugerð Evrópska Efnahags Bandalagsins númer 89/336/EEC & 73/23/EEC.

*Italiano* Questo prodotto è conforme alla Direttiva Europea 89/336/EEC & 73/23/EEC.

*Norsk* Dette produktet er i henhold til bestemmelsene i det europeiske direktivet 89/336/EEC & 73/23/EEC.

*Portuguese* Este produto cumpre com as normas da Diretiva Europeia 89/336/EEC & 73/23/EEC.

*Español* Este producto cumple con las normas del Directivo Europeo 89/336/EEC & 73/23/EEC.

*Svenska* Denna produkt har tillverkats i enlighet med EG-direktiv 89/336/EEC & 73/23/EEC.

## Product Ecology Statements

The following information is provided to address worldwide product ecology concerns and regulations.

### Disposal Considerations

This product contains the following materials that may be regulated upon disposal: lead solder on the printed wiring board assembly.

### Recycling Considerations

Intel encourages its customers to recycle its products and their components (e.g., batteries, circuit boards, plastic enclosures, etc.) whenever possible. In the U.S., a list of recyclers in your area can be found at:

<http://www.eiae.org>

In the absence of a viable recycling option, products and their components must be disposed of in accordance with all applicable local environmental regulations.

## EMC Regulations

Desktop Board D865PCD complies with the EMC regulations stated in Table 40 when correctly installed in a compatible host system.

**Table 40. EMC Regulations**

| Regulation                                   | Title   |
|--|---|
| FCC Class B                                  | Title 47 of the Code of Federal Regulations, Parts 2 and 15, Subpart B, Radio Frequency Devices. (USA)                        |
| ICES-003 (Class B)                           | Interference-Causing Equipment Standard, Digital Apparatus. (Canada)  |
| EN55022: 1998 (Class B)                      | Limits and methods of measurement of Radio Interference Characteristics of Information Technology Equipment. (European Union) |
| EN55024: 1998                                | Information Technology Equipment – Immunity Characteristics Limits and methods of measurement. (European Union)               |
| AS/NZS 3548 (Class B)                        | Australian Communications Authority, Standard for Electromagnetic Compatibility. (Australia and New Zealand)                  |
| CISPR 22, 3 <sup>rd</sup> Edition, (Class B) | Limits and methods of measurement of Radio Disturbance Characteristics of Information Technology Equipment. (International)   |
| CISPR 24: 1997                               | Information Technology Equipment – Immunity Characteristics – Limits and Methods of Measurement. (International)              |
| VCCI (Class B)                               | Voluntary Control for Interference by Information Technology Equipment (Japan)  |

Japanese Kanji statement translation: This is a Class B product based on the standard of the Voluntary Control Council for Interference from Information Technology Equipment (VCCI). If this is used near a radio or television receiver in a domestic environment, it may cause radio interference. Install and use the equipment according to the instruction manual.

この装置は、情報処理装置等電波障害自主規制協議会（VCCI）の基準に基づくクラスB情報技術装置です。この装置は、家庭環境で使用することを目的としていますが、この装置がラジオやテレビジョン受信機に近接して使用されると、受信障害を引き起こすことがあります。  
取扱説明書に従って正しい取り扱いをして下さい。



Korean Class B statement translation: This is household equipment that is certified to comply with EMC requirements. You may use this equipment in residential environments and other non-residential environments.

이 기기는 가정용으로 전자파적합등록을 한 기기로서 주거지역에서는 물론 모든 지역에서 사용할 수 있습니다.

## Product Certification Markings (Board Level)

Desktop Board D865PCD has the following product certification markings:

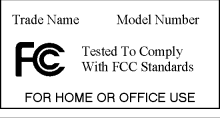
**Table 41. Product Certification Markings**

| Description  | Mark  |
|--|---|
| UL joint US/Canada Recognized Component mark. Includes adjacent UL file number for Intel desktop boards: E210882 (component side).   |  |
| FCC Declaration of Conformity logo mark for Class B equipment; includes Intel name and D865PCD model designation (component side).   |  |
| CE mark. Declares compliance to European Union (EU) EMC directive (89/336/EEC) and Low Voltage directive (73/23/EEC) (component side). The CE mark should also be on the shipping container. |  |
| Australian Communications Authority (ACA) C-tick mark. Includes adjacent Intel supplier code number, N-232. The C-tick mark should also be on the shipping container.                        |  |
| Printed wiring board manufacturer's recognition mark: consists of a unique UL recognized manufacturer's logo, along with a flammability rating (solder side).                                | V-0 or 94V-0  |