



Intel® Server Board S2600COE

Intel® Server Board S2600CO4

Intel® Server Chassis P4000M Family

Spares/Accessories List and Configuration Guide

A reference guide to assist customers in ordering the necessary components to configure the Intel® Server Board S2600COE, Intel® Server Board S2600CO4, with appropriate Intel chassis.



Revision 1.8

Aug 2013

Enterprise Platforms and Services Marketing



Revision History

Nov '11	Rev 0.55	Initial draft release for internal reviews
Nov '11	Rev 0.8	Updated with team feedbacks
Jan '12	Rev 0.9	Added new 6G bundled SKU
Jan '12	Rev 1.0	Updated pictures, ordering details, descriptions.
Jan '12	Rev 1.1	Removed all NA SKUs, final revision for book open.
Feb '12	Rev 1.2	Updated description for AXXRSBBU9; updated entire section of VMware and Symantec
May '12	Rev 1.3	Updated description details
July '12	Rev 1.4	Clarified that support for Intel® SAS and RAID modules is in PCIe form factor. Modules are sold separately; clarified power cable extension for connecting 24-pin power cable to S2600CO board for use in P4000M chassis is included in air duct kit
July 24 '12	Rev 1.5	Add Intel® Server Continuity Suite order information
Dec '12	Rev. 1.6	Removed VMware, Symantec, Intel® Server Continuity Suite, and Intel® Onsite Repair for Servers SKUs. Updated description details
July'13	Rev 1.7	Update MM#s.
Aug'13	Rev 1.8	Added E5-2600 v2 processor support.

INFORMATION IN THIS DOCUMENT IS PROVIDED IN CONNECTION WITH INTEL® PRODUCTS. NO LICENSE, EXPRESS OR IMPLIED, BY ESTOPPEL OR OTHERWISE, TO ANY INTELLECTUAL PROPERTY RIGHTS IS GRANTED BY THIS DOCUMENT. EXCEPT AS PROVIDED IN INTEL'S TERMS AND CONDITIONS OF SALE FOR SUCH PRODUCTS, INTEL ASSUMES NO LIABILITY WHATSOEVER, AND INTEL DISCLAIMS ANY EXPRESS OR IMPLIED WARRANTY, RELATING TO SALE AND/OR USE OF INTEL PRODUCTS INCLUDING LIABILITY OR WARRANTIES RELATING TO FITNESS FOR A PARTICULAR PURPOSE, MERCHANTABILITY, OR INFRINGEMENT OF ANY PATENT, COPYRIGHT OR OTHER INTELLECTUAL PROPERTY RIGHT.

Intel products are not intended for use in medical, life saving, life sustaining applications. Intel may make changes to specifications and product descriptions at any time, without notice.

Intel server boards, server chassis, and processors may contain design defects or errors known as errata, which may cause the product to deviate from published specifications. Current characterized errata are available on request.

Intel, Intel Xeon, Pentium, and the Intel logo are trademarks or registered trademarks of Intel Corporation or its subsidiaries in the United States and other countries.

*Other names and brands may be claimed as the property of others.

Copyright © 2013, Intel Corporation



Table of Contents:

- 1. SYSTEM PRODUCT ORDER CODES 5**
 - 1.1 PRODUCT DESCRIPTIONS – OVERVIEW 5
 - 1.2 AVAILABLE PRODUCTION BOARD ORDER CODE 5
 - 1.3 AVAILABLE PRODUCTION CHASSIS ORDER CODES..... 8

- 2. SPARES AND ACCESSORIES ORDER CODES 16**
 - 2.1 GENERAL SPARES AND ACCESSORIES 16
 - 2.2 POWER SUB-SYSTEM SPARES 20
 - 2.3 DRIVE/STORAGE SUBSYSTEM SPARES AND ACCESSORIES..... 21
 - 2.4 EXPANSION MODULES: IO MODULE, SAS MODULE, RMM4, TPM 23

1. System Product Order Codes

1.1 Product Descriptions – Overview

Intel® Server Board S2600COE and S2600CO4 are enterprise class server boards designed to provide maximum I/O flexibility, expandability and manageability.



- 1) S2600COE will be offered in both OEM and retail package
- 2) S2600CO4 will be offered in OEM package only

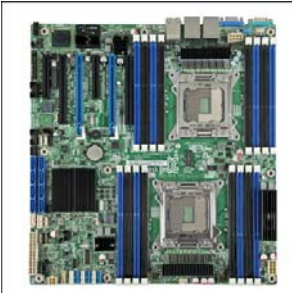

Both boards are compatible and validated in the latest Intel® Server Chassis P4000M family. For detailed ordering information such as MM numbers and product order codes, please refer to below sections in this document.

1.2 Available Production Board Order Code

Not included in package: Processors, memory DIMMs, heat sinks, and other customer configuration items are not included in below board SKUs.

Image	Product Code MM UPC EAN MOQ	Description
	<p>DBS2600COE 918728 00735858239981 5032037034722 5</p>	<p>Boxed Intel Server Board S2600COE, Retail Single Pack</p> <ul style="list-style-type: none"> • Supports Dual Intel Xeon E5-2600 and E5-2600 v2 processors up to 150W • Intel® C600 series chipset • 16 DDR3/DDR3L DIMM slots • 6 PCIe slots • 8 SCU SATA/SAS ports <ul style="list-style-type: none"> ○ 4 SATA ports functional w/ no storage keys and 4 ports require storage keys ○ SAS function requires storage key activation • 2 SATA 6G AHCI ports • Integrated Intel® Quad Gigabit Ethernet Ports with Intel Virtualization Technology • Integrated Baseboard Management Controller with IPMI 2.0 • Option for advanced management functions with KVM and dedicated NIC for remote management • Support for Intel® SAS and RAID modules in PCIe form factor. Modules sold separately. • 1394b down with dual ports <p>Includes I/O shield, cables, configuration labels, Intel® Server Deployment & Management DVD, attention document, Quick Start User's Guide</p>



	<p>BBS2600COE 918727 00735858239998 5032037034739 10</p>	<p>Intel Server Board S2600COE, OEM 10-Pack</p> <ul style="list-style-type: none"> • Supports Dual Intel Xeon E5-2600 and E5-2600 v2 processors up to 150W • Intel® C600 series chipset • 16 DDR3/DDR3L DIMM slots • 6 PCIe slots • 8 SCU SATA/SAS ports <ul style="list-style-type: none"> ◦ 4 SATA ports functional w/ no storage keys and 4 ports require storage keys ◦ SAS function requires storage key activation • 2 SATA 6G AHCI ports • Integrated Intel® Quad Gigabit Ethernet Ports with Intel Virtualization Technology • Integrated Baseboard Management Controller with IPMI 2.0 • Option for advanced management functions with KVM and dedicated NIC for remote management • Support for Intel® SAS and RAID modules in PCIe form factor. Modules sold separately. • 1394b down with dual ports <p>Does not include I/O shield, cables, configuration labels, Intel® Server Deployment & Management DVD and Quick Start User's Guide.</p> <p>Attention document is included.</p>
	<p>BBS2600CO4 916033 00735858240000 5032037034746 10</p>	<p>Intel Server Board S2600CO4, OEM 10-Pack</p> <ul style="list-style-type: none"> • Supports Dual Intel Xeon E5-2600 and E5-2600 v2 processors up to 135W • Intel® C600 series chipset • 16 DDR3/DDR3L DIMM slots • 6 PCIe slots • 8 SCU SATA/SAS ports <ul style="list-style-type: none"> ◦ 4 SATA ports functional w/ no storage keys and 4 ports require storage keys ◦ SAS function requires storage key activation • 2 SATA 6G AHCI ports • Integrated Intel® Quad Gigabit Ethernet Ports with Intel Virtualization Technology • Integrated Baseboard Management Controller with IPMI 2.0 • Option for advanced management functions with KVM and dedicated NIC for remote management • Support for Intel® SAS and RAID modules in PCIe form factor. Modules sold separately. <p>Does not include I/O shield, cables, configuration labels, Intel® Server Deployment & Management DVD and Quick Start User's Guide.</p> <p>Attention document is included.</p>



 <p style="text-align: center;">And</p> 	<p style="text-align: center;">DBS2600COEIO C 920973 00735858244497 5032037039062 5</p>	<p>Boxed Intel Server Board S2600COE bundled with 8-port SAS IOC card, Retail Single Pack</p> <ul style="list-style-type: none"> • Supports Dual Intel Xeon E5-2600 and E5-2600 v2 processors up to 150W • Intel® C600 series chipset • 16 DDR3/DDR3L DIMM slots • 6 PCIe slots • 8 SCU SATA/SAS ports <ul style="list-style-type: none"> ○ 4 SATA ports functional w/ no storage keys and 4 ports require storage keys ○ SAS function requires storage key activation • 2 SATA 6G AHCI ports • Integrated Intel® Quad Gigabit Ethernet Ports with Intel Virtualization Technology • Integrated Baseboard Management Controller with IPMI 2.0 • Option for advanced management functions with KVM and dedicated NIC for remote management • Support for Intel® SAS and RAID modules in PCIe form factor. Modules sold separately. • 1394b down with dual ports <p>Includes I/O shield, cables, configuration labels, Intel® Server Deployment & Management DVD, attention document, Quick Start User's Guide, Intel® Integrated RAID Module RMS25KB080, 2 module support brackets (low profile and full height), screws.</p> <p>Note: Cables for SAS module sold separately:</p> <ul style="list-style-type: none"> • If using <u>hot-swap</u> disk drives, 2 mini-SAS to mini-SAS cables are required. See product code AXXCBL650MSMS. • If using <u>fixed</u> disk drives, 2 SAS cables are required. See Product code AXXCBL850MS7R.
--	---	---





1.3 Available Production Chassis Order Codes



Not included in chassis: Air Duct, **Rail Kits**, heat sinks, processors, memory DIMMs, hard drives, and other customer configuration items are not included in below chassis SKUs.



Note: EPSD Romley Chassis and Systems shipped to the US & Canada will contain North American power cords. North American customers no longer need to order skus ending in "NA" to receive power cords on Romley products.



Image	Product Code MM UPC EAN MOQ	Description
	P4208XXMHGC 916310 00735858235723 5032037030472 1	<p>A general purpose pedestal chassis targeted at small to medium business supporting CEB and EEB form factor server boards with 2.5" Hot-Swap HDDs, 750W Cold-Redundant Power Supplies and Redundant Cooling</p> <p>Includes: 8x 2.5" Hot-Swap Drive Carriers, 2x 750W Common Redundant Power Supply (Platinum Efficiency), 5x 80mm hot-swap fans, , one 480mm miniSAS cable with one vertical miniSAS header and four vertical SATA headers, one 100mm HotSwapBackPlane power cable with one 4-pin ATX power header and one 2x2 header.</p> <p>Note: This chassis is compatible with multiple server board skus. As such the specific airduct and cables for that server board needs to be ordered seperately. This chassis does not have any airduct. AUPMGPURBR(920613) needs to be ordered to support add-in GPGPU cards.</p>
	P4208XXMHGR 916312 00735858235747 5032037030496 1	<p>A general purpose pedestal chassis targeted at small to medium business supporting CEB and EEB form factor server boards with 2.5" Hot-Swap HDDs, 750W Cold-Redundant Power Supplies and non-Redundant Cooling</p> <p>Includes: 8x 2.5" Hot-Swap Drive Carriers, 2x 750W Common Redundant Power Supply (Platinum Efficiency), 2x 120mm fixed fans, one 480mm miniSAS cable with one vertical miniSAS header and 4 vertical SATA headers, one 100mm HotSwapBackPlane power cable with one 4-pin ATX power header and one 2x2 header.</p> <p>Note: This chassis is compatible with multiple server board skus. As such the specific airduct and cables for that server board needs to be ordered seperately. This chassis does not have any airduct. AUPMGPURBR(920613) needs to be ordered to support add-in GPGPU cards.</p>



	<p>P4308XXMHGC 916320 00735858235693 5032037030441 1</p>	<p>A general purpose pedestal chassis targeted at small to medium business supporting CEB and EEB form factor server boards with 3.5" Hot-Swap HDDs, 750W Cold-Redundant Power Supplies and Redundant Cooling</p> <p>Includes: 8x 3.5" Hot-Swap Drive Carriers, 2x 750W Common Redundant Power Supply (Platinum Efficiency), 5x 80mm hot-swap fans, one 480mm miniSAS cable with one vertical miniSAS header and 4 vertical SATA headers, one 100mm HotSwapBackPlane power cable with one 4-pin ATX power header and one 2x2 header.</p> <p>Note: This chassis is compatible with multiple server board skus. As such the specific airduct and cables for that server board needs to be ordered seperately. This chassis does not have any airduct. AUPMGPURBR(920613) needs to be ordered to support add-in GPGPU cards</p>
	<p>P4308XXMFGN 916330 00735858235679 5032037030427 1</p>	<p>A general purpose pedestal chassis targeted at small to medium business supporting CEB and EEB form factor server boards with 3.5" Fixed HDDs, 1x 750W Redundant-capable Power Supplies and non-Redundant Cooling</p> <p>Includes: 8x 3.5" Fixed Drive Carriers, 750W Redundant-capable Power Supply (Platinum Efficiency), 2x 120mm fixed fans, two 150mm SATA power cables with one 4-pin ATX power header and 2 vertical SATA power headers, four 600mm SATA cables , each cable has one vertical SATA header and one right angle SATA header.</p> <p>Note: This chassis is compatible with multiple server board skus. As such the specific airduct and cables for that server board needs to be ordered seperately. This chassis does not have any airduct. AUPMGPURBR(920613) needs to be ordered to support add-in GPGPU cards</p>
	<p>P4308XXMHEN 916335 00735858235655 5032037030403 1</p>	<p>A general purpose pedestal chassis targeted at small to medium business supporting CEB and EEB form factor server boards with 3.5" Hot-Swap HDDs, 1x 550W Fixed Power Supplies and non-Redundant Cooling</p> <p>Includes: 8x 3.5" Hot-Swap Drive Carriers, 550W Fixed Power Supply (Silver Efficiency), 2x 120mm fixed fans, one 480mm miniSAS cable with one vertical miniSAS header and 4 vertical SATA headers, one 100mm HotSwapBackPlane power cable with one 4-pin ATX power header and one 2x2 header.</p> <p>Note: This chassis is compatible with multiple server board skus. As such the specific airduct and cables for that server board needs to be ordered seperately. This chassis does not have any airduct. AUPMGPURBR(920613) needs to be ordered to support add-in GPGPU cards</p>



	<p>P4308XXMFEN 916337 00735858235631 5032037030380 1</p>	<p>A general purpose pedestal chassis targeted at small to medium business supporting CEB and EEB form factor server boards with 3.5" Fixed HDDs, 1x 550W Fixed Power Supplies and non-Redundant Cooling</p> <p>Includes: 8x 3.5" Fixed Drive Carriers, 550W Fixed Power Supply (Silver Efficiency), 2x 120mm fixed fans</p> <p>Note: This chassis is compatible with multiple server board skus. As such the specific airduct for that server board needs to be ordered seperately.</p>
	<p>P4208XXMHDR 916313 00735858235754 5032037030502 1</p>	<p>A general purpose pedestal chassis targeted at small to medium business supporting CEB and EEB form factor server boards with 2.5" Hot Swap HDDs, 460W Redundant Power Supplies and non-Redundant Cooling</p> <p>Includes: 8 x 2.5" Hot Swap Drive Carriers, , 460W Redundant Power Supplies (Gold Efficiency), 2x 120mm fixed fans</p> <p>Note: This chassis is compatible with multiple server board skus. As such the specific airduct for that server board needs to be ordered seperately.</p>
	<p>P4208XXMHEN 916315 00735858235778 5032037030526 1</p>	<p>A general purpose pedestal chassis targeted at small to medium business supporting CEB and EEB form factor server boards with 2.5" Hot Swap HDDs, 550W Fixed Power Supply and non-Redundant Cooling</p> <p>Includes: 8 x 2.5" Hot Swap Drive Carriers, 550W Fixed non-redundant Power Supply (Silver Efficiency), 2x 120mm fixed fans, two 150mm SATA power cables with one 4-pin ATX power header and 2 vertical SATA power headers, four 600mm SATA cables , each cable has one vertical SATA header and one right angle SATA header.</p> <p>Note: This chassis is compatible with multiple server board skus. As such the specific airduct and cables for that server board needs to be ordered seperately. This chassis does not have any airduct.</p> <p>AUPMGPURBR(920613) needs to be ordered to support add-in GPGPU cards.</p>
	<p>P4216XXMHJC 916974 00735858235792 5032037030540 1</p>	<p>A general purpose pedestal chassis targeted at small to medium business supporting CEB and EEB form factor server boards with 2.5" Hot-Swap HDDs, 1200W Cold-Redundant Power Supplies and Redundant Cooling</p> <p>Includes: 16 x 2.5" Hot-Swap Drive Carriers, 2x 1200W Common Redundant Power Supply (Platinum Efficiency), 5x 80mm hot-swap fans, one 480mm miniSAS cable with one vertical miniSAS header and 4 vertical SATA headers, one 100mm HotSwapBackPlane power cable with one 4-pin ATX power header and one 2x2 header.</p> <p>Note: This chassis is compatible with multiple server board skus. As such the specific airduct and cables for that server board needs to be ordered seperately. This chassis does not have any airduct.</p> <p>AUPMGPURBR(920613) needs to be ordered to support add-in GPGPU cards.</p>

	<p>P4308XXMHJC 916316 00735858235815 5032037030564 1</p>	<p>A general purpose pedestal chassis targeted at small to medium business supporting CEB and EEB form factor server boards with 3.5" Hot-Swap HDDs, 1200W Cold-Redundant Power Supplies and Redundant Cooling</p> <p>Includes: 8 x 3.5" Hot-Swap Drive Carriers, 2x 1200W Common Redundant Power Supply (Platinum Efficiency), 5x 80mm hot-swap fans, one 480mm miniSAS cable with one vertical miniSAS header and 4 vertical SATA headers, one 100mm HotSwapBackPlane power cable with one 4-pin ATX power header and one 2x2 header.</p> <p>Note: This chassis is compatible with multiple server board skus. As such the specific airduct and cables for that server board needs to be ordered seperately. This chassis does not have any airduct. AUPMGPURBR(920613) needs to be ordered to support add-in GPGPU cards.</p>
	<p>P4216XXMHGC 916309 00735858244558 5032037039123 1</p>	<p>A general purpose pedestal chassis targeted at small to medium business supporting CEB and EEB form factor server boards with 2.5" Hot-Swap HDDs, 750W Cold-Redundant Power Supplies and Redundant Cooling</p> <p>Includes: 16 x 2.5" Hot-Swap Drive Carriers, 2x 750W Common Redundant Power Supply (Platinum Efficiency), 5x 80mm hot-swap fans, one 480mm miniSAS cable with one vertical miniSAS header and 4 vertical SATA headers, one 100mm HotSwapBackPlane power cable with one 4-pin ATX power header and one 2x2 header.</p> <p>Note: This chassis is compatible with multiple server board skus. As such the specific airduct and cages for that server board needs to be ordered seperately. This chassis does not have any airduct. AUPMGPURBR(920613) needs to be ordered to support add-in GPGPU cards.</p>
	<p>P4216XXMHGR 916311 00735858244565 5032037039130 1</p>	<p>A general purpose pedestal chassis targeted at small to medium business supporting CEB and EEB form factor server boards with 2.5" Hot-Swap HDDs, 750W Cold-Redundant Power Supplies and non-Redundant Cooling</p> <p>Includes: 16x 2.5" Hot-Swap Drive Carriers, 2x 750W Common Redundant Power Supply (Platinum Efficiency), 2x 120mm fixed fans, one 480mm miniSAS cable with one vertical miniSAS header and 4 vertical SATA headers, one 100mm HotSwapBackPlane power cable with one 4-pin ATX power header and one 2x2 header.</p> <p>Note: This chassis is compatible with multiple server board skus. As such the specific airduct and cables for that server board needs to be ordered seperately. AUPMGPURBR(920613) needs to be ordered to support add-in GPGPU cards.</p>

	<p>P4216XXMHEN 916314 00735858244572 5032037039147 1</p>	<p>A general purpose pedestal chassis targeted at small to medium business supporting CEB and EEB form factor server boards with 2.5" Hot Swap HDDs, 550W Fixed Power Supply and non-Redundant Cooling</p> <p>Includes: 16 x 2.5" Hot Swap Drive Carriers, 550W Fixed non-redundant Power Supply (Silver Efficiency), 2x 120mm fixed fans, one 480mm miniSAS cable with one vertical miniSAS header and 4 vertical SATA headers, one 100mm HotSwapBackPlane power cable with one 4-pin ATX power header and one 2x2 header.</p> <p>Note: This chassis is compatible with multiple server board skus. As such the specific airduct and cables for that server board needs to be ordered seperately. This chassis does not have any airduct . AUPMGPURBR(920613) needs to be ordered to support add-in GPGPU cards.</p>
	<p>P4308XXMHGR 916327 00735858244589 5032037039154 1</p>	<p>A general purpose pedestal chassis targeted at small to medium business supporting CEB and EEB form factor server boards with 3.5" Hot-Swap HDDs, 750W Cold-Redundant Power Supplies and non-Redundant Cooling</p> <p>Includes: 8x 3.5" Hot-Swap Drive Carriers, 2x 750W Common Redundant Power Supply (Platinum Efficiency), 2x 120mm fixed fans, one 480mm miniSAS cable with one vertical miniSAS header and 4 vertical SATA headers, one 100mm HotSwapBackPlane power cable with one 4-pin ATX power header and one 2x2 header.</p> <p>Note: This chassis is compatible with multiple server board skus. As such the specific airduct and cables for that server board needs to be ordered seperately. This chassis does not have any airduct. AUPMGPURBR(920613) needs to be ordered to support add-in GPGPU cards.</p>
	<p>P4308XXMHGN 916328 00735858244596 5032037039161 1</p>	<p>A general purpose pedestal chassis targeted at small to medium business supporting CEB and EEB form factor server boards with 3.5" Hot-Swap HDDs, single 750W Cold-Redundant Power Supplies and non-Redundant Cooling</p> <p>Includes: 8x 3.5" Hot-Swap Drive Carriers, 1x 750W Common Redundant Power Supply (Platinum Efficiency), 2x 120mm fixed fans, one 480mm miniSAS cable with one vertical miniSAS header and 4 vertical SATA headers, one 100mm HotSwapBackPlane power cable with one 4-pin ATX power header and one 2x2 header.</p> <p>Note: This chassis is compatible with multiple server board skus. As such the specific airduct and cables for that server board needs to be ordered seperately. This chassis does not have any airduct. AUPMGPURBR(920613) needs to be ordered to support add-in GPGPU cards.</p>





	<p>P4308XXMFGR 916329 00735858244602 5032037039178 1</p>	<p>A general purpose pedestal chassis targeted at small to medium business supporting CEB and EEB form factor server boards with 3.5" Fixed HDDs, 750W Cold-Redundant Power Supplies and non-Redundant Cooling</p> <p>Includes: 8x 3.5" Fixed Drive Carriers, 2x 750W Common Redundant Power Supply (Platinum Efficiency), 2x 120mm fixed fans, two 150mm SATA power cables with one 4-pin ATX power header and 2 vertical SATA power headers, four 600mm SATA cables , each cable has one vertical SATA header and one right angle SATA header.</p> <p>Note: This chassis is compatible with multiple server board skus. As such the specific airduct and cables for that server board needs to be ordered seperately. This chassis does not have any airduct. AUPMGPURBR(920613) needs to be ordered to support add-in GPGPU cards.</p>
	<p>P4308XXMHDR 916331 00735858244619 5032037039185 1</p>	<p>A general purpose pedestal chassis targeted at small to medium business supporting CEB and EEB form factor server boards with 3.5" Hot-Swap HDDs, 460W Cold-Redundant Power Supplies and non-Redundant Cooling</p> <p>Includes: 8x 3.5" Hot-Swap Drive Carriers, 2x 460W Common Redundant Power Supply (Platinum Efficiency), 2x 120mm fixed fans, one 480mm miniSAS cable with one vertical miniSAS header and 4 vertical SATA headers, one 100mm HotSwapBackPlane power cable with one 4-pin ATX power header and one 2x2 header.</p> <p>Note: This chassis is compatible with multiple server board skus. As such the specific airduct and cables for that server board needs to be ordered seperately. This chassis does not have any airduct. AUPMGPURBR(920613) needs to be ordered to support add-in GPGPU cards.</p>
	<p>P4308XXMHDN 916332 00735858244626 5032037039192 1</p>	<p>A general purpose pedestal chassis targeted at small to medium business supporting CEB and EEB form factor server boards with 3.5" Hot-Swap HDDs, single 460W Cold-Redundant Power Supplies and non-Redundant Cooling</p> <p>Includes: 8x 3.5" Hot-Swap Drive Carriers, 1x 460W Common Redundant Power Supply (Platinum Efficiency), 2x 120mm fixed fans, one 480mm miniSAS cable with one vertical miniSAS header and 4 vertical SATA headers, one 100mm HotSwapBackPlane power cable with one 4-pin ATX power header and one 2x2 header.</p> <p>Note: This chassis is compatible with multiple server board skus. As such the specific airduct and cables for that server board needs to be ordered seperately. This chassis does not have any airduct. AUPMGPURBR(920613) needs to be ordered to support add-in GPGPU cards.</p>

	<p>P4308XXMFDR 916333 00735858244633 5032037039208 1</p>	<p>A general purpose pedestal chassis targeted at small to medium business supporting CEB and EEB form factor server boards with 3.5" Fixed HDDs, 460W Cold-Redundant Power Supplies and non-Redundant Cooling</p> <p>Includes: 8x 3.5" Fixed Drive Carriers, 2x 460W Common Redundant Power Supply (Platinum Efficiency), 2x 120mm fixed fans, two 150mm SATA power cables with one 4-pin ATX power header and 2 vertical SATA power headers, four 600mm SATA cables , each cable has one vertical SATA header and one right angle SATA header.</p> <p>Note: This chassis is compatible with multiple server board skus. As such the specific airduct and cables for that server board needs to be ordered seperately. This chassis does not have any airduct. AUPMGPURBR(920613) needs to be ordered to support add-in GPGPU cards.</p>
	<p>P4308XXMFDN 916334 00735858244640 5032037039215 1</p>	<p>A general purpose pedestal chassis targeted at small to medium business supporting CEB and EEB form factor server boards with 3.5" Fixed HDDs, single 460W Cold-Redundant Power Supplies and non-Redundant Cooling</p> <p>Includes: 8x 3.5" Fixed Drive Carriers, 1x 460W Common Redundant Power Supply (Platinum Efficiency), 2x 120mm fixed fans,two 150mm SATA power cables with one 4-pin ATX power header and 2 vertical SATA power headers, four 600mm SATA cables , each cable has one vertical SATA header and one right angle SATA header.</p> <p>Note: This chassis is compatible with multiple server board skus. As such the specific airduct and cables for that server board needs to be ordered seperately. This chassis does not have any airduct. AUPMGPURBR(920613) needs to be ordered to support add-in GPGPU cards.</p>
	<p>P4304XXMHEN 916336 00735858244657 5032037039222 1</p>	<p>A general purpose pedestal chassis targeted at small to medium business supporting CEB and EEB form factor server boards with 3.5" Hot-Swap HDDs, 1x 550W Fixed Power Supplies and non-Redundant Cooling</p> <p>Includes: 4x 3.5" Hot-Swap Drive Carriers, 550W Fixed Power Supply (Silver Efficiency), 2x 120mm fixed fans, one 480mm miniSAS cable with one vertical miniSAS header and 4 vertical SATA headers, one 100mm HotSwapBackPlane power cable with one 4-pin ATX power header and one 2x2 header.</p> <p>Note: This chassis is compatible with multiple server board skus. As such the specific airduct and cables for that server board needs to be ordered seperately. This chassis does not have any airduct. AUPMGPURBR(920613) needs to be ordered to support add-in GPGPU cards.</p>





 <p>Electronics (eg. Intel® Server Component Extended Warranty) 30 Day</p> <p>Intel® Server Component Extended Warranty Key AAAA-AAAA-AAAA-AAAA MSFP</p> <p>Expiration: 30 Days</p> <p>Instructions to enable Intel® Server Component Extended Warranty:</p> <ol style="list-style-type: none"> 1. Report the system serial number of the Intel® Server System, Intel® Server Board, Intel® RAID Controller or Intel® Storage Server using the guides on the second page of this document. 2. Log the http://www.intel.com/go/psw within 30 days of the purchase and type the serial number you recorded in step 1 and the extended warranty key above. After you complete the registration your product will be added to the extended warranty service. 3. For more details, visit www.intel.com/go/psw. 	<p>SVCEWDPSY</p> <p>911295</p> <p>1</p>	<p>Two year extended warranty for Intel® Server Systems or Intel® Server Knock Down Kits + Intel® Server Boards that support two processors. Intel® RAID controller extended warranty is purchased separately.</p> <p>Can be applied to the following SKUs:</p> <p>P4216XXMHJC, P4216XXMHGC, P4208XXMHGC, P4216XXMHGR, P4208XXMHGR, P4208XXMHDR, P4216XXMHEN, P4208XXMHEN, P4308XXMHJC, P4308XXMHGC, P4308XXMHGR, P4308XXMHGN, P4308XXMFGR, P4308XXMFGN, P4308XXMHDR, P4308XXMHDN, P4308XXMFDN, P4308XXMFEN</p>
 <p>Electronics (eg. Intel® Server Component Extended Warranty) 30 Day</p> <p>Intel® Server Component Extended Warranty Key AAAA-AAAA-AAAA-AAAA MSFP</p> <p>Expiration: 30 Days</p> <p>Instructions to enable Intel® Server Component Extended Warranty:</p> <ol style="list-style-type: none"> 1. Report the system serial number of the Intel® Server System, Intel® Server Board, Intel® RAID Controller or Intel® Storage Server using the guides on the second page of this document. 2. Log the http://www.intel.com/go/psw within 30 days of the purchase and type the serial number you recorded in step 1 and the extended warranty key above. After you complete the registration your product will be added to the extended warranty service. 3. For more details, visit www.intel.com/go/psw. 	<p>SVCEWDPBD</p> <p>911294</p> <p>1</p>	<p>Two year extended warranty for Intel® Server Boards that support two processors.</p>







2. Spares and Accessories Order Codes

2.1 General Spares and Accessories







Image	Product Code MM UPC EAN MOQ	Description
	AS2600COIOS 919562 00735858240017 5032037034753 50	I/O Shield accessory for Intel® S2600CO Server Board
 <p style="text-align: center;">With</p>	FCOUPMAD 919559 00735858236133 5032037030915 1	Air duct and unique cable kit for Intel® Server Board S2600CO to be used Intel® Server Chassis P4000M Included cables: 4 pcs SATA Cables; MiniSAS(hot-swap backplane) to SATA Cable(with 5-pin SGPIO); SGPIO Cable Power cable extension for connecting 24-pin power cable to S2600CO board for use in P4000M chassis Note: Common cables are remained in P4000M chassis package
	AUPM1394CBL 919563 00735858240024 5032037034760 1	1394 Cable and mounting kit (unique for Intel® S2600CO Server Board)
	AXXELVRAIL 920970 00735858244367 5032037038980 1	Value Rail Kit, half extension, extended inner slide member Works for 438mm wide Intel 2U/4U Rack Chassis and System families (H2000, R2000LH/R2000LT Swan Peak 2U, P4000M/P4000L/P4000L-WS)
	AXX3U5UPRAIL 915634 00735858236119 5032037030892 1	Advanced rail kit for P4000M/P4000L/P4000L-WS Server Chassis used when converting Pedestal chassis to 4U rack chassis, and full extension rails are needed. Includes: two rails

	<p>AXX3U5UCMA 915635 00735858236126 5032037030908 1</p>	<p>Rack Cable Management AXX3U5UCMA (For Use with Advanced Rail Kit AXX3U5UPRAIL for Intel® Server Chassis P4000M/P4000L/P4000L-WS Family)</p>
	<p>FFPANEL 911682 00735858219327 5032037019255 5</p>	<p>Front Panel board spare for P4000, R1000, R2000 server chassis</p>
	<p>FXXFPANEL 915982 00735858222419 5032037018968 1</p>	<p>Front Panel board spare for P4000, R1000, R2000 server chassis</p>
	<p>A4ULCP 921029 00735858244695 5032037039260 1</p>	<p>LCP Module (local control panel) Enables system to display critical errors from SEL for instant diagnostic. Also allows custom message for branding. Available in Q4'2012</p>
	<p>FUPBEZELFIX2 925750 1</p>	<p>Bezel spare for P4000M server chassis with fixed drives (no door)</p>
	<p>FUPBEZELHSD2 925749</p>	<p>Bezel spare for P4000 server chassis with Hot Swap HDDs (with door for hot swap bays) (fits P4304, P4308, P4208, and P4216 with hot swap drive bays installed)</p>

	<p>AUPBEZEL4UF 915636 00735858235976 5032037030731 1</p>	<p>Rack bezel kit for converting P4000 pedestal server chassis to rack chassis</p> <p>Includes: bezel frame, and 2 rack handles</p>
	<p>AUPBEZEL4UD 915637 00735858235983 5032037030748 1</p>	<p>Rack bezel accessory for P4000M/P4000L/P4000L-WS chassis in rack configuration - security door only</p>
<p>Image not yet available</p>	<p>FUPMMSK 915638 00735858235990 5032037030755 1</p>	<p>Chassis Maintenance kit for P4000M (Mechanical Spares Kit)</p> <p>Including EMI cover, ODD rail, PCI card retainer {4x 3.5" EMI cover, 8x 3.5" EMI cover, ODD rail x4, #6-32 screw x20, M3x12 USB cable screw x2, M2x10 Intrusion cable</p>
	<p>FUPMESK 915653 00735858236003 5032037030762 1</p>	<p>Chassis Maintenance kit for P4000M (Electric Spares Kit)</p> <p>Includes:</p> <ul style="list-style-type: none"> ● 2x SATA power cables, one 4-pin ATX power header to two SATA power headers, 150mm ● 2x SAS cables, one mini SAS header to four SATA vertical headers without SGPIO , 600mm ● 1x SATA cable, 1x mini SAS header to 4x SATA vertical headers with SGPIO , 600mm ● 1x I2C cable, one 5-pin header to one 3-pin header, 600mm ● 1x I2C cable, one 5-pin header to one 5-pin header, 200mm ● 1x HotSwapBackPlane adapter power cable, one 1x4 pin header to one 2x2 pin header, 100mm. ● 2x GPGPU power cables, one 2x2 pin header to one 2x4 pin header plus one 2x3 pin header, 1100mm ● 5x fan signal cables for fan 1 to 5, 350mm ● 1x intrusion cable, 200mm ● 1x front panel cable, 920mm ● 1x USB Cable, one 2x5 pin header to two USB type A female headers, 950mm
	<p>FPWRCABLENA 879287 00735858181129 1</p>	<p>North American Power Cord Spare</p>

	AUPMGPUBR 920613 00735858244428 5032037039048 1	Bracket for securing full length double width GPU cards to fan bulkhead, for use in P4000M, includes 1 bracket, 2 1100mm GPGPU power cables, and screws. Each GPGPU power cable has one 2x2 pin header to one 2x3 pin header plus one 2x1 header and one 2x3 pin header. The 2x3 header plus the 2x1 header can combine to a standard 2x4 pin header per GPGPU card's requirement.
Image not yet available	AUPMCOPROBR 926364 1	Bracket for securing Intel® Xeon® Phi™ Coprocessor PCI Express* Card in P4000M, includes 1 bracket, 2 GPGPU power cables, 2 Intel® Xeon® Phi™ Coprocessor PCI Express* Card extension brackets , screws
	AUPSRCBTP 915293 00735858238724 5032037033497 2	The production Intel® heat sink, SRC-B tower passive, 98mmx100mm, required for production Intel® server boards S2600CP, S2600CO4/S2600COE and S2600IP to be used in production Intel® 4U pedestal server chassis with up to 135W CPU installed
	AUPSRCBTA 915294 00735858236164 5032037030939 2	The production Intel® heat sink, SRC-B tower active, 98mmx100mm, required for production Intel® S2600CR workstation board to be used in production Intel® 4U workstation chassis P4000L-WS series, or Intel® Server Board 2600COE to be used in production Intel® 4U pedestal chassis P4000M with 150W CPU installed
	FUPMLHSFAN 915620 00735858235969 5032037030724 1	80mm system fan kit for P4000M/P4000L server chassis includes fan, fan holder, for use in redundant cooling configuration
	FUPNHFANCPU MM# 919572 00735858236034 5032037030793 1	Fixed Fan Spare Kit for CPU area for P4000M, or CPU area for P4000L-WS Includes; (1) 120mm fixed fan
	FUPMNHFANPCI MM# 919575 00735858236041 5032037030809 1	Fixed Fan spare kit for P4000M for PCI area fan, or P4000L-WS for PCI area fan; Includes; (1) 120mm fixed fan



2.2 Power Sub-system Spares

Image	Product Code MM UPC	Description
	FUP550SNRPS 915602 00735858235839 5032037030588 1	550W Fixed Power supply spare for P4000 chassis 80Plus Silver efficiency
	FXX460GCRPS 915603 00735858235846 5032037030595 1	460W Cold Redundant Power Supply spare 80Plus Gold efficiency for P4000, R1000, and R2000 server chassis
	FXX750PCRPS 915604 00735858234979 5032037030601 1	750W Cold Redundant Power Supply spare 80Plus Platinum efficiency for P4000, R1000, and R2000 server chassis
Image not yet available	FUPNRPSADP 912769 00735858219471 5032037016278 1	P4000 Non-Redundant Power Supply adaptor kit Includes; bracket, screws, locker
	FUPCRPSCAGE 915607 00735858235891 5032037030656 1	Common Pedestal CRPS PSU cage assembly (cage, adaptor bracket, screws, supporting bulkhead, 1x blank filler)
	FUPPDBLC 916812 00735858238731 5032037033510 1	Power Distribution Board Spare (Low Current) for P4000 server chassis. Recommend to use with FXX460GCRPS or FXX750PCRPS power supplies.
	FUPPDBHC 916813 00735858238748 5032037033527 1	Power Distribution Board Spare (High Current) for P4000 server chassis. Recommend to use with FXX750PCRPS, FXX1200PCRPS or FXX1600PCRPS power supplies.

	<p>FXX1200PCRPS 915605</p> <p>735858225137 5032037035071 1</p>	<p>1200W Cold Redundant Power Supply spare 80Plus Platinum efficiency for P4000, and R2000 server chassis</p>
---	--	---

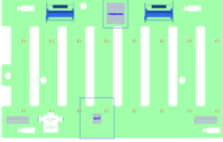
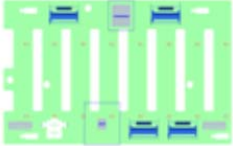
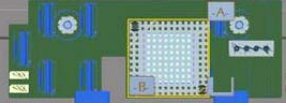
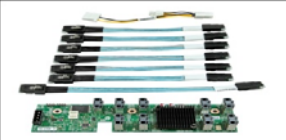

2.3 Drive/storage subsystem spares and accessories

Image	Product Code MM UPC	Description
	<p>FUP4X35HSDK 911885 00735858219440 5032037016230 1</p>	<p>3.5" Hot Swap Drive Kit for P4000 server chassis</p> <p>Includes: Drive Cage, Hot Swap Back Plane, 4 Hot Swap Drive carriers, data cables, I2C cable, and ID filler</p>
	<p>FUP8X35HSDK 915608 00735858235907 5032037030663 1</p>	<p>8x3.5" Hot Swap Drive Cage Kit for P4000 server chassis</p> <p>Includes: Drive Cage, Hot Swap Back Plane, 8 Hot Swap Drive Carriers, data cables, I2C cable, and ID filler panel</p>
	<p>FUP8X25HSDKS 915819 00735858235914 5032037030670 1</p>	<p>8x2.5 Hot Swap Drive Cage Kit for P4000 server chassis</p> <p>Includes: Drive cage, Hot Swap Back Plane, 8 Hot Swap Drive carriers, data cables, I2C cable, ID filler panels, and power adaptor cable accessory</p>
	<p>FXX35HSADPB 912771 00735858219495 5032037016391 8</p>	<p>3.5" HDD Hot Swap Drive Carrier spares for either R1300, R2300, or P4300 chassis families</p>
	<p>FXX25HSCAR 918807 00735858241182 5032037035910 8</p>	<p>2.5" HDD Hot Swap Drive Carrier spares for either R1200, R2200, or P4200 chassis families</p>
	<p>FUP4X35HSBP 913595 00735858220033 5032037019279 1</p>	<p>Spare 4x3.5" Hot Swap Backplane for use with P4304 server chassis</p> <p>Includes: 3.5" backplane board</p>



	FUP4X35NHDK 912770 00735858219488 5032037016247 4	Fixed Drive Carrier spare for P4300 server chassis (compatible with 2.5" HDDs/SSDs)
Image not yet available	FUP8X35HSBP 916353 00735858222792 5032037033480 1	Hot Swap Back Plane spare for 8x3.5" Drive Cage Kit FUP8X35HSDK for use with P4000 server chassis Includes: (1) 3.5" backplane board
	FXX8X25HSBP 917973 735858240987 5032037035736 1	Spare 8x2.5" Hot Swap Backplane for use with R2200, and P4200 Chassis families Includes: (1) 8x2.5" backplane board
	FXX8X25DPBP 917974 735858240994 5032037035743 1	Spare 8x2.5" Dual Port Hot Swap Backplane for use with R2200, and P4200 Chassis families Includes: (1) 8x2.5" backplane board, dual port
	RES2CV240 918934 735858241175 5032037035903 1	Integrated 24-port 6G SAS expander, compatible with R2200 family and P4000M/P4000L of chassis (only supported in 2.5" drive 2U or 4U chassis) Includes 3 screws and bumpers, 4 cables and power cable. Recommend to use with two 8x 2.5" HSBPs (total 16 drives)
	RES2CV360 918935 735858241168 5032037035897 1	Integrated 36-port 6G SAS expander, compatible with R2200 family and P4000M/P4000L family of chassis (only supported in 2.5" drive 2U or 4U chassis) Includes 3 screws and bumpers, 6 Mini-SAS cables and power cable. Recommend to use with three 8x 2.5" HSBPs (total 24 drives)
	RKSATA4R5 916346 735858238861 5032037033640 5	Enables LSI SATA SW RAID 5, Black
	RKSATA8 916347 735858238878 5032037033657 5	Activates 8 SATA ports and includes RSTe SW RAID 0/1/10/5 and LSI SW RAID 0/1/10 , Blue
	RKSATA8R5 916348 735858238885 5032037033664 5	Activates 8 SATA ports and includes RSTe SW RAID 0/1/10/5 and LSI SW RAID 0/1/10/5 (enables LSI SWR5), White
	RKSAS4 916349 735858238892 5032037033671 5	Activates 4 SAS ports and includes RSTe SW RAID 0/1/10 (no RAID 5) and LSI SW RAID 0/1/10 , Green

	RKSAS4R5 916350 735858238908 5032037033688 5	Activates 4 SAS ports and includes RSTe SW RAID 0/1/10 (no RAID 5) and LSI SW RAID 0/1/10/5 (enables LSI SWR5), Yellow
	RKSAS8 916351 735858238922 5032037033701 5	Activates 8 SAS ports and includes RSTe SW RAID 0/1/10 (no RAID 5) and LSI SW RAID 0/1/10 , Orange
	RKSAS8R5 916352 735858238915 5032037033695 5	Activates 8 SAS ports and includes RSTe SW RAID 0/1/10 (no RAID 5) and LSI SW RAID 0/1/10/5 (enables LSI SWR5), Purple

2.4 Expansion modules: IO Module, SAS Module, RMM4, TPM

Image	Product Code MM UPC	Description
	AXXRMM4LITE 911660 00735858219297 5032037014946 1	Activation key for advanced management features (Note that this is not required for systems where the board is integrated in the chassis)
	AXXRMM4 911670 00735858219303 5032037014922 1	Intel® Remote Management Module RMM4 – Remote KVM upgrade key and Dedicated NIC Module
	AXXTPME5 919737 735858240352 5032037035088	TPM Module for server systems supporting S2600 and S2400 board families.

	<p>AXXQAAPCIE 920562 735858244855 5032037039420 1</p>	<p>Intel® Quick Assist Accelerator PCIe Card</p> <p>Available in Q3'2012</p>
	<p>RMS25KB080</p> <p>735858239028 5032037033800 5</p>	<p>Intel® Integrated RAID Module RMS25KB080, PCIe Slot, LSI2308 I/O Controller, 8P Internal SAS, LSI IR-based RAID 0,1,1E</p> <p>Requires PClex8 slot</p> <p>If using hot-swap disk drives, 2 mini-SAS to mini-SAS cables are required. See product code AXXCBL650MSMS.</p> <p>If using fixed disk drives, 2 SAS cables are required. See Product code AXXCBL850MS7R.</p>
	<p>RMS25KB040</p> <p>735858239035 5032037033817 5</p>	<p>Intel® Integrated RAID Module RMS25KB040, PCIe Slot, LSI2308 I/O Controller, 4P SAS, LSI IR-based RAID 0,1,1E</p> <p>Requires PClex8 slot</p> <p>If using hot-swap disk drives, 2 mini-SAS to mini-SAS cables are required. See product code AXXCBL650MSMS.</p> <p>If using fixed disk drives, 2 SAS cables are required. See Product code AXXCBL850MS7R.</p>
	<p>RMS25PB080</p> <p>735858238946 5032037033725 5</p>	<p>Intel® Integrated RAID Module RMS25PB080, PCIe Slot, LSI2208 ROC, 8P Internal SAS/SATA, LSI MegaRAID-based Firmware, 1GB DDR3, RAID 0,1,10,5,50,6,60</p> <p>Requires PClex8 slot</p> <p>If using hot-swap disk drives, 2 mini-SAS to mini-SAS cables are required. See product code AXXCBL650MSMS.</p> <p>If using fixed disk drives, 2 SAS cables are required. See Product code AXXCBL850MS7R.</p>
	<p>RMS25PB040</p> <p>735858238953 5032037033732 5</p>	<p>Intel® Integrated RAID Module RMS25PB040, PCIe Slot, LSI2208 ROC, 4P Internal SAS/SATA, LSI MegaRAID-based Firmware, 1GB DDR3, RAID 0,1,10,5,50,6,60</p> <p>Requires PClex8 slot</p> <p>If using hot-swap disk drives, 2 mini-SAS to mini-SAS cables are required. See product code AXXCBL650MSMS.</p>

		If using fixed disk drives, 2 SAS cables are required. See Product code AXXCBL850MS7R.
	RMT3PB080 735858238960 5032037033749 5	Intel® Integrated RAID Module RMT3PB080, PCIe Slot, LSI2208 ROC, 8P Internal SATA (only), LSI MegaRAID-based Firmware, 512MB DDR3, Restricted to use only SATA drives, R0,1,10,5,50,6,60 Requires PClex8 slot If using hot-swap disk drives, 2 mini-SAS to mini-SAS cables are required. See product code AXXCBL650MSMS. If using fixed disk drives, 2 SAS cables are required. See Product code AXXCBL850MS7R.
Image not yet available	AXXRMFBU2 919876 735858244541 5032037039116 5	Maintenance Free Backup Unit with NAND Flash and Supercapacitor
	AXXRSBBU9 919738 735858220286 5032037039567 5	Intel® RAID Smart Battery AXXRSBBU9 provides optional battery backup for mainstream RS25, RMS25, RT3 and RMT3 family RAID products.

End of Configuration Guide