

Intel[®] RAID Controller SRCAS18E User's Guide

Intel Order Number: D26788-003

INFORMATION IN THIS DOCUMENT IS PROVIDED IN CONNECTION WITH INTEL(R) PRODUCTS. NO LICENSE, EXPRESS OR IMPLIED, BY ESTOPPEL OR OTHERWISE, TO ANY INTELLECTUAL PROPERTY RIGHTS IS GRANTED BY THIS DOCUMENT. EXCEPT AS PROVIDED IN INTEL'S TERMS AND CONDITIONS OF SALE FOR SUCH PRODUCTS, INTEL ASSUMES NO LIABILITY WHATSOEVER, AND INTEL DISCLAIMS ANY EXPRESS OR IMPLIED WARRANTY, RELATING TO SALE AND/OR USE OF INTEL PRODUCTS INCLUDING LIABILITY OR WARRANTIES RELATING TO FITNESS FOR A PARTICULAR PURPOSE, MERCHANTABILITY, OR INFRINGEMENT OF ANY PATENT, COPYRIGHT OR OTHER INTELLECTUAL PROPERTY RIGHT. Intel products are not intended for use in medical, life saving, life sustaining applications. Intel may make changes to specifications and product descriptions at any time, without notice.

Intel is a trademark or registered trademark of Intel Corporation or its subsidiaries in the United States and other countries.

*Other names and brands may be claimed as the property of others.

Copyright © 2006-2007 by Intel Corporation. Portions Copyright 2005-2006 by LSI Logic Corporation. All rights reserved.

Safety Warnings and Instructions

WARNING: English

Important Safety Instructions

Read all caution and safety statements in this document before performing any of the instructions. See also Intel Server Boards and Server Chassis Safety Information on the Resource CD and/or at <http://support.intel.com/support/motherboards/server/sb/cs-010770.htm>.

	<p>SAFETY STEPS: Whenever you remove the chassis covers to access the inside of the system, follow these steps:</p> <ol style="list-style-type: none">1. Turn off all peripheral devices connected to the system.2. Turn off the system by pressing the power button.3. Unplug all AC power cords from the system or from wall outlets.4. Label and disconnect all cables connected to I/O connectors or ports on the back of the system.5. Provide some electrostatic discharge (ESD) protection by wearing an antistatic wrist strap attached to chassis ground of the system-any unpainted metal surface-when handling components.6. Do not operate the system with the chassis covers removed.
	<p>A microprocessor and heat sink may be hot if the system has been running. Also, there may be sharp pins and edges on some board and chassis parts. Contact should be made with care. Consider wearing protective gloves.</p>

ADVERTENCIAS: Español

Instrucciones de seguridad importantes

Lea todas las declaraciones de seguridad y precaución de este documento antes de realizar cualquiera de las instrucciones. Vea Intel Server Boards and Server Chassis Safety Information en el CD Resource y/o en <http://support.intel.com/support/motherboards/server/sb/cs-010770.htm>.

	<p>NSTRUCCIONES DE SEGURIDAD: Cuando extraiga la tapa del chasis para acceder al interior del sistema, siga las siguientes instrucciones:</p> <ol style="list-style-type: none">1. Apague todos los dispositivos periféricos conectados al sistema.2. Apague el sistema presionando el interruptor encendido/apagado.3. Desconecte todos los cables de alimentación CA del sistema o de las tomas de corriente alterna.4. Identifique y desconecte todos los cables enchufados a los conectores E/S o a los puertos situados en la parte posterior del sistema.5. Cuando manipule los componentes, es importante protegerse contra la descarga electrostática (ESD). Puede hacerlo si utiliza una muñequera antiestática sujeta a la toma de tierra del chasis - o a cualquier tipo de superficie de metal sin pintar.6. No ponga en marcha el sistema si se han extraído las tapas del chasis.
---	---

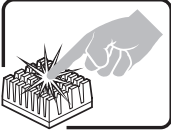
	<p>Si el sistema ha estado en funcionamiento, el microprocesador y el disipador de calor pueden estar aún calientes. También conviene tener en cuenta que en el chasis o en el tablero puede haber piezas cortantes o punzantes. Por ello, se recomienda precaución y el uso de guantes protectores.</p>
---	--

WARNUNG: Deutsch

Wichtige Sicherheitshinweise

Lesen Sie zunächst sämtliche Warn- und Sicherheitshinweise in diesem Dokument, bevor Sie eine der Anweisungen ausführen. Beachten Sie hierzu auch die Sicherheitshinweise zu Intel-Serverplatinen und -Servergehäusen auf der Ressourcen-CD oder unter <http://support.intel.com/support/motherboards/server/sb/cs-010770.htm>.

	<p>SICHERHEISSMASSNAHMEN: Immer wenn Sie die Gehäuseabdeckung abnehmen um an das Systeminnere zu gelangen, sollten Sie folgende Schritte beachten:</p> <ol style="list-style-type: none"> 1. Schalten Sie alle an Ihr System angeschlossenen Peripheriegeräte aus. 2. Schalten Sie das System mit dem Hauptschalter aus. 3. Ziehen Sie den Stromanschlußstecker Ihres Systems aus der Steckdose. 4. Auf der Rückseite des Systems beschrifteten und ziehen Sie alle Anschlußkabel von den I/O Anschlüssen oder Ports ab. 5. Tragen Sie ein geerdetes Antistatik Gelenkband, um elektrostatische Ladungen (ESD) über blanke Metallstellen bei der Handhabung der Komponenten zu vermeiden. 6. Schalten Sie das System niemals ohne ordnungsgemäß montiertes Gehäuse ein.
	<p>Der Mikroprozessor und der Kühler sind möglicherweise erhitzt, wenn das System in Betrieb ist. Außerdem können einige Platinen und Gehäuseteile scharfe Spitzen und Kanten aufweisen. Arbeiten an Platinen und Gehäuse sollten vorsichtig ausgeführt werden. Sie sollten Schutzhandschuhe tragen.</p>

AVERTISSEMENT: Français

Consignes de sécurité

Lisez attention toutes les consignes de sécurité et les mises en garde indiquées dans ce document avant de suivre toute instruction. Consultez Intel Server Boards and Server Chassis Safety Information sur le CD Resource CD ou bien rendez-vous sur le site <http://support.intel.com/support/motherboards/server/sb/cs-010770.htm>.

	<p>CONSIGNES DE SÉCURITÉ: Lorsque vous ouvrez le boîtier pour accéder à l'intérieur du système, suivez les consignes suivantes:</p> <ol style="list-style-type: none">1. Mettez hors tension tous les périphériques connectés au système.2. Mettez le système hors tension en mettant l'interrupteur général en position OFF (bouton-poussoir).3. Débranchez tous les cordons d'alimentation c.a. du système et des prises murales.4. Identifiez et débranchez tous les câbles reliés aux connecteurs d'E-S ou aux accès derrière le système.5. Pour prévenir les décharges électrostatiques lorsque vous touchez aux composants, portez une bande antistatique pour poignet et reliez-la à la masse du système (toute surface métallique non peinte du boîtier).6. Ne faites pas fonctionner le système tandis que le boîtier est ouvert.
	<p>Le microprocesseur et le dissipateur de chaleur peuvent être chauds si le système a été sous tension. Faites également attention aux broches aiguës des cartes et aux bords tranchants du capot. Nous vous recommandons l'usage de gants de protection.</p>

AVVERTENZA: Italiano

	<p>PASSI DI SICUREZZA: Qualora si rimuovano le coperture del telaio per accedere all'interno del sistema, seguire i seguenti passi:</p> <ol style="list-style-type: none">1. Spegner tutti i dispositivi periferici collegati al sistema.2. Spegner il sistema, usando il pulsante spento/accesso dell'interruttore del sistema.3. Togliere tutte le spine dei cavi del sistema dalle prese elettriche.4. Identificare e sconnettere tutti i cavi attaccati ai collegamenti I/O od alle prese installate sul retro del sistema.5. Qualora si tocchino i componenti, proteggersi dallo scarico elettrostatico (SES), portando un cinghia anti-statica da polso che è attaccata alla presa a terra del telaio del sistema - qualsiasi superficie non dipinta.6. Non far operare il sistema quando il telaio è senza le coperture.
	<p>Se il sistema è stato a lungo in funzione, il microprocessore e il dissipatore di calore potrebbero essere surriscaldati. Fare attenzione alla presenza di piedini appuntiti e parti taglienti sulle schede e sul telaio. È consigliabile l'uso di guanti di protezione.</p>

When Using Your Computer System

As you use your computer system, observe the following safety guidelines:

Caution: Do not operate your computer system with any cover(s) (such as computer covers, bezels, filler brackets, and front-panel inserts) removed:

- To help avoid damaging your computer, be sure the voltage selection switch on the power supply is set to match the alternating current (AC) power available at your location:
 - 115 volts (V)/60 hertz (Hz) in most of North and South America and some Far Eastern countries such as Japan, South Korea, and Taiwan
 - 230 V/50 Hz in most of Europe, the Middle East, and the Far East. Also be sure your monitor and attached peripherals are electrically rated to operate with the AC power available in your location.
- To help avoid possible damage to the server board, wait five seconds after turning off the system before removing a component from the server board or disconnecting a peripheral device from the computer.
- To help prevent electric shock, plug the computer and peripheral power cables into properly grounded power sources. These cables are equipped with 3-prong plugs to ensure proper grounding. Do not use adapter plugs or remove the grounding prong from a cable. If you must use an extension cable, use a 3-wire cable with properly grounded plugs.
- To help protect your computer system from sudden, transient increases and decreases in electrical power, use a surge suppressor, line conditioner, or uninterruptible power supply.
- Be sure nothing rests on your computer system's cables and that the cables are not located where they can be stepped on or tripped over.
- Do not spill food or liquids on your computer. If the computer gets wet, consult the documentation that came with it.
- Do not push any objects into the openings of your computer. Doing so can cause fire or electric shock by shorting out interior components.
- Keep your computer away from radiators and heat sources. Also, do not block cooling vents. Avoid placing loose papers underneath your computer; do not place your computer in a closed-in wall unit or on a rug.

When Working Inside Your Computer

Note: Do not attempt to service the computer system yourself, except as explained in this guide and elsewhere in Intel documentation. Always follow installation and service instructions closely.

1. Turn off your computer and any peripherals.
2. Disconnect your computer and peripherals from their power sources. Also disconnect any telephone or telecommunications lines from the computer.

Doing so reduces the potential for personal injury or shock.

Also note these safety guidelines:

- When you disconnect a cable, pull on its connector or on its strain-relief loop, not on the cable itself. Some cables have a connector with locking tabs; if you are disconnecting this type of cable, press in on the locking tabs before disconnect the cable. As you pull connectors apart, keep them evenly aligned to avoid bending any connector pins. Also, before you connect a cable, make sure both connectors are correctly oriented and aligned.
- Handle components and cards with care. Don't touch the components or contacts on a card. Hold a card by its edges or by its metal mounting bracket. Hold a component such as a microprocessor chip by its edges, not by its pins.

Protecting Against Electrostatic Discharge

Static electricity can harm delicate components inside your computer. To prevent static damage, discharge static electricity from your body before you touch any of your computer's electronic components, such as the microprocessor. You can do so by touching an unpainted metal surface, such as the metal around the card-slot openings at the back of the computer.

As you continue to work inside the computer, periodically touch an unpainted metal surface to remove any static charge your body may have accumulated. In addition to the preceding precautions, you can also take the following steps to prevent damage from electrostatic discharge (ESD):

- When unpacking a static-sensitive component from its shipping carton, do not remove the component from the antistatic packing material until you are ready to install the component in your computer. Just before unwrapping the antistatic packaging, be sure to discharge static electricity from your body.
- When transporting a sensitive component, first place it in an antistatic container or packaging.
- Handle all sensitive components in a static-safe area. If possible, use antistatic floor pads and workbench pads.

Regulatory and Certification Information

Product Regulatory Compliance

This RAID Controller Card complies with the following safety and electromagnetic compatibility (EMC) regulations.

Product Safety Compliance

- UL 1950 - CSA 950 (US/Canada)
- EN 60 950 (European Union)
- IEC60 950 (International)
- CE - Low Voltage Directive (73/23/EEC) (European Union)





Product EMC Compliance - Class B



- FCC /ICES-003 (USA/Canada)
- CISPR 22 (International)
- EN55022 (Europe)
- EN55024 (Europe)
- CE - EMC Directive 89/336/EEC (Europe)
- VCCI (Japan)
- AS/NZS 3548 (Australia / New Zealand)
- BSMI CNS13438 (Taiwan)
- RRL, MIC Notice No. 1997-41 (EMC) & 1997-42 (EMI) (Korea)

Product Regulatory Compliance Markings

The RAID controller card is marked with the following compliance markings. Some marking information may be provided on the packaging and/or in the product documentation due to limited marking space on the product.

- ETL NRTL Mark (US/Canada)
- FCC Mark (US)
- ICES-003 (Canada)
- CE Mark (Europe)
- VCCI Mark (Japan)
- MIC Mark (Korea)
- BSMI DOC Mark (Taiwan)
- ACS C-Tick Mark (Australia)

Regulatory Compliance	Country	Marking
cULus Listing Marks	USA/Canada	
ETL (NRTL) Mark	USA/Canada	
CE Mark	Europe	
FCC Marking (Class A)	USA	This device complies with Part 15 of the FCC Rules. Operation of this device is subject to the following two conditions: (1) This device may not cause harmful interference, and (2) This device must accept any interference received, including interference that may cause undesired operation.
FCC Marking (Class B)	USA	 Tested to Comply With FCC standards FOR HOME OR OFFICE USE
EMC Marking (Class A)	Canada	CANADA ICES-003 CLASS A CANADA NMB-003 CLASSE A
EMC Marking (Class B)	Canada	CANADA ICES-003 CLASS B CANADA NMB-003 CLASSE B
VCCI Marking (Class A)	Japan	この装置は、情報処理装置等電波障害自主規制協議会（VCCI）の基準に基づくクラスA情報技術装置です。この装置を家庭環境で使用すると電波妨害を引き起こすことがあります。この場合には使用者が適切な対策を講ずるよう要求されることがあります。
VCCI Marking (Class B)	Japan	この装置は、情報処理装置等電波障害自主規制協議会（VCCI）の基準に基づくクラスB情報技術装置です。この装置は、家庭環境で使用することを目的としていますが、この装置がラジオやテレビジョン受信機に近接して使用されると、受信障害を引き起こすことがあります。 取扱説明書に従って正しい取り扱いをして下さい。 

Regulatory Compliance	Country	Marking
BSMI Marking (Class A or B) and Class A EMC Warning	Taiwan	 <p>警告使用者： 這是甲類的資訊產品，在居住的環境中使用時，可能會造成射頻干擾，在這種情況下，使用者會被要求採取某些適當的對策</p>
RRL MIC Mark	Korea	
C-Tick Mark	Australia	

Electromagnetic Compatibility Notices

FCC Verification Statement (USA)

This device complies with Part 15 of the FCC Rules. Operation is subject to the following two conditions: (1) This device may not cause harmful interference, and (2) this device must accept any interference received, including interference that may cause undesired operation.

Intel Corporation
5200 N.E. Elam Young Parkway
Hillsboro, OR 97124-6497
Phone: 1-800-628-8686

This equipment has been tested and found to comply with the limits for a Class B digital device, pursuant to Part 15 of the FCC Rules. These limits are designed to provide reasonable protection against harmful interference in a residential installation. This equipment generates, uses, and can radiate radio frequency energy and, if not installed and used in accordance with the instructions, may cause harmful interference to radio communications. However, there is no guarantee that interference will not occur in a particular installation. If this equipment does cause harmful interference to radio or television reception, which can be determined by turning the equipment off and on, the user is encouraged to try to correct the interference by one or more of the following measures:

- Reorient or relocate the receiving antenna.
- Increase the separation between the equipment and the receiver.
- Connect the equipment into an outlet on a circuit different from that to which the receiver is connected.
- Consult the dealer or an experienced radio/TV technician for help.

Intel is not responsible for any radio or television interference caused by unauthorized modification of this equipment for substitution or attachment of connecting cables and equipment other than those specified by Intel. The correction of interferences caused by such unauthorized modification, substitution, or attachment will be the responsibility of the user.

This RAID controller card has been tested to comply with FCC Standards for home or office use.

ICES-003 (Canada)

This digital apparatus does not exceed the Class B limits for radio noise emissions from digital apparatus set out in the interference-causing equipment standard entitled "Digital Apparatus," ICES-003 of the Canadian Department of Communications.

Cet appareil numérique respecte les limites bruits radioélectriques applicables aux appareils numériques de Classe Aprescrites dans la norme sur le matériel brouilleur: "Appareils Numériques", NMB-003 édictée par le Ministre Canadien des Communications.

Europe (CE Declaration of Conformity)

This product has been tested in accordance too, and complies with the Low Voltage Directive (73/23/EEC) and EMC Directive (89/336/EEC). The product has been marked with the CE Mark to illustrate its compliance.

RRL (Korea)

English translation of the notice above:

1. Type of Equipment (Model Name): Model name on product
2. Certification No.: On RRL certificate. Obtain certificate from local Intel representative
3. Name of Certification Recipient: LSI Logic Corporation
4. Date of Manufacturer: Refer to date code on product
5. Manufacturer/Nation: LSI Logic Corporation / Refer to country of origin marked on product

Preface

This is the primary reference and user's guide for the Intel® RAID Controller SRCSAS18E, which can be used for SAS and SATA disk drives. It contains installation instructions and specifications.

For details on how to configure the storage adapters, and for an overview of the software drivers, see the *Software User's Guide* on the Resource CD.

Audience

This document assumes that you have some familiarity with RAID controllers and related support devices. The people who benefit from this book are:

- Engineers who are designing a RAID Controller SRCSAS18E storage adapter into a system
- Anyone installing a RAID Controller SRCSAS18E storage adapter in their RAID system

Organization

This document includes the following chapters and appendixes:

- Chapter 1 provides a general overview of the Intel® RAID Controller SRCSAS18E.
- Chapter 2 describes the procedures for installing the RAID Controller SRCSAS18E storage adapter.
- Chapter 3 provides the characteristics and technical specifications for the RAID Controller SRCSAS18E storage adapter.
- Appendix A lists and explains the terms and abbreviations used in this manual.

Related Publication

The *Software User's Guide* on the Resource CD that is included with the RAID controller.

Contents

Safety Warnings and Instructions	iii
Regulatory and Certification Information	viii
Electromagnetic Compatibility Notices	xi
Preface	xiii
Audience	xiii
Organization	xiii
Related Publication	xiii
Chapter 1, Overview	1
SAS Controller Description	2
Configuration Scenarios	2
Benefits of SAS	3
PCI Express* Architecture	4
Operating System Support	4
Summary of SAS RAID Controller Features	4
SAS Features	5
SATA Features	5
PCI Performance	5
Flexibility	6
Drive Roaming	6
Drive Migration	7
Hardware Specifications	8
Chapter 2, Intel® RAID Controller SRC SAS18E Hardware Installation	9
Requirements	9
Quick Installation	10
Detailed Installation	10
SAS Device Cables	12
Replacing a Failed Controller that Contains Data in the Intel® RAID Portable Cache Module 2 17	17
After Installing the Storage Adapter	18
Chapter 3, Intel® RAID Controller SRC SAS18E Characteristics	19
Characteristics	20
Technical Specifications	21
Array Performance Features	22
Fault Tolerance	22
Electrical Characteristics	23
Thermal and Atmospheric Characteristics	23
Safety Characteristics	23
A. Glossary of Terms and Abbreviations	24

Figures

Figure 1. Example Direct-Connect Application.....	3
Figure 2. Inserting the Intel® RAID Controller SRCSAS18E Card in a PCI Express* Slot.....	11
Figure 3. Internal SAS Cable for Connection to SAS and SATA Hard Disk Drives.....	13
Figure 4. Serial ATA Connectors.....	13
Figure 5. SAS and SATA Plugs and SAS Backplane Receptacle Connector	14
Figure 6. Intel® RAID Controller SRCSAS18E to a Hard Disk Drive.....	15
Figure 7. RAID Controller SRCSAS18E to an Expander Board.....	16
Figure 8. Card Layouts.....	19

Tables

Table 1. Intel® RAID Controller SRCAS18E Overview	8
Table 2. Jumper Descriptions	19
Table 3. Card Characteristics	20
Table 4. Specifications	21
Table 5. Array Performance Features	22
Table 6. Fault Tolerance Features	22
Table 7. Electrical Characteristics	23

1 Overview

This chapter provides a general overview of the Intel® RAID Controller SRCSAS18E with RAID control capabilities. It consists of the following sections:

- SAS Controller Description
- Configuration Scenarios
- Benefits of SAS
- Summary of SAS RAID Controller Features
- Hardware Specifications

The RAID Controller SRCSAS18E Storage Adapter is a high-performance intelligent PCI Express*-to-SAS adapter with RAID control capabilities. The RAID Controller SRCSAS18E provides reliability, high performance, and fault-tolerant disk subsystem management. This is an ideal RAID solution for the internal storage of workgroup, departmental, and enterprise systems. The RAID Controller SRCSAS18E offers a cost-effective way to implement RAID in a server.

The SAS controller allows you to use SATA and SAS hard disk drives in the same system, so you can take advantage of the benefits of each type of drive. Each controller can connect up to eight drives directly and use expanders to connect to additional drives. See the ANSI SAS standard, version 1.0 specification for more information about the use of expanders.

As the second generation PCI Express storage adapter, the RAID Controller SRCSAS18E addresses the growing demand for increased data throughput and scalability requirements across midrange and enterprise-class server platforms. Simplified cabling between drives is an additional benefit.

The innovative Intel® Portable Cache Module 2 for cached data protection allows system builders to protect cached data even during the most catastrophic system failures.

The SAS controller supports the ANSI *Serial Attached SCSI standard, version 1.0*. In addition, the controller supports the Serial ATA (SATA) protocol defined by the *Serial ATA specification, version 1.0a*. Supporting both the SAS and SATA interfaces, the SAS controller is a versatile controller that provides the backbone of both server and high-end workstation environments.

Each port on the SAS RAID controller supports SAS and SATA devices using the SAS Serial SCSI Protocol (SSP), Serial Management Protocol (SMP), and Serial Tunneling Protocol (STP). The SSP protocol enables communication with other SAS devices.

SAS Controller Description

The RAID Controller SRCAS18E is available with eight ports via two x4 SFF8484 connectors. The RAID Controller SRCAS18E has one Intel[®] IOP333 I/O processor that controls the SAS interface.

The RAID Controller SRCAS18E brings 3.0 Gbit/s Serial Attached SCSI and 3.0 Gbit/s SATA performance to host adapter, workstation, and server designs. The controller support internal storage devices and allows you to use a system that supports enterprise-class SAS and desktop-class SATA drives.

The SAS controller integrates eight high-performance SAS/SATA phys. Each of the eight phys is capable of 3.0 Gbit/s SAS link rates, and 3.0 Gbit/s SATA link rates.

The SAS RAID controller supports the SAS protocol as described in the *Serial Attached SCSI Standard, version 1.0*, as well as SAS 1.1 features. The controller also supports the Serial ATA protocol defined by the *Serial ATA specification, version 1.0a*. In addition, the SAS RAID controller supports the following SATA features:

- 3 Gbit/s SATA
- Staggered spin-up
- Hot Plug
- Native Command Queuing (NCQ)

Note: Available with TA D46199-003 or later only.

- Activity and fault indicators per phy
- Port Selector (for dual-port drives)

Each port on the SAS controller supports SAS and SATA devices using the SAS Serial SCSI Protocol (SSP), Serial Management Protocol (SMP), Serial Tunneling Protocol (STP), and SATA. The SSP protocol enables communication with other SAS devices. SATA enables the SAS controller to communicate with other SATA devices. The SAS RAID controller supports a x8 PCI Express interface.

Configuration Scenarios

The following scenerio is an example of how to use the SAS controller on the RAID Controller SRCAS18E:

- Low-end, internal SATA configurations: as a high-end SATA-compatible controller that connects up to eight disks either directly or through a port expander. Enclosure management through out-of-band I2C. Mostly for low end or entry servers
- Midrange internal SAS configurations: like internal SATA configurations, but with high-end disks. Suitable for low- to mid- range servers.

Figure 1 shows a direct-connect configuration.

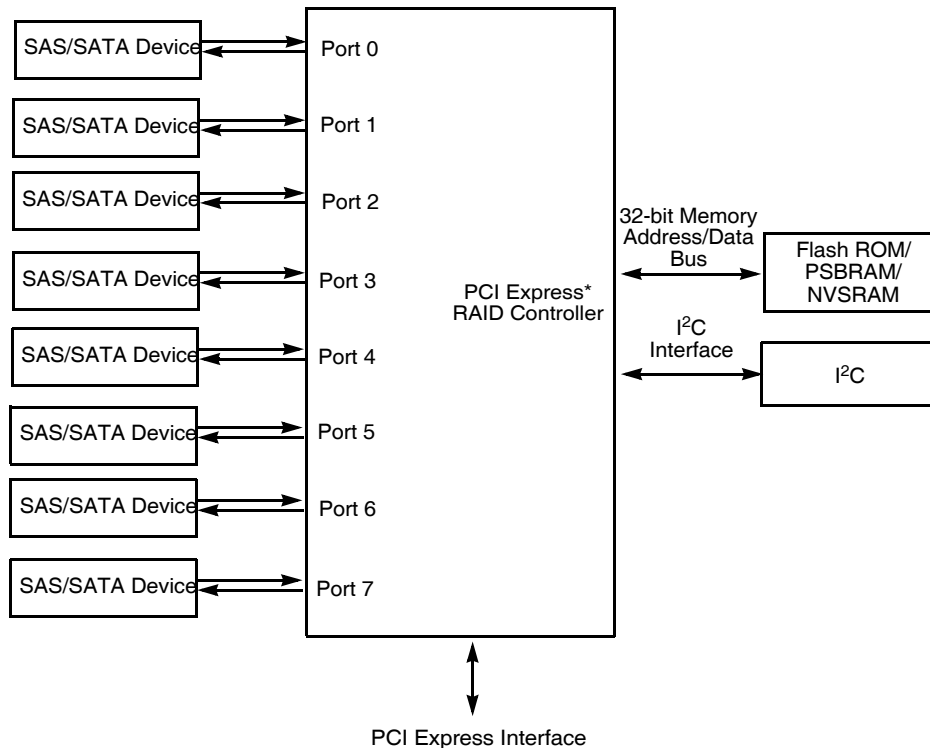

Figure 1. Example Direct-Connect Application

Benefits of SAS

SAS is a serial, point-to-point, enterprise-level device interface that leverages the proven SCSI protocol set. SAS is a convergence of the advantages of SATA, SCSI, and FC, and is the future mainstay of the enterprise and high-end workstation storage markets. SAS offers a higher bandwidth per pin than parallel SCSI, and improves signal and data integrity.

The SAS interface uses the proven SCSI command set to ensure reliable data transfers, while providing the connectivity and flexibility of point-to-point serial data transfers. The serial transmission of SCSI commands eliminates clock skew challenges. The SAS interface provides improved performance, simplified cabling, smaller connectors, lower pin count, and lower power requirements when compared to parallel SCSI.

SAS controllers leverage a common electrical and physical connection interface that is compatible with Serial ATA technology. The SAS and SATA protocols use a thin, 7-wire connector instead of the 68-wire SCSI cable or 40-wire ATA cable. The SAS/SATA connector and cable are easier to manipulate, allow connections to smaller devices, and do not inhibit airflow. The point-to-point SATA architecture eliminates inherent difficulties created by the legacy ATA master-slave architecture, while maintaining compatibility with existing ATA firmware.

PCI Express* Architecture

PCI Express is a local bus system designed to increase data transfers without slowing down the central processing unit (CPU). You can install the RAID Controller SRCAS18E in a PCI Express computer system that has a standard bracket type. With this adapter in your system, you can connect SAS and SATA devices over the bus.

PCI Express goes beyond the PCI specification in that it is intended as a unifying I/O architecture for various systems: desktops, workstations, mobile, server, communications, and embedded devices.

Operating System Support

The RAID Controller SRCAS18E supports major operating systems, such as:

- Windows 2000*, Windows Server 2003*, and Windows XP*
- Red Hat* Enterprise Linux 3.0 and 4.0
- SuSe* Linux 9.0 and 9 SP1

Note: The operating systems supported by this controller may not be supported by your server board. See the tested operating system list for your server board at <http://support.intel.com/support/motherboards/server/>. See also the tested hardware and operating system list for the RAID Controller SRCAS18E to make sure the RAID card supports your operating system.

Summary of SAS RAID Controller Features

This section provides a summary of the features and benefits of the SAS RAID controller. It contains information on SAS features, SATA features, PCI performance, integration, usability, and flexibility.

Features of the RAID Controller SRCAS18E include:

- Online RAID level migration
- Drive migration
- Drive roaming
- No reboot necessary after expansion
- More than 200 Qtags per array
- Hardware clustering support on the board
- User-specified rebuild rate
- Performance up to 2.5 Gbits/s per lane, PCI Express* x8
- Support for a 256 DDR2 400 MHz SDRAM DIMM portable cache module, providing battery backup of data in transit (Intel accessory AXXRPCM2)

- Two internal connectors
- Support for RAID levels 0, 1, 5, 10, and 50
- Advanced array configuration and management utilities
- 32 Kbyte NVRAM for storing RAID system configuration information; the firmware is stored in flash ROM for easy upgrades.

SAS Features

The following list describes the SAS features:

- Provides eight fully independent phys
- Each phy supports 3.0 Gbit/s and 1.5 Gbit/s SAS data transfers
- Supports SSP to enable communication with other SAS devices
- Supports SMP to communicate topology management information
- Provides a serial, point-to-point, enterprise-level storage interface
- Simplifies cabling between devices
- Provides a scalable interface that supports up to 128 devices through multiple expanders
- Supports wide ports consisting of 2, 3, or 4 phys within a single quad port
- Supports narrow ports consisting of a single phy
- Transfers data using SCSI information units

SATA Features

The following list describes the SATA features:

- Supports SATA data transfers of 3.0 Gbits/s and 1.5 Gbits/s
- Supports STP data transfers of 3.0 Gbits/s and 1.5 Gbits/s
- Provides a serial, point-to-point storage interface
- Simplifies cabling between devices
- Eliminates the master-slave construction used in parallel ATA
- Allows addressing of multiple SATA targets through an expander if using SATA 2.0-compliant hard disk drives
- Allows multiple initiators to address a single target (in a fail-over configuration) through an expander

PCI Performance

This RAID controller uses an Intel[®] IOP333 500 MHz I/O processor.

Usability

The following list describes the usability features.

- Simplifies cabling with point-to-point, serial architecture
- Smaller, thinner cables do not restrict airflow
- Provides drive spin-up sequencing control
- Provides an Inter-IC (I²C) interface for enclosure management

Flexibility

These features increase the flexibility of the SAS RAID controller.

- Supports a Flash ROM interface, a nonvolatile RAM (NVSRAM) interface
- Offers a flexible programming interface to tune I/O performance
- Allows mixed connections to SAS or SATA targets
- Leverages compatible connectors for SAS and SATA connections

Drive Roaming

Drive roaming occurs when the hard drives are changed to different ports on the same controller. When the drives are placed on different ports, the controller detects the RAID configuration from the configuration data on the drives.

Note: If you move a drive that is currently being rebuilt, the rebuild operation will restart, not resume.

Perform the following steps to use drive roaming:

1. Turn off all power to the server and all hard drives, enclosures, and system components, then disconnect power cords from the system.
2. Open the host system, following the instructions in the host system technical documentation.
3. Move the drives to different positions on the backplane to change the targets.
4. Determine the SAS target requirements.
5. Perform a safety check.
 - Make sure the drives are inserted properly.
 - Close the cabinet of the host system.
 - Turn power on after completing the safety check.
6. Power on the system.

The controller detects the RAID configuration from the configuration data on the drives.

Drive Migration

Drive migration is the transfer of a set of hard drives in an existing configuration from one controller to another. The drives must remain on the same port and be reinstalled in the same order as in the original configuration. The controller to which you migrate the drives cannot have an existing configuration.

Note: Only complete configurations can be migrated; individual virtual disks cannot be migrated.

Note: Drive roaming and drive migration cannot be supported at the same time.

Perform the following steps to migrate drives:

1. Make sure that you clear the configuration on the system to which you migrate the drives, to prevent a configuration data mismatch between the hard drives and the NVRAM.
2. Turn off all power to the server and all hard drives, enclosures, and system components, then disconnect power cords from the systems.
3. Open the host systems by following the instructions in the host system technical documentation.
4. Remove the SAS cable connectors from the internal drives or the shielded cables from the external drives you want to migrate.
 - Make sure pin 1 on the cable matches pin 1 on the connector.
 - Make sure that the SAS cables conform to all SAS specifications.
5. Remove the hard drives from the first system and insert them into drive bays on the second.
6. Connect the SAS cables to the hard drives in the second system in the same order as they were connected in the first system.
7. Determine the SAS target requirements.
8. Perform a safety check.
 - Make sure all cables are properly attached.
 - Make sure the RAID controller is properly installed.
 - Close the cabinet of the host system.
 - Turn power on after completing the safety check.
9. Power on the system.

The controller detects the RAID configuration from the configuration data on the drives.

Hardware Specifications

You can install the RAID Controller SRCAS18E in a computer with a server board that has a x8 PCI Express* slot.

Table 1 provides an overview of the RAID Controller SRCAS18E.:

Table 1. Intel® RAID Controller SRCAS18E Overview

Specification	Intel® RAID Controller SRCAS18E
RAID Levels	0, 1, 5, 10, 50
Devices per Port	Up to 15 drives / devices per port
Ports	Two internal connectors that support up to four ports per connector
Data Transfer Rate	Up to 3 Gbits/s per port
Cache Function	Write-back, Write-through, Adaptive Read Ahead, Non-Read Ahead, Read Ahead, Cache I/O, Direct I/O
Multiple Logical Drives/Arrays per Controller	Up to 40 logical drives per controller or per logical array
Online Capacity Expansion	Yes
Dedicated and Global Hot Spares	Yes
Hot Swap Devices Supported	Yes
Non-Disk Devices Supported	Yes
Mixed Capacity Hard Disk Drives Supported	Yes
Number of x4 SAS Connectors	2
Cluster Support	No
Hardware Exclusive OR (XOR) Assistance	Yes
Direct I/O	Yes

2 Intel® RAID Controller SRCSAS18E Hardware Installation

This chapter describes the procedures used to install the Intel® RAID Controller SRCSAS18E with internal and external connectors. It contains the following sections:

- Requirements
- Quick Installation
- Detailed Installation
- SAS Device Cables
- Replacing a Failed Controller that Contains Data in the Intel® RAID Portable Cache Module 2
- After Installing the Storage Adapter

Requirements

The following items are required to install a RAID Controller SRCSAS18E:

- An Intel® RAID Controller SRCSAS18E
- A host system with an available x8 PCI Express* expansion slot
- The *Resource CD*, which contains drivers and documentation
- The necessary internal cables
- SAS or SATA hard disk drives

Intel Corporation strongly recommends using an uninterruptible power supply (UPS).

Quick Installation

The following steps are for quick RAID Controller SRCAS18E installation. These steps are for experienced computer users/installers. “Detailed Installation” contains the steps for all others to follow.

1. Turn power off to the system and all hard disk drives, enclosures, and system components.
2. Remove the power cord from the server.
3. Follow the instructions in the server documentation to open the server chassis.
4. Check the jumper settings and memory module on the RAID controller.
5. Install the RAID Controller SRCAS18E in the server and connect SAS or SATA devices to it. Ensure that the cables you use conform to all specifications.
6. Perform a safety check.
 - Ensure that all cables are properly attached.
 - Ensure that the RAID Controller SRCAS18E is properly installed.
 - Close the server chassis.
7. Reconnect power cable and turn on power.

Detailed Installation

This section provides detailed instructions for installing a RAID Controller SRCAS18E.

1. Unpack the Storage Adapter

Unpack and remove the RAID Controller SRCAS18E. Inspect it for damage. If it appears damaged, or if any items listed below are missing, contact your Intel sales representative. The RAID Controller SRCAS18E is shipped with:

 - The *Resource CD*, which contains drivers for supported operating systems, an electronic version of this *User's Guide*, and other related documentation
 - A license agreement
2. Power Down the Server

Turn off the computer and remove the AC power cord. Remove the server chassis cover. Refer to the server documentation for instructions.
3. Check the Jumpers

Ensure that the jumper settings on the your RAID Controller SRCAS18E are correct. See Chapter 3 for a diagrams of the RAID Controller SRCAS18E.

Note: The jumpers are set at the factory and probably do not need to be changed.

4. Check the Memory Module

Ensure that the memory module or Intel® RAID Portable Cache Module 2 is present and seated firmly in the DIMM socket.

5. Install the RAID Controller SRCSAS18E

Select a x8 PCI Express* slot and align the controller's PCI Express bus connector to the slot. Press down gently but firmly to ensure that the card is properly seated in the slot, as shown in Figure 2. Secure the bracket to the computer chassis.

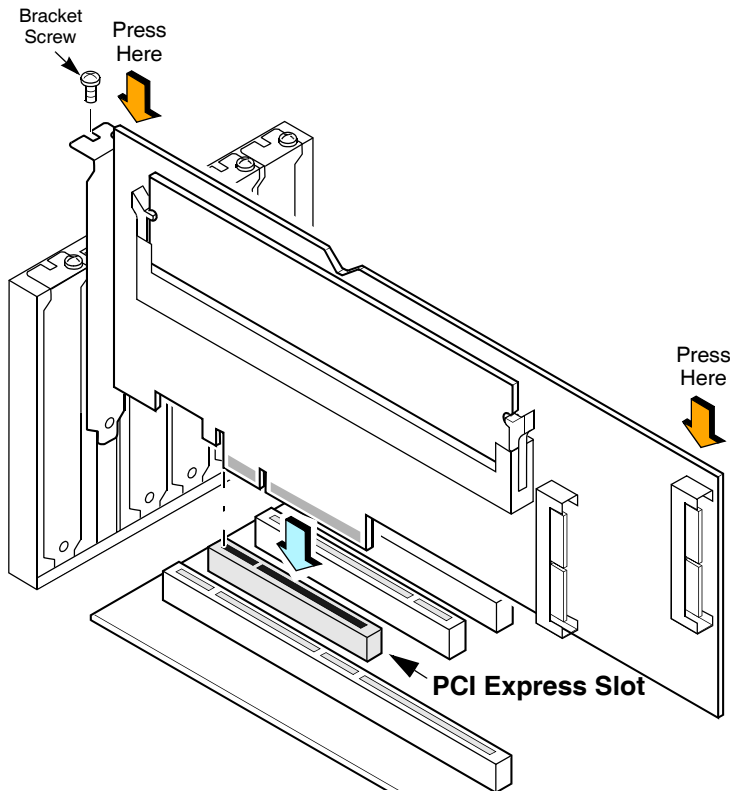

Figure 2. Inserting the Intel® RAID Controller SRCSAS18E Card in a PCI Express* Slot

6. Connect SAS or SATA Devices to the Storage Adapter

Use SAS cables to connect SAS or SATA devices to the RAID Controller SRCSAS18E. See “SAS Features“ on page 5 and “SAS Device Cables“ on page 12 for SAS cable information. See “Connecting the SAS RAID Controller to Hard Disk Drives and Expanders“ on page 15 for details about connecting the controller to hard disk drives and expanders.

Note: System throughput problems can occur if using SAS cables that do not come with the RAID controller and that are not the correct type. To minimize the potential for problems:

- *Use cables no longer than ten meters for SAS and one meter for SATA. It is better to use the shortest possible cables. The cable length should be reduced by about one foot (.33 meters) if using a backplane.*
- *You may connect one device per SATA/SAS cable either as a device or as an expander.*
- *Route SAS cables carefully*
- *Use only “straight” SAS cables, not “cross-over” SAS cables.*

7. Power On Server

Replace the chassis cover and reconnect the AC power cord(s). Power up the SAS and SATA devices before or at the same time as the server. If the computer is powered up before a SAS or SATA device, the device might not be recognized.

During the boot, a BIOS message appears. The firmware takes several seconds to initialize.

The configuration utility prompt times out after several seconds. The second portion of the BIOS message displays the RAID Controller SRC SAS18E number, firmware version, and cache SDRAM size. The numbering of the controllers follows the PCI slot scanning order used by the host mainboard.

If you want to run the BIOS Console 2 utility, press the appropriate keys when this message appears:

Press <CTRL><G> to run BIOS Console 2

SAS Device Cables

This section describes the cables used on the SAS controller and provides step-by-step instructions for connecting SAS and SATA hard disk drives to the SAS RAID controller. The SAS and SATA protocols use a thin, 7-wire connector.

Note: Use only “straight” SAS cables, not “cross-over” SAS cables.

Figure 3 displays the SAS cable used to connect the internal connectors on a SAS RAID controller to SAS drives.

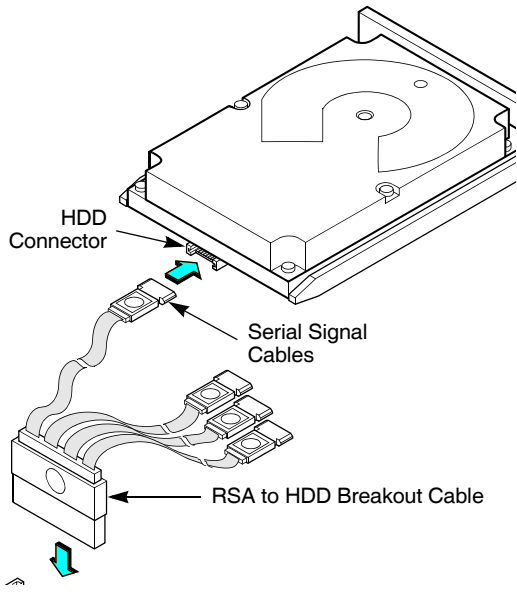

Figure 3. Internal SAS Cable for Connection to SAS and SATA Hard Disk Drives

Figure 4 displays the SATA device plug connector used to connect a SAS RAID controller with internal connector to the host receptacle connector on a backplane. A SATA connector consists of a signal connector and a power connector.

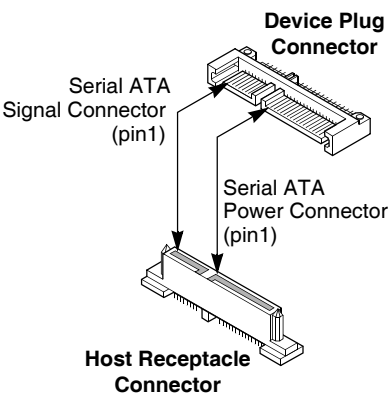

Figure 4. Serial ATA Connectors

Figure 5 show SAS and SATA connectors on SAS and SATA hard disk drives, respectively. Cables are used for connection between internal connectors on the RAID controller and connectors on SAS and SATA drives, respectively. Both SAS and SATA hard disk drives can connect to SAS backplane receptable connectors. The difference between the SAS connector and SATA connector is the bridge between the SAS primary physical link and power connector on the SAS controller.

*Note: SAS backplane connectors can accept SAS or SATA hard disk drives, but SATA backplane connectors **cannot** accept SAS drives.*

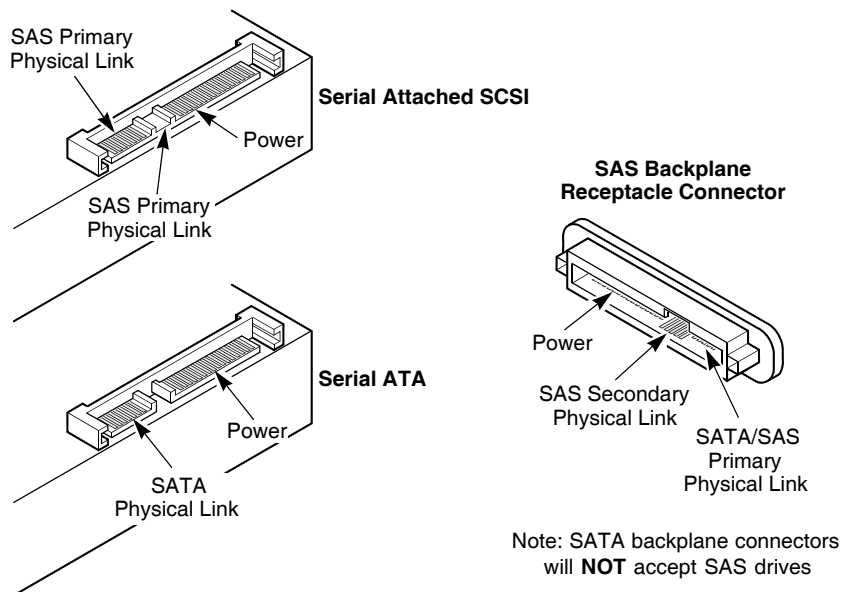

Figure 5. SAS and SATA Plugs and SAS Backplane Receptacle Connector

Connecting the SAS RAID Controller to Hard Disk Drives and Expanders

This section provides step-by-step instructions for connecting the SAS RAID controller to SAS backplane or SATA hard disk drives, either directly or through an expander. The figures in this section show the RAID Controller SRCAS18E connected to hard disk drives and to expanders, which then connect to hard disk drives.

Figure 6 displays the SAS cables used to connect the RAID Controller SRCAS18E to a hard disk drive.

Perform the following steps to connect a RAID Controller SRCAS18E directly to the SAS backplane or SATA hard disk drives, as shown in Figure 6.

1. Plug the 7-wire connector on the internal cable into the connector on a SAS RAID controller.
2. Plug the connector on the other end of the cable into the connector on a SAS backplane or SATA hard disk drive.
3. If you have another hard disk drive, connect it to another plug on the cable.

You can connect other devices if the cable has more connectors.

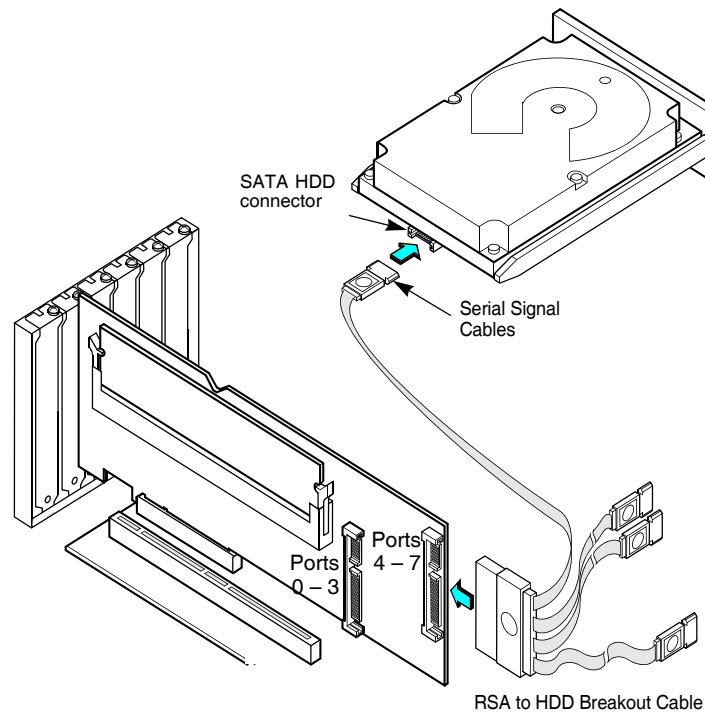

Figure 6. Intel® RAID Controller SRCAS18E to a Hard Disk Drive

Note: The cable provided connects directly only to SATA drives and SAS backplanes. SAS drive manufacturers use a small plastic key ring between the data and power connectors. This requires a different connector (not provided).

Figure 7 displays the SAS cables used to connect the RAID Controller SRCSAS18E to an expander board. Perform the following steps to connect a RAID Controller SRCSAS18E to an expander board, as shown in Figure 7.

1. Plug the 7-wire connector on the cable into the connector on a SAS RAID controller.
2. Plug the connector on the other end of the cable into the connector on an expander board.

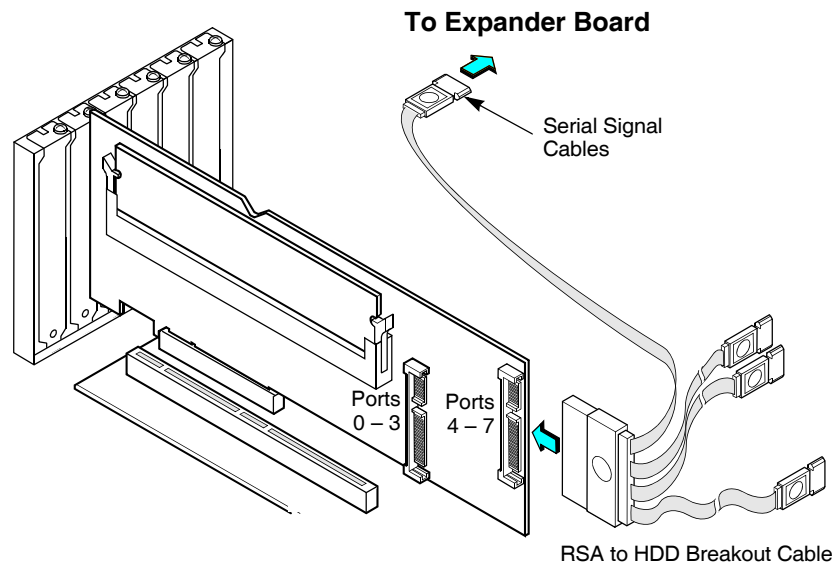

Figure 7. RAID Controller SRCSAS18E to an Expander Board

Replacing a Failed Controller that Contains Data in the Intel® RAID Portable Cache Module 2

The Intel® RAID Portable Cache Module 2 (AXXRPCM2) is a cache memory module with an integrated battery pack. The module provides an uninterrupted power source to the module if power is unexpectedly interrupted while cached data is still present. If the power failure is the result of the RAID Controller SRCSAS18E itself failing, then the Intel® RAID Portable Cache Module 2 can be moved to a new controller and the data recovered. The replacement controller must have a cleared configuration.

Perform the following steps to replace a failed controller with data in the transportable battery backup unit.

1. Power-down the system and drives.
2. Remove the failed controller from the system.
3. Remove the Intel® RAID Portable Cache Module 2 from the failed controller.
4. Insert the new Intel® RAID Portable Cache Module 2 into the replacement controller.
5. Connect the battery cable to the connector on the Intel® RAID Portable Cache Module 2,
6. Insert the replacement controller into the system.
7. Power-on the system. The controller then reads the disk configuration into NVRAM and flushes cache data to the logical drives.

Resolving a Configuration Mismatch – If the replacement controller has a previous configuration, a message displays during the power-on self-test (POST) stating that there is a configuration mismatch. A configuration mismatch occurs when the configuration data in the NVRAM and the hard disk drives are different. You need to update the configuration data in the NVRAM with the data from the hard disk drive.

Perform the following steps to resolve the mismatch.

1. Press <Ctrl> <G> when prompted during bootup to access the BIOS Configuration Utility.
2. Select Configure—>View/Add Configuration.
3. This gives you the option to view the configuration on both the NVRAM and the hard drive disk.
4. Select the configuration on disk.
5. Press <Esc> and select YES to update the NVRAM.
6. Exit and reboot.

After Installing the Storage Adapter

After RAID Controller SRCAS18E installation, you must configure the storage adapter and install the operating system driver. The *Software User's Guide* instructs you on the configuration options and how to set them on your RAID Controller SRCAS18E, and provides detailed installation instructions for operating system drivers.

3 Intel® RAID Controller SRCAS18E Characteristics

This chapter describes the characteristics of the Intel® RAID Controller SRCAS18E.

The Intel® RAID Controller SRCAS18E is a dual phys SAS PCI Express* storage adapter that is used in a system with a PCI Express slot. PCI Express goes beyond the PCI specification in that it is intended as a unifying I/O architecture for various systems: desktops, workstations, mobile, server, communications, and embedded devices.

Figure 8 displays the connectors and headers on the controller and Table 2 describes them.

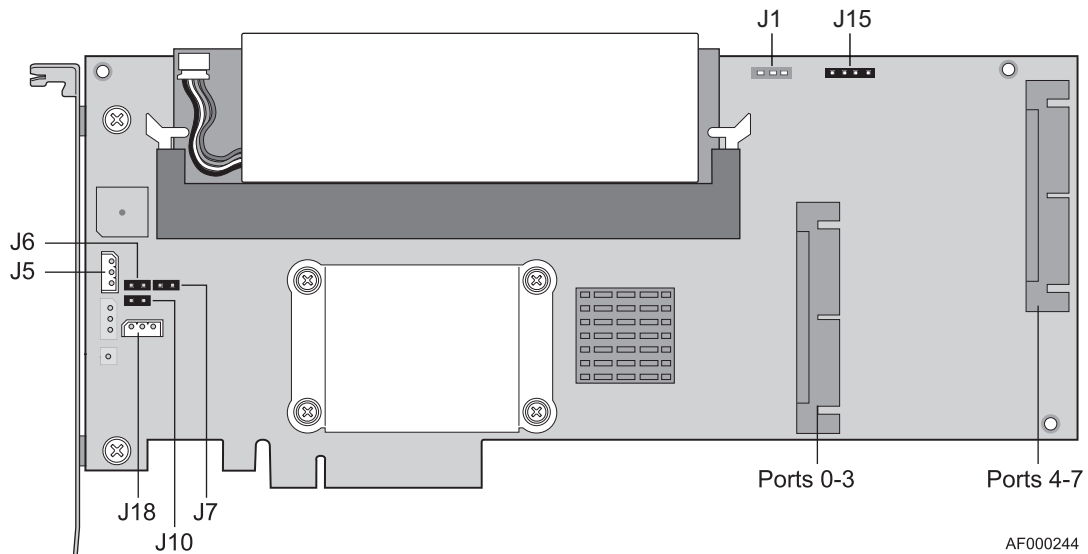

Figure 8. Card Layout

Table 2. Jumper Descriptions

Jumper	Description	Type	Comments
J1	UART	3-pin connector	Factory debug use only.
J5	I ² C SAF-TE	3-pin keyed connector	SAF-TE OOB enclosure management. Warning: Do not connect to a non-expander SAS backplane. Doing so may cause data loss.
J6	BIOS disable	2-pin connector	No jumper: Uses BIOS determination (default). Jumper installed: BIOS is disabled.

Table 2. Jumper Descriptions

Jumper	Description	Type	Comments
J7	Set Mode 0	2-pin connector	Mode 0 holds the I/O processor in reset to allow firmware recovery. No jumper: Normal operational mode. Jumper: Mode 0 for firmware recovery. Requires a firmware recovery utility and firmware image file.
J10	Dirty cache LED	2-pin connector	Connect to enclosure LED to indicate data in cache has not been written to disk.
J15	Debug header	4-pin connector	Factory debug use only
J18	I ² C SES2	4-pin keyed connector	SES2 OOB enclosure management

Characteristics

Table 3 shows the general characteristics for the RAID Controller SRCSAS18E.

Table 3. Card Characteristics

Flash ROM ¹	SAS Data Transfers	NVRAM	SATA2 Features	SAS Features	SAS 1.0	SAS 1.1	SATA 1.0
Yes	Up to 3 Gbits/s per lane	Yes	<ul style="list-style-type: none"> • 3 Gbits/s SATA • Staggered spin-up • Hot-plug • Native command queing (NCQ)² • Activity and fault indicators • Port selector 	PSP, SMP, STD	Yes	Yes	Yes

1. For boot code and firmware.

2. NCQ is available only with TA D46199-003 or later.

The RAID Controller SRCSAS18E ensures data integrity by intelligently validating the compatibility of the SAS domain.

Technical Specifications

The design and implementation of the RAID Controller SRCSAS18E minimizes electromagnetic emissions, susceptibility to radio frequency energy, and the effects of electrostatic discharge. The storage adapter carries the CE mark, C-Tick mark, FCC Self-Certification logo, Canadian Compliance Statement, Korean MIC, Taiwan BSMI, and Japan VCCI, and they meet the requirements of CISPR Class B.

Table 4 lists the specifications for the RAID Controller SRCSAS18E.

Table 4. Specifications

Specification	Intel® RAID Controller SRCSAS18E
Processor (PCI Controller)	Intel® 80333 I/O processor at 500 MHz
Operating Voltage	+3.3 V, +12 V
Card Size	Standard height, full-length PCI Express adapter card size (4.376" x 9.5")
Array Interface to Host	PCI Express* Rev 1.0A
PCI Express Bus Data Transfer Rate	x8 lane widths at 2.5 Gigabits
Serial Port	3-pin RS232-compatible connector (for manufacturing use only)
SAS Controller(s)	One LSI SAS 1068 Single SAS controller
SAS Bus Speed	3 GBits/s
SAS Ports	2x4 internal ports
Cache Configuration	Integrated 256 MB DDR2 400 MHz SDRAM included. Intel® RAID Portable Cache Module 2 with 256 MB is available as an optional accessory.
Double-Sided Dual Inline Memory Modules (DIMMs)	Yes
Size of Flash ROM for Firmware	8 Mbyte flash ROM
Nonvolatile Random Access Memory (NVRAM)	32 Kbytes for storing RAID configuration

Array Performance Features

Table 5 shows the RAID Controller SRCAS18E array performance features.

Table 5. Array Performance Features

Specification	Intel® RAID Controller SRCAS18E
PCI Express* Host Data Transfer Rate	2.5 Gigabit/s per lane
Drive Data Burst Rate	3 Gigabit/s per port or 300 MB/s
Maximum Scatter/Gathers	26 elements
Maximum Size of I/O Requests	6.4 Mbytes in 64 Kbyte stripes
Maximum Queue Tags per Drive	As many as the drive can accept
Stripe Sizes	8, 16, 32, 64, or 128 Kbyte
Maximum Number of Concurrent Commands	255
Support for Multiple Initiators	Yes

Fault Tolerance

Table 6 shows the RAID Controller SRCAS18E fault tolerance features.

Table 6. Fault Tolerance Features

Specification	Intel® RAID Controller SRCAS18E
Support for SMART ¹	Yes.
Optional Battery Backup for Cache Memory	Intel® RAID Portable Cache Module 2 battery backup. 4.8V/880mAH battery pack. Up to 72 hours of data retention for 256 MB.
Drive Failure Detection	Automatic
Drive Rebuild Using Hot Spares	Automatic
Parity Generation and Checking	Yes

1. The Self Monitoring Analysis and Reporting Technology (SMART) detects up to 70 percent of all predictable disk drive failures. In addition, SMART monitors the internal performance of all motors, heads, and drive electronics.

Electrical Characteristics

This section provides the power requirements for the RAID Controller SRCSAS18Es. Table 7 lists the maximum power requirements.

Table 7. Electrical Characteristics

Storage Adapter	PCI / PCI Express* / Express +12 V	PCI / PCI Express +5.0 V	PCI / PCI Express / Express+3.3 V	PCI PRSNT1# / PRSNT2# Power	Operating Range
RAID Controller SRCSAS18E	115 mA; used only if battery is present	1.5 A (PCI only)	N/A	15 W	0 °C to 55 °C

Thermal and Atmospheric Characteristics

For the Intel® RAID Controller SRCSAS18E, the thermal and atmospheric characteristics are:

- Relative humidity range: 5% to 90% non-condensing
- Maximum dew point temperature: 32 °C
- Airflow must be at least 300 linear feet per minute (LFPM) to avoid operating the 80333 processor above the maximum ambient temperature

The following parameters define the storage and transit environment for the RAID Controller SRCSAS18E:

- Temperature range: 40 °C to +105 °C (dry bulb)

Note: The maximum operating temperature decreases to +45 °C when the Intel® RAID Portable Cache Module 2 battery backup unit is installed.

- Relative humidity range: 5% to 90% non-condensing

Note: The maximum operating temperature decreases to +45 °C when the Intel® RAID Portable Cache Module 2 battery backup unit is installed.

Safety Characteristics

The RAID Controller SRCSAS18E meets or exceeds the requirements of UL flammability rating 94 V0. Each bare board is also marked with the supplier name or trademark, type, and UL flammability rating. For the boards installed in a PCI bus slot, all voltages are lower than the SELV 42.4 V limit.

A Glossary of Terms and Abbreviations

BIOS	Basic Input/Output System. Software that provides basic read/write capability. Usually kept as firmware (ROM based). The system BIOS on a server board is used to boot and control the system. The BIOS on your host adapter acts as an extension of the system BIOS.
Configuration	The way a computer is setup; the combined hardware components (computer, monitor, keyboard, and peripheral devices) that make up a computer system, and the software settings that allow the hardware components to communicate with each other.
Device Driver	A program that allows a microprocessor (through the operating system) to direct the operation of a peripheral device.
Domain Validation	A software procedure in which a host queries a device to determine its ability to communicate at the negotiated data rate.
EEPROM	Electrically Erasable Programmable Read-Only Memory. A memory chip typically used to store configuration information. It provides stable storage for long periods without electricity and can be reprogrammed. See NVRAM.
External SAS Device	A SAS device installed outside the computer cabinet. These devices are connected together using specific types of shielded cables.
Host	The computer system in which a storage adapter is installed. It uses the storage adapter to transfer information to and from devices attached to the SCSI bus.
Host Adapter Board (HAB)	A circuit board or integrated circuit that provides a device connection to the computer system.
Internal SAS Device	A SAS device installed inside the computer cabinet. These devices are connected together using an unshielded ribbon cable.
Main Memory	The part of a computer's memory which is directly accessible by the CPU (usually synonymous with RAM).
NVRAM	Non-volatile Random Access Memory. An EEPROM (Electrically Erasable Read-Only Memory chip) used to store configuration information. See EEPROM.
Peripheral Devices	A piece of hardware (such as a video monitor, disk drive, printer, or CD-ROM) used with a computer and under the computer's control. SCSI peripherals are controlled through a SAS Intel® RAID Controller SRCAS18E.

SAS

Serial Attached SCSI. A serial, point-to-point, enterprise-level device interface that leverages the proven SCSI protocol set. The SAS interface provides improved performance, simplified cabling, smaller connections, lower pin count, and lower power requirements when compared to parallel SCSI. SAS controllers leverage a common electrical and physical connection interface that is compatible with Serial ATA. The SAS controllers support the ANSI *Serial Attached SCSI standard, version 1.0*. In addition, the controller supports the Serial ATA (SATA) protocol defined by the *Serial ATA specification, version 1.0a*. Each port on the SAS RAID controller supports SAS and SATA devices.

SAS Device

Any device that conforms to the SAS standard and is attached to the SAS bus by a SAS cable. This includes SAS storage adapters (host adapters) and SAS peripherals.