Copyright and Warranty Notice

The information in this document is subject to change without notice and does not represent a commitment on part of the vendor, who assumes no liability or responsibility for any errors that may appear in this manual.

No warranty or representation, either expressed or implied, is made with respect to the quality, accuracy or fitness for any particular part of this document. In no event shall the manufacturer be liable for direct, indirect, special, incidental or consequential damages arising from any defect or error in this manual or product.

Product names appearing in this manual are for identification purpose only and trademarks and product names or brand names appearing in this document are the property of their respective owners.

This document contains materials protected under International Copyright Laws. All rights reserved. No part of this manual may be reproduced, transmitted or transcribed without the expressed written permission of the manufacturer and authors of this manual.

If you do not properly set the audio card settings causing the audio card to malfunction or fail, we cannot guarantee any responsibility.

ABIT Home Theater AU10 Plus

5.1 Channel Audio Card User's Manual

Index

CHAPTER 1. GETTING STARTED.....	1-1
1-1. KEY FEATURES	1-1
1-2. FEATURES AND BENEFITS	1-2
1-3. WHAT'S IN THE BOX? (PACKAGE LIST)	1-3
CHAPTER 2. HARDWARE INSTALLATION.....	2-1
2-1. CARD INSTALLATION	2-1
2-2. CARD LAYOUT	2-2
2-3. S/PDIF CONNECTION.....	2-3
2-4. REMOTE CONTROL CONNECTION (OPTIONAL).....	2-4
2-5. "G9 TO 6CH ADAPTER CABLE" CONNECTION	2-8
CHAPTER 3. DRIVER INSTALLATION.....	3-1
3-1. WINDOWS 98/ME	3-1
3-2. WINDOWS 2000	3-3
3-3. WINDOWS XP	3-6
CHAPTER 4. UTILITY SETUP	4-1
4-1. THE WINDVD.....	4-1
4-2. THE WINRIP.....	4-4
4-3. YAMAHA SOFTSYNTHESIZER.....	4-12
4-4. THE DIRECTX	4-16
APPENDIX A. PRODUCT FAQ.....	A-1
APPENDIX B. HOW TO GET TECHNICAL SUPPORT.....	B-1



Chapter 1. Getting Started

Congratulations! You have chosen one of the most powerful high performance 3D audio cards available. In this chapter we will show you the key features, features and benefits, and the package list of ABIT Home Theater AU10 audio card.

1-1. Key Features

- ForteMedia FM801-AU audio controller
- 5.1 channel output
- PCI 2.1 Compliant
- Soft MPEG-II Support
- Microsoft DirectSound and MMSYSTEM Compliance
- 128-voice Software WaveTable Synthesizer support
- Superior 3D positional Audio Support
- Creative Environmental Audio (EAX), A3D 1.0 game titles Compatible
- Native DOS Game Support without Software Emulation
- Analog/Digital Joystick Interface
- Legacy Audio compatibility
- Hardware Sound Blaster Pro compatibility
- AdLib compatible Music Synthesizer
- MPU401 UART mode MIDI interface

1-2. Features and Benefits

Yamaha XG

- High-quality sound rivaling CD audio
- Supports the XG format with a rich array of sounds and diverse effects
- Dynamic filtering allows subtle musical nuances to be reproduced
- Simultaneous playback of MIDI and audio is now possible

WinDVD

- The WinDVD is a software DVD decoder/player that capitalizes on the growing demand for DVD playback on the PC. This software DVD decoder/player includes integrated MPEG1 and MPEG2 file playback, a powerful VCD 2.0 player, MP3 audio file and SVCD playback. The Dolby AC-3 and DTS decoding function supports 6-channel output.

Remote Control Kit

- The world's only complete remote control allows you to sit back, relax and enjoy watching your DVDs, listening to the 5.1 channel digital output. Just like your regular TV remote, there is no need to get up in order to control how and what you see and hear.
- The remote control can also be used in the office in controlling your PowerPoint presentations.

Great Sound Clarity

- Provide highest quality of playback and recording performance by separating digital controller (FM801) and CODEC (AC'97).

Sound Accuracy to the Music Notes

- Supports software wavetable synthesizer (music synthesizer engine).

WinRip™

- Provide you with a complete audio playback and recording environment for all currently available audio formats, including the MP3, MP2, WAVE, MIDI, and Audio CD formats for ABIT's 5.1 channel playing device.

3D Positional Sound

- Q3D is the positional 3D sound algorithm provided by QSound. It provides the ability to simulate a two-speaker system as a full surround sound source. It supports Microsoft® direct sound and positional 3D games. That means with this driver, your AU10 PCI audio card can be used to play those amazing games with positional 3D audio.

1-3. What's in the box? (Package List)

Check the following list. If there is any item damaged or missing, please contact your local dealer.

- ☑ (1) AU10 Audio Card
- ☑ (1) G9 to 6ch Adapter Cable
Red jack: Connect to Front Speakers
White jack: Connect to Rear Speakers
Black jack: Connects to Center Speaker/Subwoofer
- ☑ (1) Remote Controller (Optional)
- ☑ (1) Remote Receiver (Optional)
- ☑ (1) CA22 S/PDIF Daughter Board with Cable (Optional)
- ☑ (1) User's Manual
- ☑ (1) AU10 Plus Installation and Utility CD.

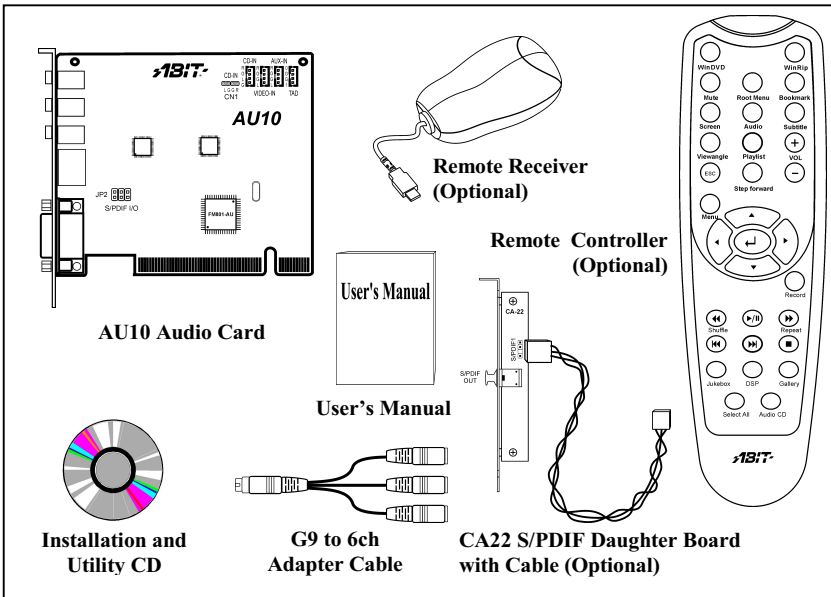



Chapter 2. Hardware Installation

It is fast and easy to install the AU10 audio card. Simply insert this audio card into any empty PCI slot on your motherboard, and then fix it to the back panel.

2-1. Card Installation

1. Power off the PC and all external peripherals connected to it (e.g. printer...etc.). Remove the PC system cover.
2. Locate an empty PCI expansion slot. Remove the metal bracket corresponding to the slot you have chosen. Save the screw.
3. Align the AU10 to the expansion slot. Hold the audio card by its edges and insert the card into the slot without using excessive force or pressing any components on the audio card. Make sure it is firmly and completely fixed into the slot.
4. Secure the AU10 to the expansion slot. Align the notch in the mounting bracket of the audio card with the screw hole in the rear panel of the computer case. Use the screw that you had removed from the metal bracket to secure the audio card in place.
5. Replace the system cover. You are now ready to boot up your PC system.

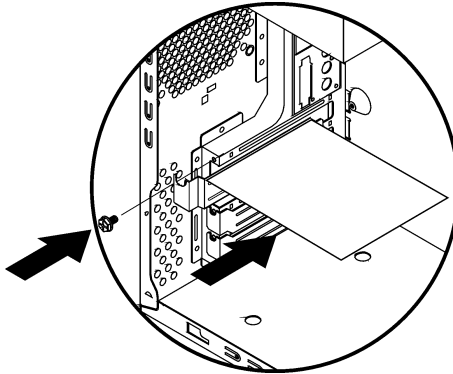

2-2. Card Layout

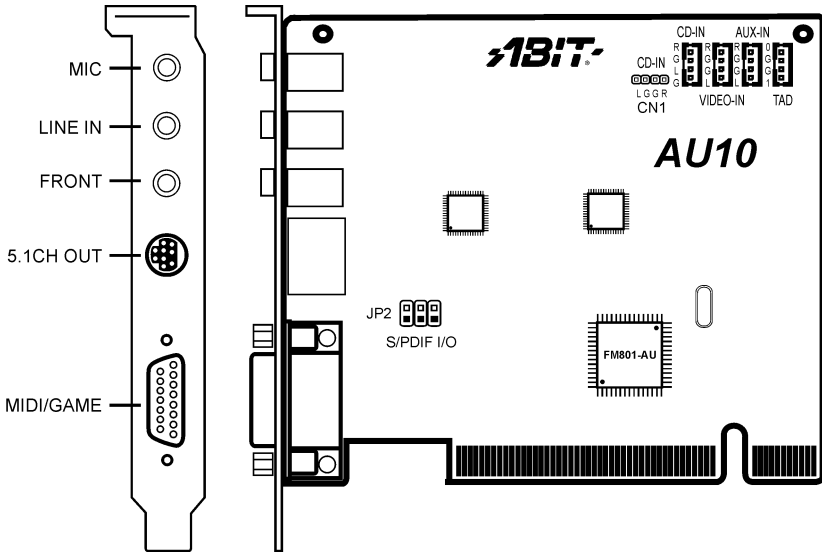

MIC: Connects to microphone.

LINE IN: Connects to external audio source.

FRONT: Connects to 2-speaker audio system.

5.1CH OUT: Connects to 6-speaker audio system.

MIDI/GAME: Connects to MIDI player or Joystick.

CD-IN: Connects to the Audio-Out connector of internal CD/DVD-ROM drive.

VIDEO-IN: Connects to video add-on card.

AUX-IN: Connects to auxiliary audio input.

TAD: Connects to modem card.

S/PDIF I/O: Connects to digital audio.

2-3. S/PDIF Connection

The AU10 Plus equips with a digital output facility through an optional CA-22 daughter card. To set up a digital connection, use the three-threaded cable that came packed together to connect AU10 and CA-22. Please refer to the figure shown below, and pay attention to the orientation of S/PDIF Output Connection on header JP2.

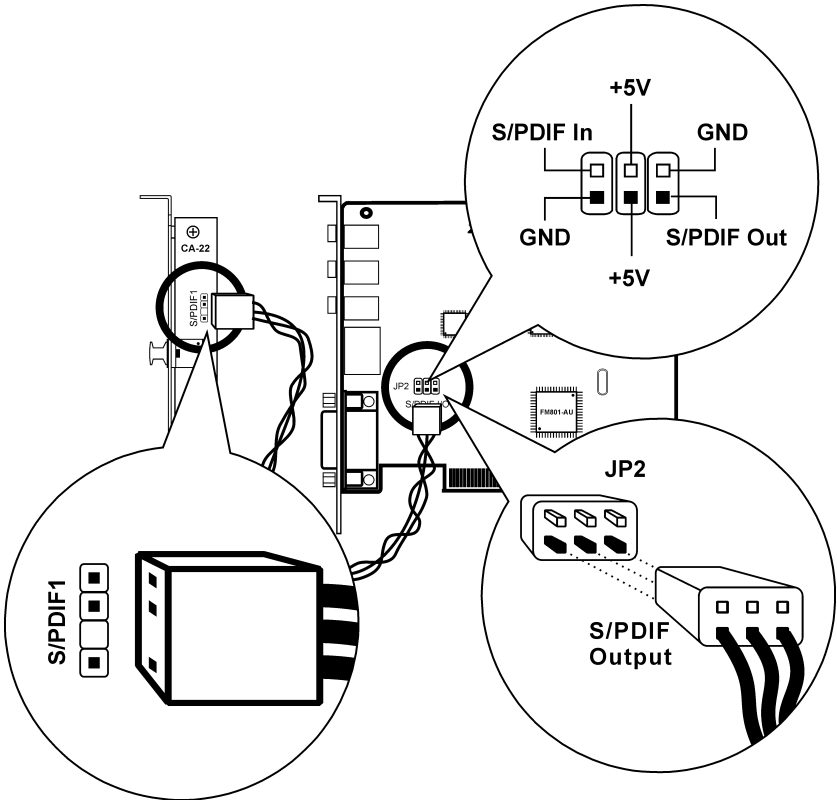

2-4. Remote Control Connection (Optional)

To use the optional remote controller, you have to connect the optional remote receiver to one of the USB ports, which may be found at the back or front panel of your computer. Please refer to the figure shown below.

NOTE: This remote control kit only works with the WinDVD specially designed for audio products from ABIT.

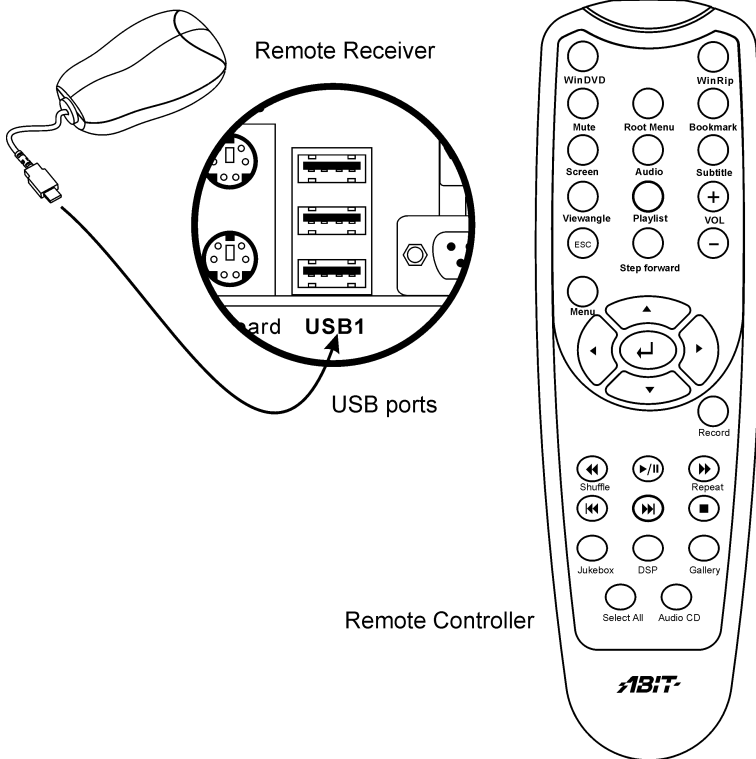



WinDVD Operation:





- **WinDVD:** Execute WinDVD.
- **Mute:** Mutes the sound on the disk currently playing.
- **Root Menu:** Shows the DVD's root menu.
- **Bookmark:** automatically remembers last viewed location of DVDs.
- **Screen:** Select the size of viewing screen.
- **Audio:** Displays the audio track options. If multiple audio tracks or language are available, use this menu to select your choice.
- **Subtitle:** Displays the subtitle menu. If multiple language subtitles are available, use this menu to select your choice.
- **Viewangle:** When available, select the angle to view from a list of optional angles.
- **Playlist:** Opens the Playlist window.
- **VOL +:** Increase audio output.
- **ESC:** To escape from the Menu selection.
- **Step Forward:** Moves to next step in the video.
- **VOL -:** Decrease audio output.
- **Menu:** Shows menu selections.



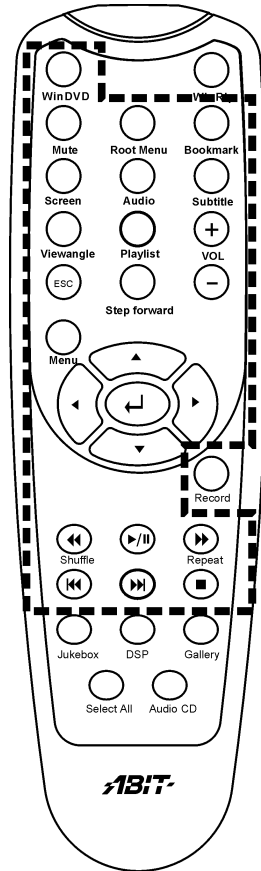





Use these directional buttons just as you would like the mouse button or tab key to do.

- : Enters your selection. This button acts like the Enter key.
- : Plays the disk in fast reverse mode.
- : Plays the current title, pauses the current playback, restores playback after a pause.



- : Plays the disk in fast forward mode.
- : Jump to the previous chapter.
- : Jump to the next chapter.
- : Stops the current playback.

WinRIP Operation:

- **WinRip:** Execute WinRip.
- **VOL +:** Increase audio output.
- **VOL -:** Decrease audio output.
- **Record:** Starts recording the selected track.
- : Shuffles the play and record track order.
- : Plays the current title, pauses the current playback, restores playback after a pause.
- : Replays the song or entire list of songs.
- : Jump to the previous chapter.
- : Plays the disk in fast forward mode.
- : Stops the current playback.
- **JukeBox:** The WinRip JukeBox mode gives the user the ability to Play Audio CD's and Audio files, Record Audio, Organize, Manage and Search for Audio tracks with WinRip's Playlist and Music Gallery features.
- **DSP:** The sound effects to enhance music for various listening environments.
- **Gallery:** It is a database that collects information from the audio files on your system.
- **Select All:** Select all the tracks in the snap-in Area.
- **Audio CD:** Starts playing the Audio CD.

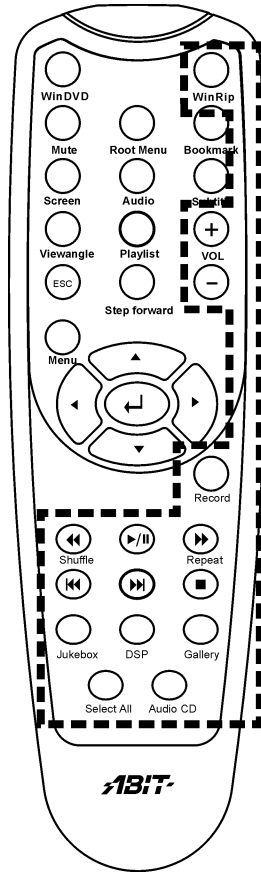

2-5. "G9 to 6ch Adapter Cable" Connection

Please refer to the following figure to set up a 5.1 channel audio system.

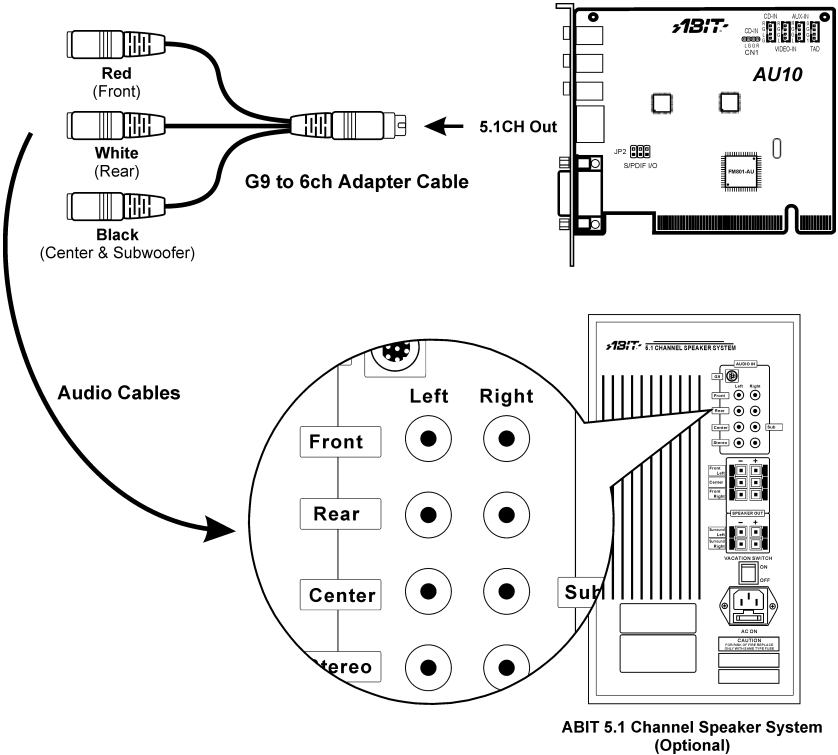

Chapter 3. Driver Installation

3-1. Windows 98/ME

Start Windows. Insert the Installation CD into CD-ROM drive, it should execute the installation program automatically. If not, double-click the execution file at the main directory of this Installation CD to enter the installation menu.



Click “AU10 Driver”.

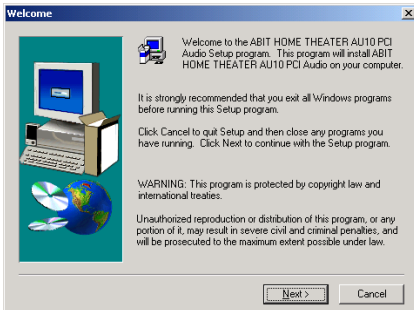

The welcome screen appears, click “Next>” to start installation.



Choose “Yes, I want to restart my computer now”, and then click “Finish” to complete setup.

Speaker Test and Driver Un-Installation

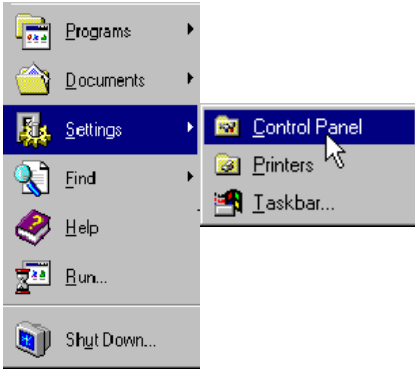

Go to the “Control Panel” by clicking on the “Start” Menu, selecting “Settings” and choosing “Control Panel”.



Double-click on “ABIT Q3D” Icon in “Control Panel”.

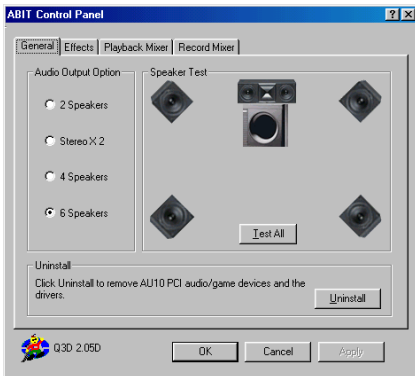

To test if all the speakers were properly installed, click on “Test All” button. Please watch carefully the movement of the music note shown on the screen to verify the correct placement of your speakers.

To uninstall this Audio Card driver, click on “Uninstall” button to disable the driver.

3-2. Windows 2000

Plug and Play Setup:

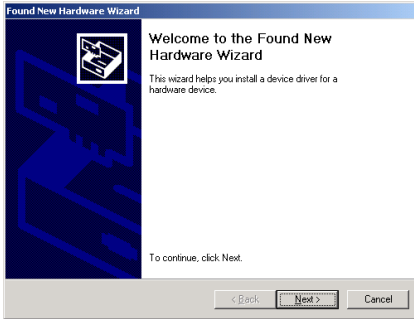

Start Windows.

When Windows detects your ABIT Home Theater AU10 audio card, the Found New Hardware Wizard dialog box appears. Click “Next>”.



Select “Search for a suitable driver for my device [recommended]”, and then click “Next>”.

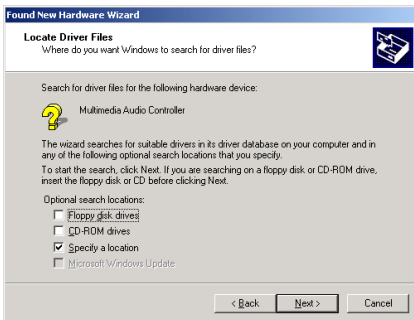

Select “Specify a location”, and then click “Next>”.



Insert the Installation CD into CD-ROM drive. Use the “**Browse...**” button to locate the driver, or type “**E:\WIN2000\ENU**” to specify the path. E is the CD-ROM drive. Click “**OK**” to continue.

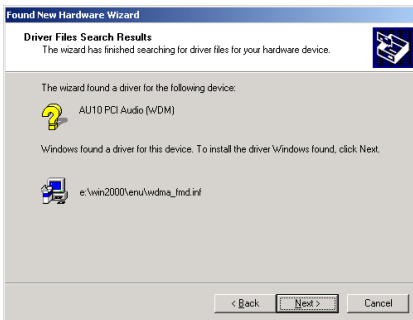

The wizard has found the driver for this device. Click “**Next>**” to continue.

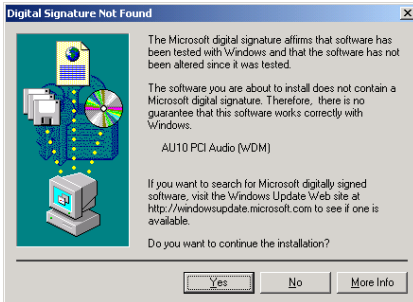

Click “**Yes**” to continue.



Windows has finished installing the software for this device. Click “**Finish**” to close the wizard.

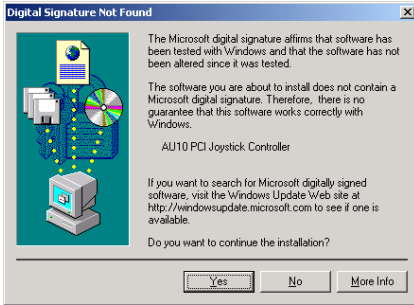

Now the system detects AU10 PCI Joystick Controller. Click “Yes” to end the installation.

Auto Setup:



Start Windows. Insert the Installation CD into CD-ROM drive, it should execute the installation program automatically. If not, execute the execution file at the main directory of this Installation Disk. After it has been executed, the setup screen appears. Click “AU10 Driver” to start installation.

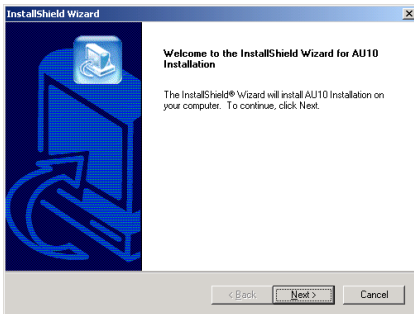

The welcome screen appears, click “Next>” to start installation.

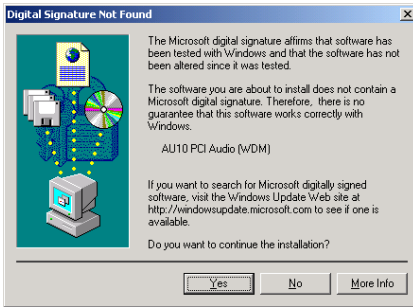

Click “Yes” to continue.

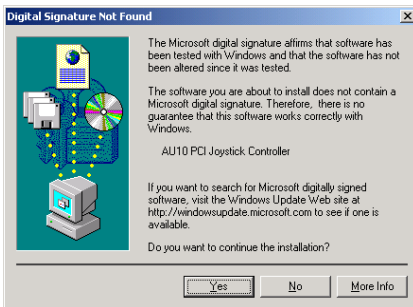

Click “Yes” to continue.

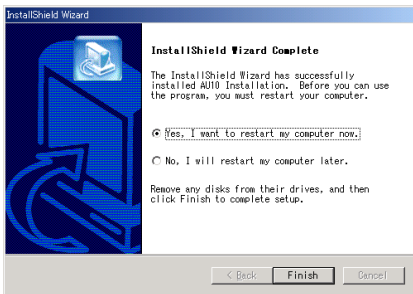

Choose “Yes, I want to restart my computer now”, and then click “Finish” to complete setup.

3-3. Windows XP

The procedures of driver installation on Windows XP are similar to those on Windows 2000. Please refer to the section of Windows 2000 for installing driver on Windows XP.

Chapter 4. Utility Setup

4-1. The WinDVD

The WinDVD is a simple-to-use DVD player combining all the features you would expect to find in a standard consumer DVD player, in addition to some very advanced functionality, such as full VCD 2.0 support, full precision video decode, a choice of user interfaces, and video display options. You can play DVD titles or Video CDs - WinDVD automatically determines the type of disc in the DVD drive and uses the correct playback method.

Install WinDVD:

Start Windows. Insert the Installation CD into CD-ROM drive, it should execute the installation program automatically. If not, double-click the execution file at the main directory of this Installation CD to enter the installation menu.



Click “**WinDVD**”.

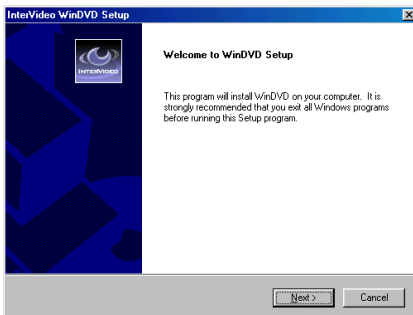

The welcome screen appears. Click “**Next>**” to start installation.

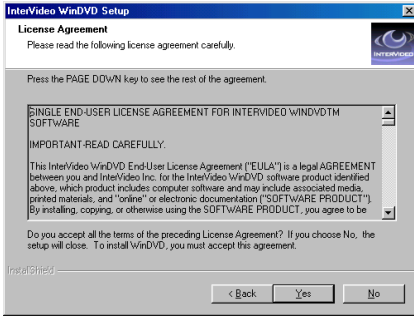

Read the license agreement. Click “**Yes**” to continue.

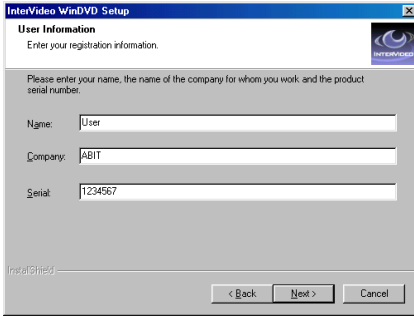

Enter your name, the name of the company for whom you work, and the product serial number. Click “**Next>**” to continue.

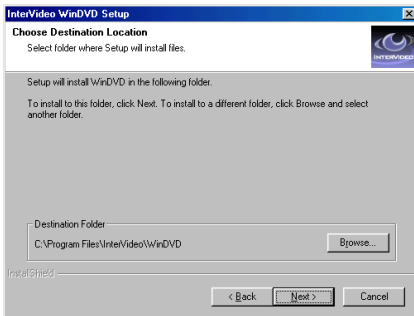

Setup will install WinDVD in the following folder. To install to this folder, click “**Next>**”. To install to a different folder, click “**Browse...**” and select another folder.

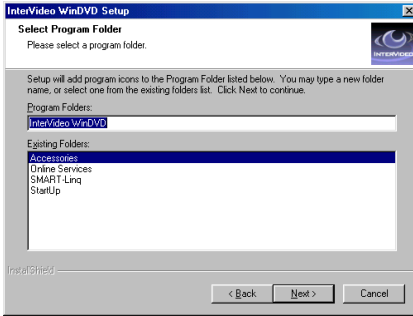

Type a new folder name, or select one from the existing folders list. Click “**Next>**” to continue.

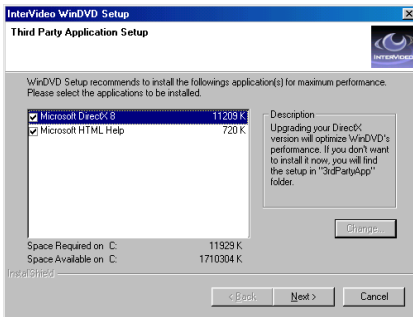

Select the application you want to install, and then click “**Next>**”.



When the installation has finished installing all the necessary procedures, it will prompt you to restart your computer. Click “**OK**” to complete the installation.

4-2. The WinRip

The WinRip application, a complete audio playback and recording environment for all currently available audio formats, including MP3, MP2, WAVE, MIDI, and Audio CD formats for ABIT's 5.1 channel playing device, enables you to swap and convert between these formats freely.

Install WinRip:

Start Windows. Insert the Installation CD into CD-ROM drive, it should execute the installation program automatically. If not, double-click the execution file at the main directory of this Installation CD to enter the installation menu.



Click “WinRip”.

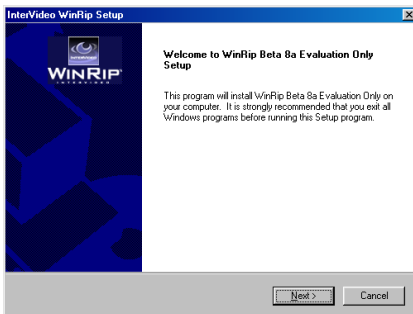

Click “Next>”.



Click “Yes>”.



Type your name, company name, and serial number of this software. Click “Next>” to go on.



Select the setup language you want. Click “Next>” to go on.



Choose the destination location you want by entering the “**Browse...**” button, or you may click “**Next>**” to go on.

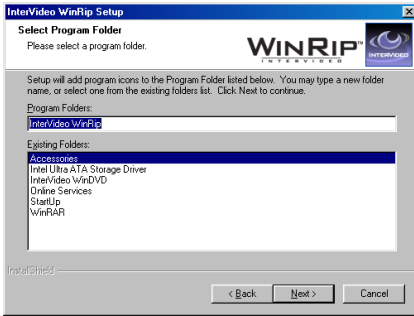

Type the new folder name you want, or click “**Next>**” to go on.

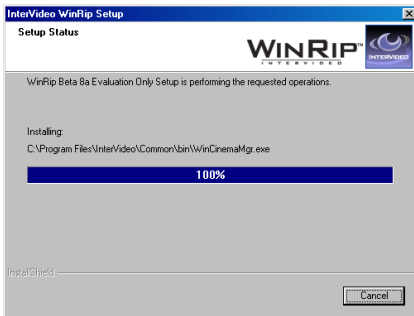

WinRip is now installing.



Click “**Start>**” to go on.



Type your registration information and click “**Next>**” to go on, or you may click “**Cancel**” to skip this step and finish the registration later.



Select the extensions names associated with WinRip, and click “**Next>**” to go on.

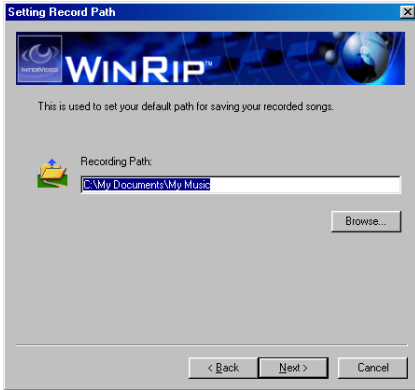

Type your recording path for recorded songs, or you may click “**N**ext>” to go on with the default path.



Check the recording type. There are 128 (default), 160, 192, 224, 256, and 320 kbps options to select. Click “**N**ext>” to go on.



Click “**F**inish” to end the installation.

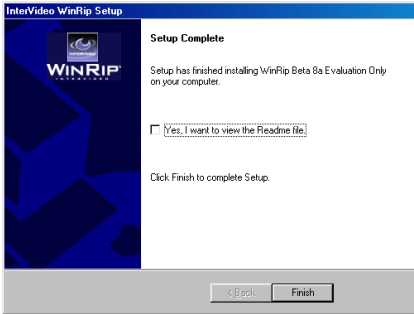

Windows has finished installing WinRip. Enable the check box if you want to view the Readme file, or click “**Finish**” to complete setup.

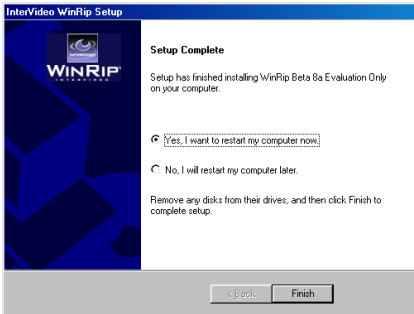

Check “**Yes, I want to restart my computer now**”, and click “**Finish**” to complete setup.

WinRip Configuration:

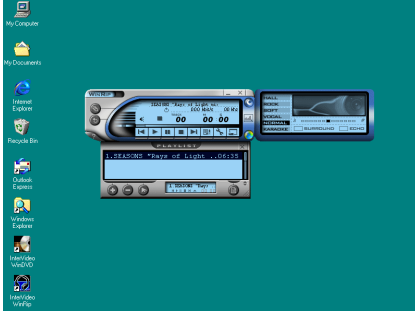

Double-click the WinRip icon on the desktop.

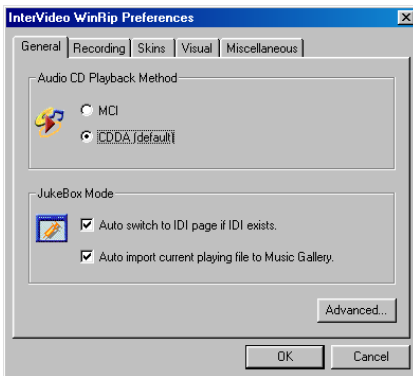

Click “Advanced...” button to go on.

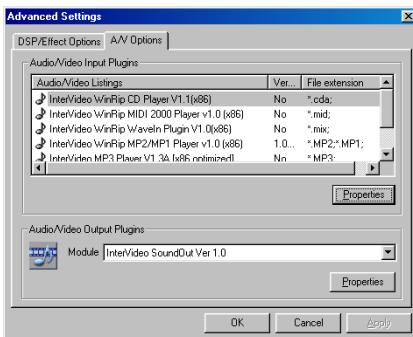

Select the A/V Options tab, and click the “**Properties**” button of Audio/Video Output Plugins to go on.

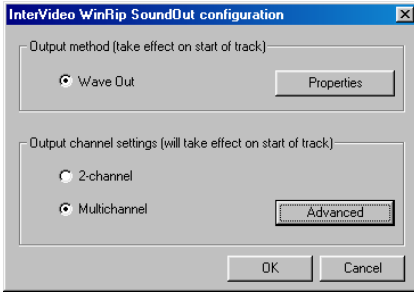

Choose “Multichannel” and click “Advance” button.

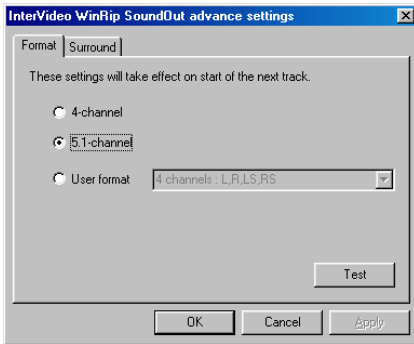

Choose 5.1-channel and click “OK” button.

Keep clicking “OK” button in the up-coming screens.

The output channel settings will take effect immediately on the start of next track.

4-3. YAMAHA SoftSynthesizer

The YAMAHA SoftSynthesizer is an application to control the audio quality of your ABIT Home Theater AU10 audio card.

Start Windows. Insert the Installation CD into CD-ROM drive, it should execute the installation program automatically. If not, double-click the execution file at the main directory of this Installation CD to enter the installation menu.



Click “YAMAHA S-YXG50” to start installing.

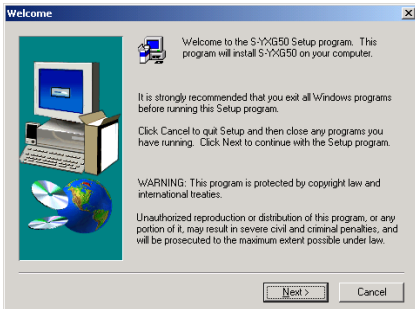

The welcome screen appears. Click “Next>” to start installation.

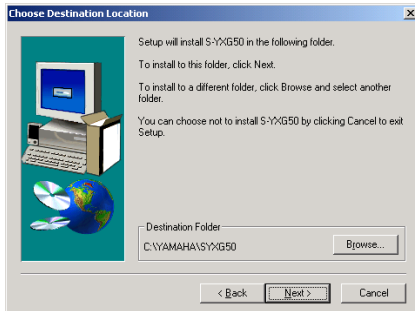

Setup will install S-YXG50 in the following folder. To install to this folder, click “**N**ext>”. To install to a different folder, click “**B**rowse...” and select another folder.

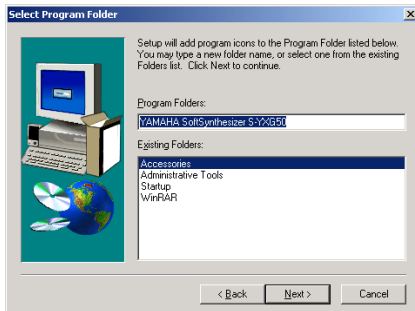

Type a new folder name, or select one from the existing folders list. Click “**N**ext>” to continue.

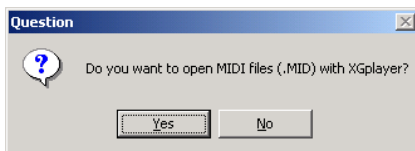

Click “**Y**es” if you want to open MIDI files (.MID) with XGplayer.

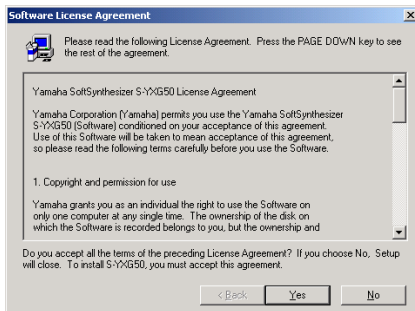

Read the following license agreement carefully. Click “**Y**es” to continue.

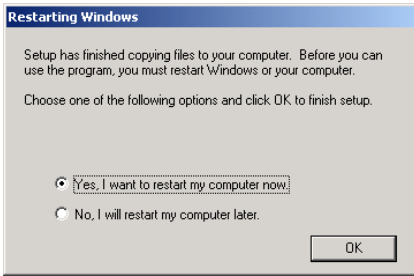

Choose “Yes, I want to restart my computer now”, and click “OK” to finish setup.



After computer restarted, double-click on the YAMAHA SoftSynthesizer icon in task bar to bring out its control panel.



Click on the adjustment tool to enter the “MIDI Output Port” selection screen.

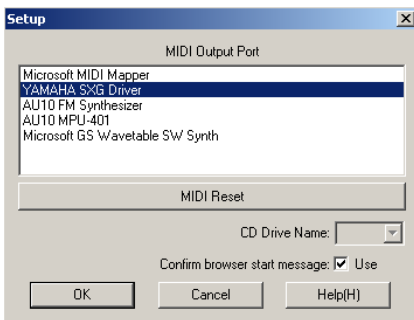

Choose your MIDI output port. Click “OK” to exit.

In order to acquire a normal operation of the 6-channel output, it is highly recommended to set the hardware acceleration to the fullest for a maximum usage of the CPU.

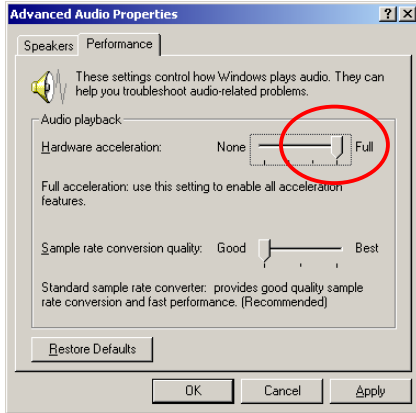

Click “Start” → “Control Panel” → “Sounds and Multimedia” → “Audio” → “Advanced” → “Performance”. Move the slider of “Hardware acceleration” to “Full” position.

4-4. The DirectX



For the best gaming capability in 3D hardware acceleration, please install the latest DirectX driver.

Start Windows. Insert the Installation CD into CD-ROM drive, it should execute the installation program automatically. If not, execute the execution file at the main directory of this Installation Disk. After it has been executed, the setup screen appears. Click **“DirectX”** to start the installation.

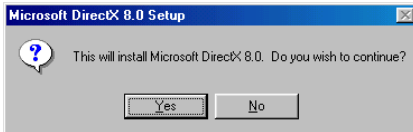

Click **“Yes”** to start installation.

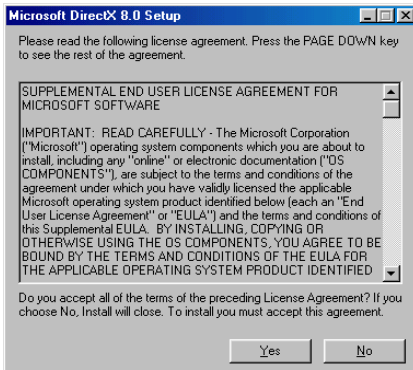

Read the following license agreement carefully. Click **“Yes”** to continue.

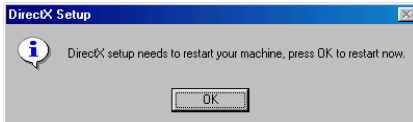

When the installation has finished installing all the necessary procedures, it will prompt you to restart your computer. Click **“OK”** to complete the installation.

NOTE: Some games written for older DirectX version may not work properly under DirectX 8.0. Please make sure your application support DirectX 8.0 before installation. Also note that the DirectX 8.0 cannot be uninstalled in normal way.

Appendix A. Product FAQ

The following tips for troubleshooting is to examine the evidence you have, gain as much information as you can, and eliminate possibilities one by one. In most cases, the source of the problem will soon become clear. For example, if this audio card works fine when you remove all the other add-on cards from your computer, but it stops working when you replace your fax-modem, there maybe a conflict between the audio card and the fax-modem (such as port address or IRQ). Often, problems are extremely simple: cable not plugged in or turned on, etc. Check the obvious first, not last.

Q1: What are the configuration problems?

Adding new hardware and software to your computer requires ensuring that there are no conflicts with your existing system. If you have difficulty with the installation procedure or are unable to make the card work, a conflict may be present. There are three major configuration settings to consider: I/O Port Address, Interrupt Request lines (IRQ), and Direct Memory Access channels (DMA).

Even though this audio card is a plug and play card, the presence of other legacy cards can still cause resource conflicts. To resolve such conflicts, it is important to know the settings of other cards (it is best to remove other audio cards) and peripherals currently in your system, including the mouse, fax-modem, video accelerators, etc. Many peripherals come with setup software similar to this audio card that lets you see and change the current configuration. There are also utility programs that investigate and report on the configuration of your system and its peripherals. In either event, make a record of the settings used by all the peripherals in your system for reference when installing new hardware and software or trouble shooting problems.

Generally, you will only have a DMA conflict if your system contains another audio card or an external CD/DVD-ROM drive.

Q2: What are DMA Channels and PCI?

Under Windows 9x, this audio card is capable of full duplex. This means that the card can playback one .WAV file while recording another. With the PCI bus full duplex is possible without any DMA channels.

There is no microphone support in the MS-DOS Mode and therefore only a single DMA is required for legacy emulation.

Q3: What should I do if I have problems with playing games?

Make sure that you have the game set up in a music option that this audio card supports. If the game takes advantage of DirectX or DirectSound be sure that you have the latest DirectX drivers from Microsoft. If you are having a problem with external joystick or gamepad, make sure that the Joystick is enabled and the Windows 9x Gameport Joystick drivers are loaded and working properly in the Device Manager.

In order to use two joysticks, you will need to use a SoundBlaster-compatible Y-connector (such as Radio Shack part # 26-380), or use an industry-standard MIDI Joystick kit. This will make allowances for the proper direct connections for dual joysticks.

Q4: Can I install two audio cards?

Having another audio card in your system in addition to this audio card will greatly increase the chances of having system conflicts. We highly recommend that any other sound devices and their associated Windows drivers be removed before installing this audio card.

Q5: Why are some of the Windows Multimedia Components (i.e. Media Player) missing?

If you install this audio card after Windows 9x is installed, Windows will not install the sound utilities that you would expect to find. Features such as the Audio CODEC, the Media Player, and the Microsoft Mixer may not be present. This may cause your audio card to not function properly, even when our drivers are installed. If this is the case, these applications must be installed onto the system from the Windows 9x installation media.

Q6: What happened if my AU10 audio card and driver are both properly installed, yet, there is still no sound?

If this audio card and drivers are properly installed with no conflicts, yet there is no sound, the problem may be with your audio connections. Here are some suggestions:

Try playing both a “.WAV” file and a .MID file to ascertain that there is no sound at all coming from the speakers. If you hear one and not the other, the problem is internal and has nothing to do with your audio system.

Make sure your monitoring system is properly set up. Try connecting a sound source other than this audio card, such as an audio CD player, and establishing whether or not you can hear it.

Make sure the audio card is properly connected to the monitoring system (a 1/8-inch mini-phone cable should be running from this audio card “FRONT” connector to a line input on the monitoring system). To eliminate the possibility

of a bad cable, try plugging a pair of high-impedance headphones to this audio card "FRONT" jack and see if you hear any sound.

Q7: How do I change volume and balance levels in Windows 9x?

Enter the volume control menu by double-clicking the volume control icon located at the right side of the taskbar.

Q8: My microphone records at very low levels, with distortion, or not at all?

For ease of installation, we recommend that you use a dynamic microphone. These require the least amount of setup. Do the following steps to be sure that your software is set up correctly for MIC input:

Double-click the volume control icon located at the right side of the taskbar.

Under the Recording panel of Mixer make sure MIC is checked.

Make sure the MIC slider is all the way up, the mute box is not checked and the Boost box is checked.

If you experience distortion with a dynamic microphone adjust the volume levels of the Microphone and Master audio devices.

Q9: Why doesn't my CD audio work?

First, be sure that your CD volume is turned up to the maximum in the Mixer. If you still aren't getting music, you will need to verify that the internal patch cable is connected between your CD ROM drive and the audio card's CD Input. This is typically a small connector with four wires coming out of it.

Another tip is to obtain a 1/8" stereo patch cord and connect one end to the "headphone out" on the front of the CD/DVD-ROM drive, and the other end to the Line Input on the back of the audio card. Make sure the headphone volume dial on the CD/DVD-ROM drive is at maximum, and try playing a CD. You should hear the music playing. If your internal patch cable is missing or defective, contact your CD/DVD-ROM manufacturer for information on how to obtain another cable.

Q10: What to do if audio card is not found or IRQ is not assigned to this audio card?

Change slot: insert this audio card into another PCI slot. (Do so by first shutting down the computer. Remove the audio card and insert it into another PCI slot.) If the problem persists: if you are a new user, uninstall the driver and re-install it from the beginning. (For uninstalling instructions, see "UN-installing the AU10 driver" section below.)

Adjust BIOS settings: get into BIOS (usually, hit <F1>, or <F10> after Reboot), get into the Section with title "PCI/PnP", make sure it reserves enough

IRQ for PCI devices. If there is a “Reset Configuration” option, change it to “Yes/Enable”, if there is a “PnP OS” option, change it to “NO”.

Q11: The SB Games are not working properly...

DOS games run best with PCI IRQ 5/7/9 assigned to audio card. This can be verified through “Control Panel” → “Device Manager” → “Sound, Video, and Games” → “AU10 PCI Audio”.

For the best results of DOS game play and to reduce potential problem(s) of the additional layer of routing, change BIOS setting to reserve PCI IRQ 5/7/9/10 for PCI Devices.

Some old DOS games may not work in a Windows DOS Box. If this is the case, shut down the system to MS-DOS mode and play the game in Real DOS mode.

Q12: How to adjust SB IRQ/IO/DMA for some DOS Games?

Some DOS games may need certain fixed resource (IRQ and DMA). This adjustment can be achieved by selecting the following path: “Control Panel” (from the Windows Main Menu, click the Start button located at the lower left hand corner and select Control Panel from Settings) → “System” → “Device Manager” → “Sound, Video, and Games” → “Legacy Audio Device”.

Click “Resource” Tab to change the Legacy Audio Device I/O, IRQ, and DMA.

Q13: I have bought the audio card with Yamaha software Wavetable synthesizer in the package. But I can not install Yamaha Wavetable synthesizer in my computer.

Please install the Win98 driver first before install Yamaha Software Wavetable Synthesizer. This audio card driver has to be installed first in order to install Yamaha Wavetable driver.

Q14: Does this audio card support Linux OS?

This audio card supports Windows 98, Windows NT 4.0 and DOS. Linux is not supported by AU10 in the current driver set.

Q15: What are the 2-speaker, 4-speaker and 6-speaker Audio Output Options used that can be found in Control Panel?

These buttons are designed for the end users to configure how many speakers have been connected to your audio card. For example, If your audio card is a 4-channel audio card, then you can choose to connect 2 speakers or 4 speakers to your system. The default will be set to 4 speakers. However, if you choose to connect to 2 speakers, this audio card driver will not allow you to select Quad mode in your QSound Control Panel (for the driver bundled with Q3D only) or in some of the software DVD player setup menu.

Q16: Why are two interrupts allocated for my AU10 audio card?

The PCI audio uses one PCI interrupt for operation. Additional IRQ is used for ISA legacy support, an additional to the PCI IRQ.

One PCI IRQ is needed for the audio to function under a PnP operating systems such as Windows 9x. One additional ISA IRQ is dedicated for legacy audio support. Legacy audio support is used for DOS based applications and games that are SoundBlaster compatible. Most DOS based applications and games only use SoundBlaster compatible legacy audio requiring the use of a ISA IRQ. By disabling the ISA legacy audio support in the operating system the dedicated ISA IRQ is freed, thus using only one PCI IRQ. DOS Applications and games that require SoundBlaster Audio support will have no audio output if ISA legacy audio is disabled.

Another way to save one IRQ is to make the BIOS assign IRQ5 or IRQ7 or IRQ9 to this audio card. In this way, ISA legacy audio can also be supported via this audio card. Please refer to BIOS user manual to see the details of how to allocate the IRQ to PCI slots.

Q17: How to Get Technical Support

If you encounter any problems and need help from our technical staff, please take the time to fill out the Technical Support Form and send it to your dealer or our technical support mailbox. The mailbox address is: technical@abit.com.tw. We will try to solve your problem as soon as possible. You must provide specific information on your equipment. Also please describe in detail the problems you encountered. It's helpful and enables our technicians to analyze your problems more quickly.

Information on items marked with an asterisk "*" on the Technical Support Form are required.

📖 Technical Support Form

🏢 **Company Name:**

☎ **Phone Number:**

👤 **Contact Person:**

📠 **Fax Number:**

✉ **E-mail Address:**

Audio Card Product Name	*	Audio Card Software and Driver Version	*
Motherboard Manufacturer, Model Name and Chipset type	*		*
Operating System Type	*		*
Hardware name	Type	Specifications	
CPU Type and Speed	*		
HDD	IDE1 IDE2		
CD-ROM Drive	IDE1 IDE2		
System Memory Size (SDRAM)	*		
	*		
Add-On Card			

Problem Description:



Appendix B. How to Get Technical Support

(From our website) <http://www.abit.com.tw>

(In North America) <http://www.abit-usa.com>

(In Europe) <http://www.abit.nl>

Thank you for choosing ABIT products. ABIT sells all our products through distributors, resellers and system integrators; we have no direct sales to end-users. Before sending email for tech support please check with your resellers or integrators if you need any services, they are the ones who sold you your system and they should know best as to what can be done, how they serve you is a good reference for future purchases.

We appreciate every customer and would like to provide the best service to you. Providing fast service to our customers is our top priority. However we receive many phone calls and a huge amount of email from all over the world. At the present time it is impossible for us to respond to every single inquiry. Therefore it is quite possible that if you send an email to us that you may not receive a response.

We have done many compatibility tests and reliability tests to make sure our products have the best quality and compatibility. In case you need service or technical support, please understand the constraint we have and **always check with the reseller who sold the product to you first.**

To expedite service, we recommend that you follow the procedures outlined below before contacting us. With your help, we can meet our commitment to provide the best service to the **greatest number of ABIT customers:**

1. **Check the Manual.** It sounds simple but we have taken a lot of care in making a well-written and thorough manual. It is full of information that doesn't only pertain to motherboards. The CD/DVD-ROM included with your board will have the manual as well as drivers. If you don't have either one go to our Program Download Area of the website or FTP server.
2. **Download latest BIOS, software or drivers.** Please go to our Program Download area on our website to check to see if you have the latest driver. They are developed over periods of time to fix bugs or incompatibilities. **Also please make sure you have the latest drivers from your peripheral cards makers!**
3. **Check the ABIT Technical Terms Guide and FAQ on our website.** We are trying to expand and make the FAQs more helpful and information rich. Let us know if you have any suggestions. For hot topics check out our HOT FAQ!

4. **Internet Newsgroups.** They are a great source of information and many people there can offer help. ABIT's Internet News group, alt.comp.periphs.mainboard.abit, is an ideal forum for the public to exchange information and discuss experiences they have had with ABIT products. Many times you will see that your question has already been asked before. This is a public Internet news group and it is reserved for free discussions. Here is a list of some of the more popular ones:

alt.comp.periphs.mainboard.abit
comp.sys.ibm.pc.hardware.chips
alt.comp.hardware.overclocking
alt.comp.hardware.homebuilt
alt.comp.hardware.pc-homebuilt

4. **Ask your reseller.** Your ABIT authorized distributor should be able to provide the fastest solution to your technical problem. We sell our products through distributors who sell to resellers and stores. Your reseller should be very familiar with your system configuration and should be able to solve your problem much more efficiently than we could. After all, your reseller regards you as an important customer who may purchase more products and who can urge your friends to buy from him or her as well. They integrated and sold the system to you. They should know best what your system configuration is and your problem. They should have reasonable return or refund policies. How they serve you is also a good reference for your next purchase.
5. **Contacting ABIT.** If you feel that you need to contact ABIT directly you can send email to the ABIT technical support department. First, please contact the support team for the branch office closest to you. They will be more familiar with local conditions and problems and will have better insight as to which resellers offer what products and services. Due to the huge number of emails coming in every day and other reasons, such as the time required for problem reproduction, we will not be able to reply to every email. Please understand that we are selling through distribution channels and don't have the resources to serve every end-user. However, we will try to do our best to help every customer. Please also remember that for many of our technical support team English is a second language, you will have a better chance of getting a helpful answer if your question can be understood in the first place. Be sure to use very, simple, concise language that clearly states the problem, avoid rambling or flowery language and always list your system components. Here is the contact information for our branch offices:

In North America and South America please contact:

ABIT Computer (USA) Corporation

46808 Lakeview Blvd.

Fremont, California 94538, U.S.A.

sales@abit-usa.com

technical@abit-usa.com

Tel: 1-510-623-0500

Fax: 1-510-623-1092

In the UK and Ireland:

ABIT Computer Corporation Ltd.

Unit 3, 24-26 Boulton Road

Stevenage, Herts SG1 4QX, UK

abituksales@compuserve.com

abituktech@compuserve.com

Tel: 44-1438-228888

Fax: 44-1438-226333

In Germany and Benelux (Belgium, Netherlands, Luxembourg) countries:

AMOR Computer B.V. (ABIT's European Office)

Van Coehoornstraat 7,

5916 PH Venlo, The Netherlands

sales@abit.nl

technical@abit.nl

Tel: 31-77-3204428

Fax: 31-77-3204420

All other territories not covered above please contact:

Taiwan Head Office

When contacting our headquarters please note we are located in Taiwan and we are 8+ GMT time. In addition, we have holidays that may be different from those in your country.

ABIT Computer Corporation

No. 323, YangGuang St.,

Neihu, Taipei, 114, Taiwan

sales@abit.com.tw

market@abit.com.tw

technical@abit.com.tw

Tel: 886-2-8751-8888

Fax: 886-2-8751-3381

6. **RMA Service.** If your system has been working but it just stopped, but you have not installed any new software or hardware recently, it is likely that you have a defective component. Please contact the reseller from whom you bought the product. You should be able to get RMA service there.
7. **Reporting Compatibility Problems to ABIT.** Because of tremendous number of email messages we receive every day, we are forced to give greater weight to certain types of messages than to others. For this reason, any compatibility problem that is reported to us, giving detailed system configuration information and error symptoms will receive the highest priority. For the other questions, we regret that we may not be able to reply directly. But your questions may be posted to the Internet news group in order that a larger number of users can have the benefit of the information. Please check the news group from time to time.

Thank you, ABIT Computer Corporation

<http://www.abit.com.tw>