



Your Reliable Partner

# WI-2Pa

---

## *Dual Socket 604 Workstation Board User's Manual*

4200-0349-22

Rev. 1.00

---

---

### **Copyright and Warranty Notice**

The information in this document is subject to change without notice and does not represent a commitment on part of the vendor, who assumes no liability or responsibility for any errors that may appear in this manual.

No warranty or representation, either expressed or implied, is made with respect to the quality, accuracy or fitness for any particular part of this document. In no event shall the manufacturer be liable for direct, indirect, special, incidental or consequential damages arising from any defect or error in this manual or product.

Product names appearing in this manual are for identification purpose only and trademarks and product names or brand names appearing in this document are property of their respective owners.

This document contains materials protected under International Copyright Laws. All rights reserved. No part of this manual may be reproduced, transmitted or transcribed without the expressed written permission of the manufacturer and authors of this manual.

---

---

# Contents

---

<b>Chapter 1. Introduction .....</b>	<b>1-1</b>
1.1. Features & Specifications.....	1-1
1.2. Package Checklist.....	1-3
1.3. Layout Diagram.....	1-4
<b>Chapter 2. Hardware Setup.....</b>	<b>2-1</b>
2.1. Precautions .....	2-1
2.2. Installing the Workstation Board .....	2-2
2.3. Install Xeon CPU and Heatsink .....	2-3
2.4. System Memory .....	2-4
2.4.1. Memory Configuration Table.....	2-4
2.4.2. Installing and Removing Memory Modules.....	2-4
2.5. Connectors, Headers, and Switches .....	2-6
2.5.1. ATXPWR1, ATX12V1: EPS12V Power Connectors .....	2-6
2.5.2. FAN1~6: FAN Connectors.....	2-7
2.5.3. CCMOS1: CMOS Memory Clearing Header.....	2-8
2.5.4. FPIO1: Front Panel Switches and Indicators Header .....	2-9
2.5.5. FDC1, IDE0/IDE1 Connectors:.....	2-10
2.5.6. PCI Slots:.....	2-11
2.5.7. 6CHAUD1: 5.1-Channel Audio Interface Header .	2-12
2.5.8. USB1/USB3: Additional USB Ports Headers .....	2-13
2.5.9. CD1, AUX1: Internal Audio Connector.....	2-14
2.5.10. IR1: Infrared Device Header .....	2-15
2.5.11. Back Panel Connectors:.....	2-16
<b>Chapter 3. BIOS Setup.....</b>	<b>3-1</b>
3.1. Main Menu .....	3-2
3.2. Advanced Menu .....	3-6

---

---

3.2.1.	Advanced BIOS Features .....	3-6
3.2.2.	Advanced Chipset Features .....	3-9
3.2.3.	Integrated Peripherals .....	3-11
3.2.4.	Power Management Setup .....	3-16
3.2.5.	PnP/PCI Configurations.....	3-20
3.3.	Security Menu .....	3-22
3.4.	PC Health Menu .....	3-23
3.5.	Clk/Misc. Menu.....	3-25
3.6.	Exit Menu .....	3-26
<b>Chapter 4.</b>	<b>Driver Installation .....</b>	<b>4-1</b>
<b>Appendix A.</b>	<b>Trouble Shooting .....</b>	<b>A-1</b>
<b>Appendix B.</b>	<b>How to Get Technical Support .....</b>	<b>B-1</b>

---

## Chapter 1. Introduction

---

### 1.1. Features & Specifications

#### CPU

- Supports Dual Intel® Xeon processor (603-pin or 604-pin)

#### Chipset

- Intel® E7505 chipset supports 400MHz/533MHz Front Side Bus
- Intel® 82801DB (ICH4) supports PCI 2.2, Ultra DMA100 IDE protocol
- Intel® 82870P2 (P64H2) supports PCI-X 66/100MHz

#### Memory

- Six 184-pin DIMM sockets support DDR200/DDR266 RAM module
- Supports up to 12GB (Registered ECC)
- Supports up to 8GB (Unbuffered, Non ECC)

#### LAN

- Onboard Intel 82545EM (Kenai-64) Gigabit Ethernet Controller
- 10/100/1000 Mb Ethernet

#### Graphics

- AGP8x/4x AGP Pro

#### System BIOS

- AWARD Plug and Play BIOS supports APM, DMI, and ACPI
- Write-Protect Anti-Virus function by AWARD BIOS
- 4M-bit Flash ROM

#### I/O Slot

- 2 33MHz/32bit PCI slots
- 1 PCI-X 100MHz/64bit slot
- 2 PCI 66MHz/64bit slots
- 1 AGP Pro slot

#### Multi I/O Functions

- 1 floppy port
- 2 channels of bus master IDE ports supporting up to four Ultra DMA100 devices

- 1 parallel port, 2 serial ports and 1 game port
- PS/2 keyboard and PS/2 mouse connectors
- Support 6 USB ports
- Support AC97, 5.1Channel (Option)
- Support S/PDIF (Option)

**Miscellaneous**

- 24-pin and 8-pin EPS 12V power connectors
- Extend ATX form factor (12" x 13")

\* **Specifications and information contained herein are subject to change without notice.**

## **1.2. Package Checklist**

- (1) WI-2Pa Workstation board
- (1) Brief Installation Guide
- (1) Driver & Utilities CD
- (1) Ribbon cable for (1) 3.5" floppy disk drive
- (2) Ribbon cables for master and slave IDE drives
- (1) CPU Retention Mechanism
- (2) Retention Clips for 603-pin CPU
- (2) Retention Clips for 604-pin CPU
- (1) I/O Shield
- (1) 2-port USB 2.0 cable

### 1.3. Layout Diagram

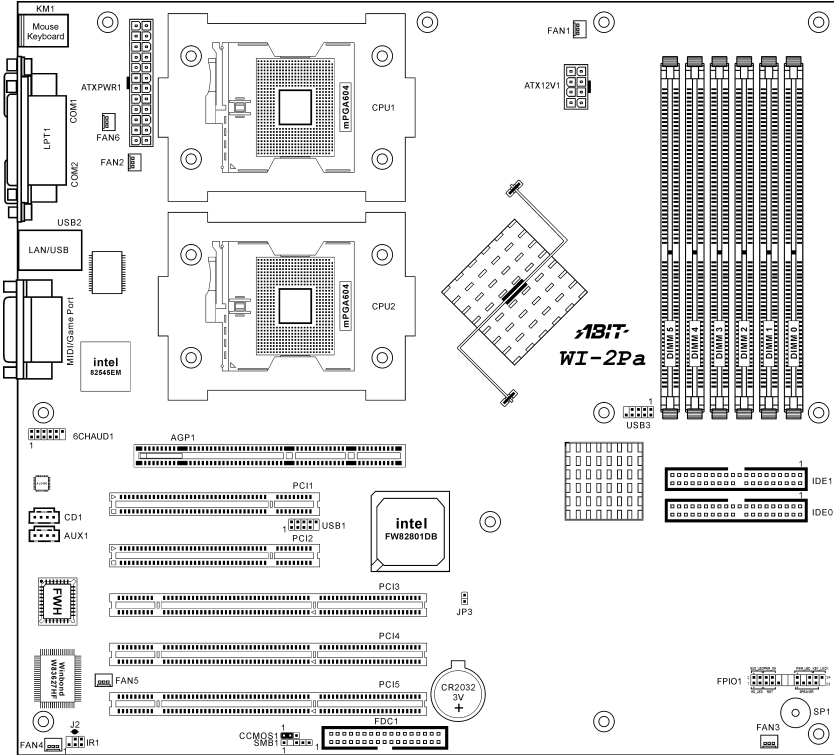



---

<b>Jumpers</b>	<b>Description</b>	<b>Default Setting</b>
CCMOS1	CMOS Clear	Pins 1-2 (Normal) Closed

---

<b>Connectors</b>	<b>Description</b>
6CHAUD1	Optional ABIT CA-20 Interface Connector
AGP1	Slot for AGP8x/4x AGP Pro Display Card
ATX12V1	8-pin EPS12V Power Connector
ATXPWR1	24-pin EPS12V Power Connector
CD1/AUX1	Internal Audio Sources Connectors
DIMM 0~5	DDR DIMM Slots
FAN1	CPU1 Fan Connector (Speed monitoring support)
FAN2	CPU2 Fan Connector (Speed monitoring support)
FAN3	System Fan Connector (Speed monitoring support)
FAN4/5/6	System Fan Connector (No speed monitoring support in BIOS menu)
FDC1	Floppy Disk Drive Connector
FPIO1	Front Panel Switches & Indicators Headers
IDE0/IDE1	Hard Disk Drive Connectors
IR1	Optional Infrared Devices Connector
JP3	Chassis Intrusion Header
PCI1/2	PCI 33MHz/32bit
PCI3	PCI-X 100MHz/64bit
PCI4/PCI5	PCI 66MHz/64bit
SMB1	System Management Bus (SMBus) Header
USB1/USB3	Additional USB Ports Connectors

---



## **Chapter 2. Hardware Setup**

---

### **2.1. Precautions**

Please pay attention to the following precautions before setting up any hardware.

1. Always switch off the power supply and unplug the power cord from the wall outlet before installing the board or changing any settings.
2. Ground yourself properly by wearing a static safety wrist strap before removing the board from the antistatic bag.
3. Hold the board by its edges. Avoid touching any component on it.
4. Avoid touching module contacts and IC chips
5. Place the board on a grounded antistatic surface or on the antistatic bag that came with the board.

## 2.2. Installing the Workstation Board

Before installing the workstation board, exam your chassis to ensure this workstation board fits into it. Your chassis should support Extend ATX form factor.

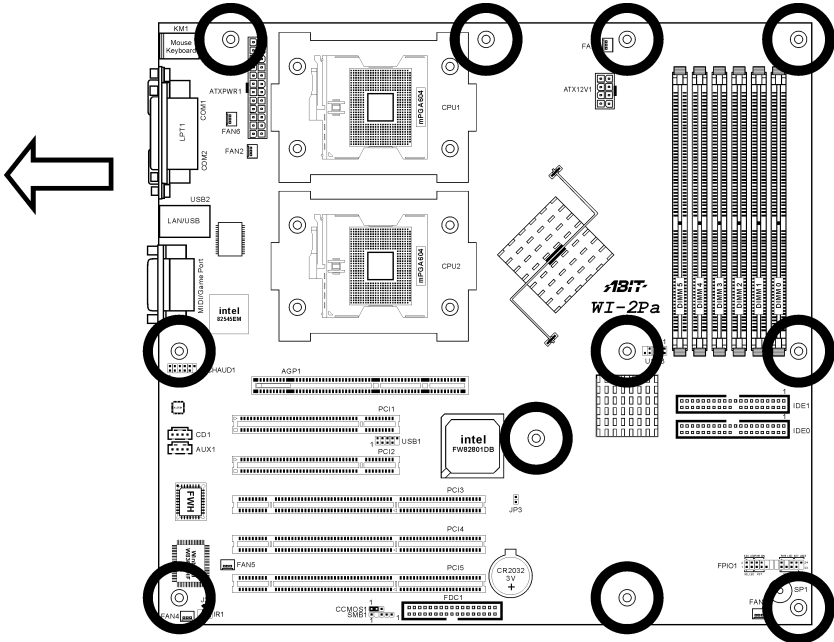

1. Face the side of the I/O ports toward the rear part of the chassis.
2. Locate the screw holes on the workstation board and the chassis base.
3. Place all the studs or spacers needed on the chassis base and have them tightened.
4. Line up all the screw holes on the board with those studs or spacers on the chassis.
5. Tightens all the screw holes.

**ATTENTION:** To prevent shorting the PCB circuit, please REMOVE the metal studs or spacers if they are already secured on the chassis base and are without mounting-holes on the workstation board to align with.

### 2.3. Install Xeon CPU and Heatsink

This workstation board provides you two Socket-604 sockets to install Intel Xeon CPU. The CPU you bought should have a kit of heatsink and cooling fan bundled together. If that's not the case, buy one specially designed for Xeon Socket 604 CPU. Please refer to the diagram shown below to install CPU and heatsink.

**NOTE:** This workstation board also supports the Xeon CPU of 603-pin package.

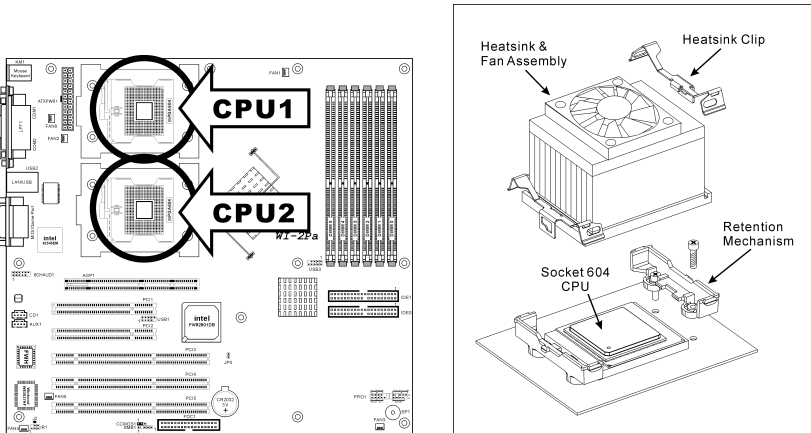

**NOTE:** The diagram shown here is for reference only. Your retention mechanism may not be exactly the same as this type. Please follow the installation instruction of the heatsink you bought.

## 2.4. System Memory

This workstation board provides six 184-pin Double Data Rate (DDR) Dual Inline Memory Module (DIMM) slots for Registered ECC DIMM modules with memory expansion size up to 12GB.

### 2.4.1. Memory Configuration Table

DIMM	Registered ECC DIMM Module	Total Memory
0	128MB, 256MB, 512MB, 1GB, 2GB	128MB ~ 2GB
1	128MB, 256MB, 512MB, 1GB, 2GB	128MB ~ 2GB
2	128MB, 256MB, 512MB, 1GB, 2GB	128MB ~ 2GB
3	128MB, 256MB, 512MB, 1GB, 2GB	128MB ~ 2GB
4	128MB, 256MB, 512MB, 1GB, 2GB	128MB ~ 2GB
5	128MB, 256MB, 512MB, 1GB, 2GB	128MB ~ 2GB
<b>Total System Memory</b>		256MB ~ 12GB

### 2.4.2. Installing and Removing Memory Modules

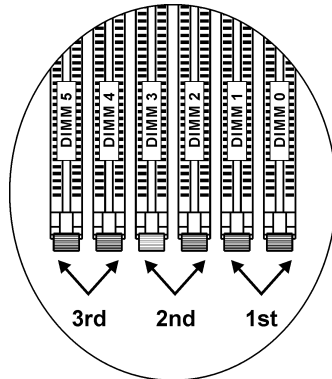
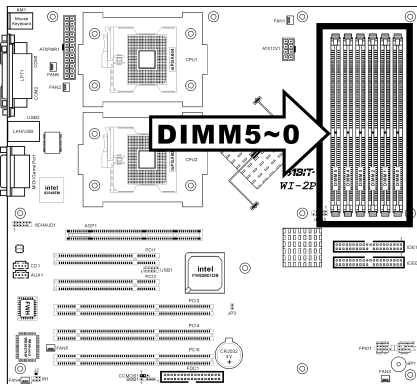

**ATTENTION:** Populate the DDR DIMMs **in-order** and **in-pair** (of the same type and size) by starting from *DIMM0~DIMM1*, *DIMM2~DIMM3*, to *DIMM4~DIMM5*. The System may hang or appear unstable if the DIMM ordering is not followed.

Power off the computer and unplug the AC power cord before installing or removing memory modules.

1. Locate the DIMM slot on the workstation board.
2. Hold two edges of the DIMM module carefully, keep away of touching its connectors.
3. Align the notch key on the module with the rib on the slot.
4. Firmly press the module into the slots until the ejector tabs at both sides of the slot automatically snaps into the mounting notch. Do not force the DIMM module in with extra force as the DIMM module only fit in one direction.
5. To remove the DIMM modules, push the two ejector tabs on the slot outward simultaneously, and then pull out the DIMM module.

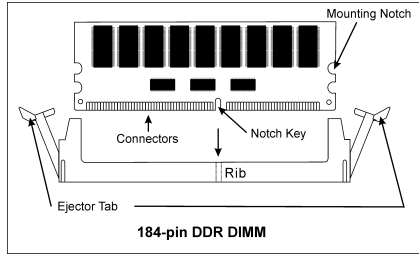

**ATTENTION:** As the static electricity can damage the electronic components of the computer or optional modules, make sure you are discharged of static electricity by touching a grounded metal object briefly before starting these procedures.





### 2.5.2. FAN1~6: FAN Connectors

- FAN1: CPU1 Fan
- FAN2: CPU2 Fan
- FAN3: System Fan
- FAN4~FAN6: System Fan (No speed monitoring support in BIOS menu)

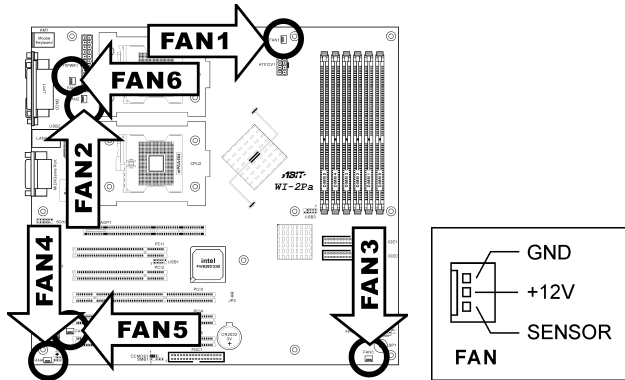

### 2.5.3. CCMOS1: CMOS Memory Clearing Header

This header uses a jumper cap to clear the CMOS memory. Short pin 2 and pin 3 only when you want to clear the CMOS memory. The default setting is pin 1 and pin 2 shorted for normal operation.

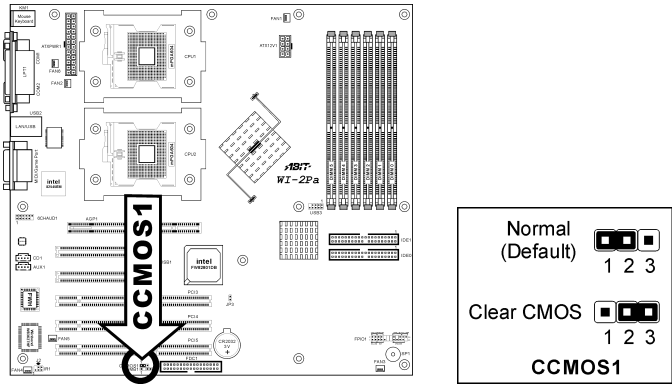

**ATTENTION:** Turn the system power off first (including the +5V standby power) before clearing the CMOS memory. Failing to do so may cause your system to work abnormally or malfunction.

### 2.5.4. FPIO1: Front Panel Switches and Indicators Header

This header is used for connecting switches and LED indicators on the chassis front panel.

Watch the power LED pin position and orientation. The mark “+” align to the pin in the figure below stands for positive polarity for the LED connection.

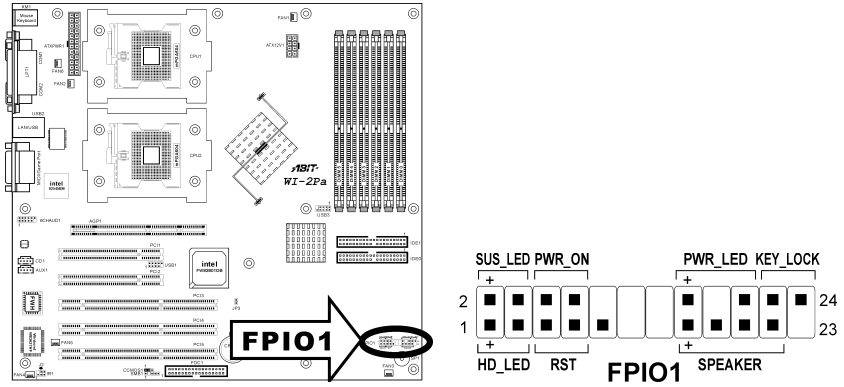

- **HD\_LED:** Connects to the HDD LED cable of chassis front panel.
- **RST:** Connects to the Reset Switch cable of chassis front panel.
- **SPEAKER:** Connects to the System Speaker cable of chassis.
- **SUS\_LED:** Connects to the Suspend LED cable (if there is one) of chassis front panel.
- **PWR\_ON:** Connects to the Power Switch cable of chassis front panel.
- **PWR\_LED:** Connects to the Power LED cable of chassis front panel.
- **KEY\_LOCK:** Connects to the Keylock cable (if there is one) of chassis front panel.

**2.5.5. FDC1, IDE0/IDE1 Connectors:**

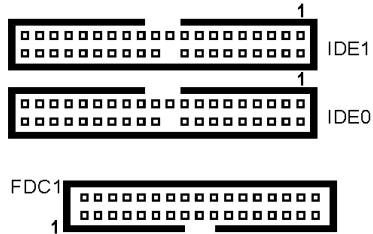
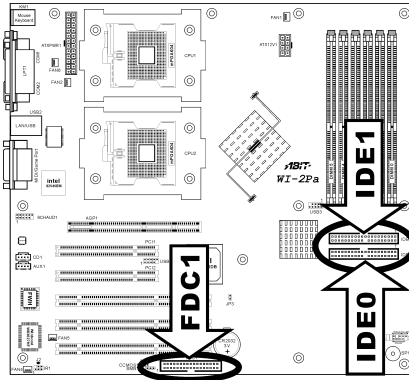

The FDC1 connector connects up to two floppy drives with a 34-wire, 2-connector floppy cable. Connect the single end at the longer length of ribbon cable to the FDC1 on the board, the two connectors on the other end to the floppy disk drives connector. Generally you need only one floppy disk drive in your system.

**NOTE:** The red line on the ribbon cable must be aligned with pin-1 on both the FDC1 port and the floppy connector.

Each of the IDE port connects up to two IDE drives at Ultra ATA/100 mode by one 40-pin, 80-conductor, and 3-connector Ultra ATA/66 ribbon cables.

Connect the single end (blue connector) at the longer length of ribbon cable to the IDE port of this board, the other two ends (gray and black connector) at the shorter length of the ribbon cable to the connectors of your hard drives.

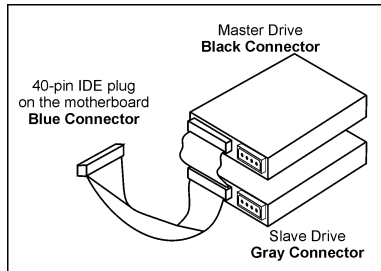

**NOTE:** Make sure to configure the “Master” and “Slave” relation before connecting two drives by one single ribbon cable. The red line on the ribbon cable must be aligned with pin-1 on both the IDE port and the hard-drive connector.



### 2.5.7. 6CHAUD1: 5.1-Channel Audio Interface Header

This header provides 5.1-channel audio output through optional ABIT CA-20 interface.

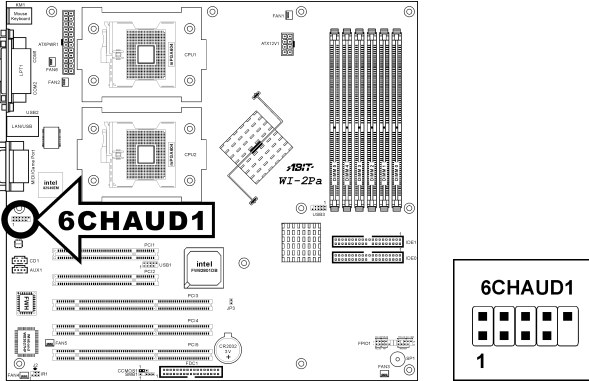

To enable the audio function on optional CA-20 interface, use the extension cable packed with CA-20 to connect both the 6CHAUD1 headers on CA-20 and this board.

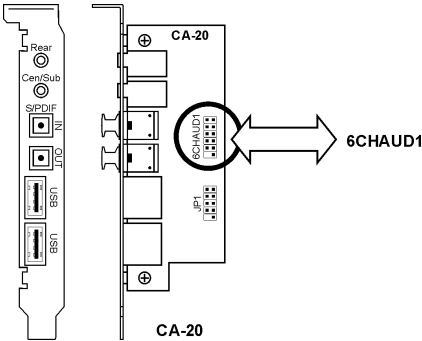

### 2.5.8. USB1/USB3: Additional USB Ports Headers

These headers each provide two additional USB ports connection.

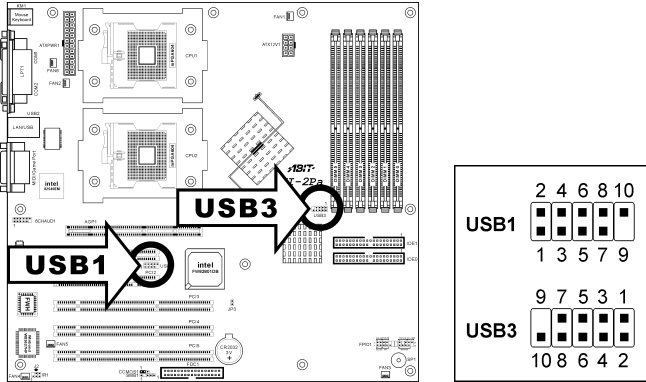

Pin	Pin Assignment	Pin	Pin Assignment
1	VCC	2	VCC
3	Data0 -	4	Data1 -
5	Data0 +	6	Data1 +
7	Ground	8	Ground
9	NC	10	NC

To enable the USB function on optional CA-20 interface, use the extension cable packed with CA-20 to connect the JP1 header on CA-20 and the USB1 header on this board.

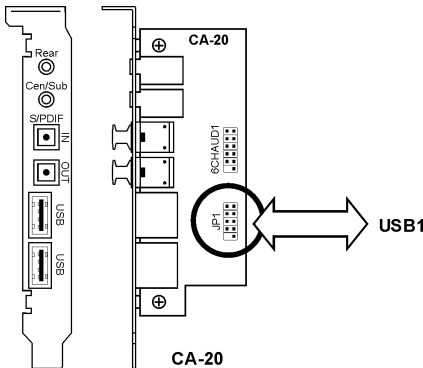

### 2.5.9. CD1, AUX1: Internal Audio Connector

These connectors connect to the audio output of internal CD-ROM drive or add-on audio card.

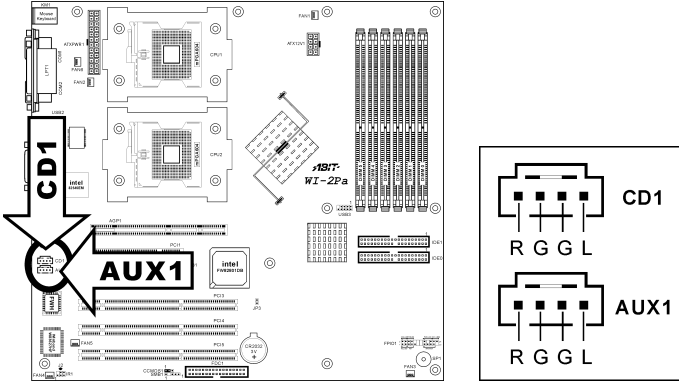



### 2.5.10. IR1: Infrared Device Header

This header connects to an optional IR device attached to chassis. This workstation board supports standard IR transfer rates.

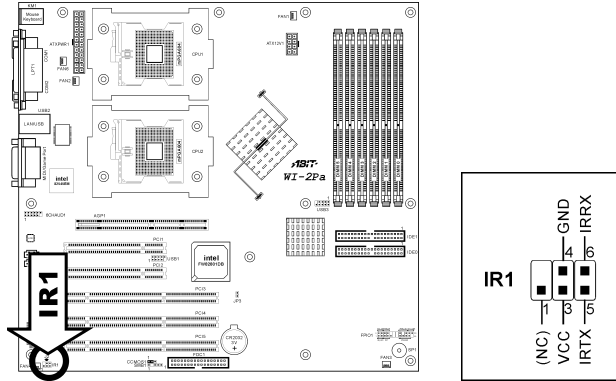

2.5.11. Back Panel Connectors:

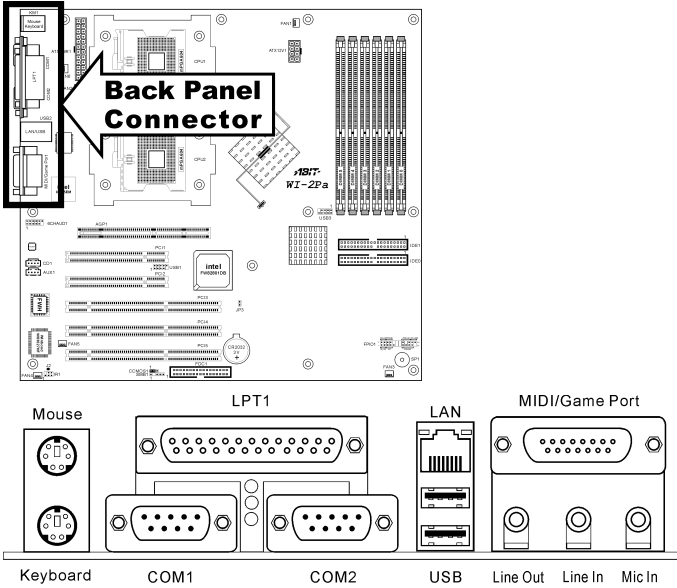

- **Mouse:** PS/2 mouse connector.
- **Keyboard:** PS/2 keyboard connector.
- **LPT:** Parallel port connector.
- **COM1/COM2:** Serial port connector
- **LAN:** Local Area Network connector.

Left LED	Right LED	Definition
Off	Off	No Connection
Green	Off	Link
Green	Blink Orange	Active

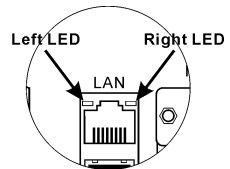

- **USB:** Universal Serial Bus connector.
- **MIDI/GAME Port:** Joystick, game pad, MIDI or other simulation hardware devices connector.
- **Line Out:** Audio output jack.
- **Line In:** Audio input jack.
- **Mic In:** Microphone input jack.

---

## Chapter 3. BIOS Setup

---

The BIOS is a program located in a Flash Memory chip on the workstation board. This program will not be lost when you turn the computer off. This program is also referred to as the boot program. It is the only channel the hardware circuit has to communicate with the operating system. Its main function is to manage the setup of the workstation board and interface card parameters, including simple parameters such as time, date, hard disk drive, as well as more complex parameters such as hardware synchronization, and device operating mode. The computer will operate normally, or will operate at its best, only if all of these parameters are correctly configured through the BIOS.

**Don't change the parameters inside the BIOS unless you fully understand its meanings and consequences:** The parameters inside the BIOS are used to setup the hardware synchronization or the device-operating mode. If the parameters are not correct, they will produce errors, the computer will crash, and sometimes you will not even be able to boot the computer after it has crashed. We recommend that you do not change the parameters inside the BIOS unless you are very familiar with them. If you are not able to boot your computer anymore, please refer to the section “**CMOS Memory Clearing Header**” in Chapter 2.

When you start the computer, the BIOS program controls it. The BIOS first operates an auto-diagnostic test called POST (Power On Self Test) for all of the necessary hardware. It then configures the parameters of the hardware synchronization, and detects all of the hardware. After these tasks are completed, the operating system (OS) give up control of the computer to the next level. Since the BIOS is the only channel for hardware and software to communicate, it is the key factor for system stability, and in ensuring that your system performs at its best. After the BIOS has achieved the auto-diagnostic and auto-detection operations, it will display the following message:

**PRESS DEL TO ENTER SETUP**

**NOTE:** As the BIOS menu is being constantly improved to increase system stability and performance; the BIOS screens in this manual may not completely match those of your BIOS version.

### 3.1. Main Menu

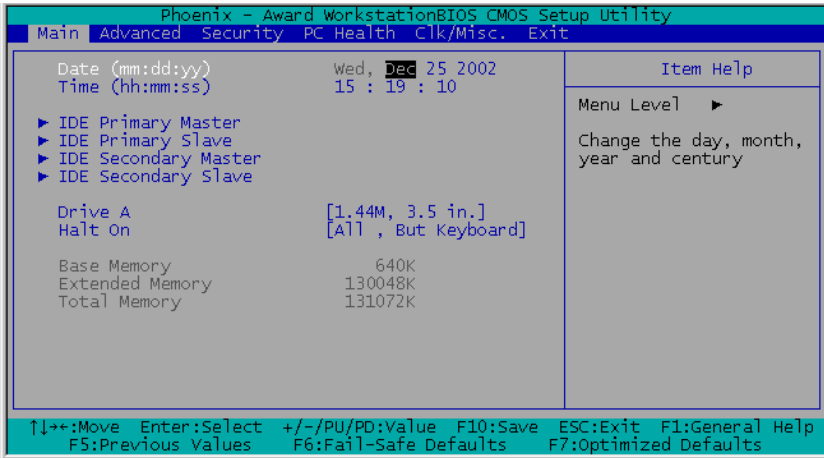

#### ***Date (mm:dd:yy)***

This item allows you to set the date you specify (usually the current date) in the format of [Month], [Date], and [Year]. Valid values are [Month]: January ~ December, [Date]: 1 ~ 31, and [Year]: 1999 ~ 2099. Use the <Tab> or <Enter> key to move between the fields.

#### ***Time (hh:mm:ss)***

This item allows you to set the time you specify (usually the current time) in the format of [Hour], [Minute], and [Second]. Valid values are [Hour]: 00 ~ 23, [Minute]: 00 ~ 59, and [Second]: 00 ~ 59. Use the <Tab> or <Enter> key to move between the fields.

#### ***IDE Primary Master, IDE Primary Slave, IDE Secondary Master, and IDE Secondary Slave***

Move cursor to item “IDE Primary Master”, “IDE Primary Slave”, “IDE Secondary Master” or “IDE Secondary Slave”, and then press <Enter> key to enter a sub-menu.

### IDE Primary/Secondary Master/Slave

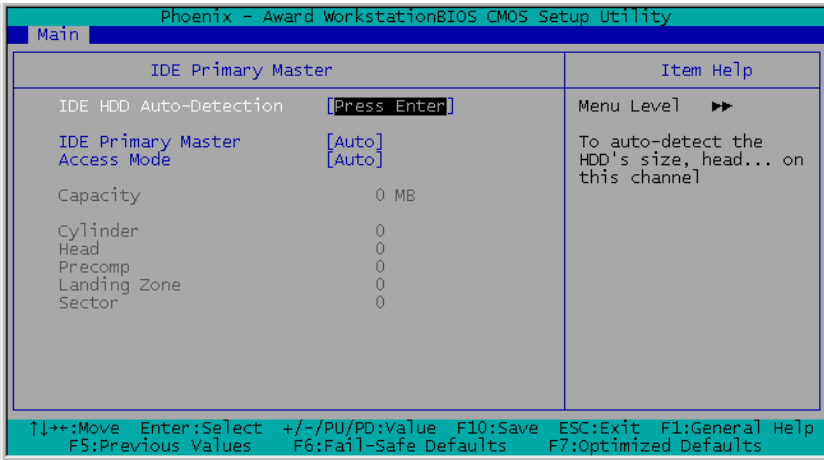

#### IDE HDD Auto-Detection

This item allows you to detect the parameters of IDE drives by pressing the <Enter> key. The parameters will automatically be shown on the screen.

#### IDE Primary Master

When set to [Auto], the BIOS will automatically check what kind of IDE drive you are using. If you want to define your own drive by yourself, set it to [Manual] and make sure you fully understand the meaning of the parameters. Refer to the manual provided by the device manufacturer to get the settings right.

#### Access Mode

This item selects the mode to access your IDE devices. Leave this item to its default [Auto] settings to let BIOS detect the access mode of your HDD and makes decision automatically.

#### Capacity

This item automatically displays your HDD size. Note that this size is usually slightly greater than the size given by a disk-checking program of a formatted disk.

**NOTE:** The following [Cylinder], [Head], [Precomp], [Landing Zone], and [Sector] items are available when you set the item "IDE Primary Master" to "Manual".

***Cylinder***

When disks are placed directly above one another along the shaft, the circular vertical “slice” consisting of all the tracks located in a particular position is called a cylinder. You can set the number of cylinders for a HDD. The minimum number you can enter is 0, the maximum number you can enter is 65535.

***Head***

This is the tiny electromagnetic coil and metal pole used to create and read back the magnetic patterns on the disk (also called the read/write head). You can configure the number of read/write heads. The minimum number you can enter is 0, the maximum number you can enter is 255.

***Precomp***

The minimum number you can enter is 0, the maximum number you can enter is 65535.

***Landing Zone***

This is a non-data area on the disk's inner cylinder where the heads can rest when the power is turned off. The minimum number you can enter is 0, the maximum number you can enter is 65535.

***Sector***

The minimum segment of track length that can be assigned to stored data. Sectors usually are grouped into blocks or logical blocks that function as the smallest units of data permit. You can configure this item to sectors per track. The minimum number you can enter is 0, the maximum number you can enter is 255.

***Drive A***

This item sets the type of floppy drives installed.

[None]: No floppy drive installed

[360K, 5.25 in.]: 5.25-inch standard drive; 360KB capacity

[1.2M, 5.25 in.]: 5.25-inch AT-type high-density drive; 1.2MB capacity

[720K, 3.5 in.]: 3.5-inch double-sided drive; 720KB capacity

[1.44M, 3.5 in.]: 3.5-inch double-sided drive; 1.44MB capacity

[2.88M, 3.5 in.]: 3.5-inch double-sided drive; 2.88MB capacity

***Halt On***

This item determines whether the system stops if an error is detected during system boot-up.

[All Errors]: The system-boot will stop whenever the BIOS detect a non-fatal error.

[No Errors]: The system-boot will not stop for any error detected.

[All, But Keyboard]: The system-boot will stop for all errors but keyboard error.

[All, But Diskette]: The system-boot will stop for all errors but disk error.

[All, But Disk/Key]: The system boot will stop for all errors but disk or keyboard error.

***Base Memory***

This item displays the amount of base memory installed in the system. The value of the base memory is typically 640K for system with 640K or more memory size installed on the motherboard.

***Extended Memory***

This item displays the amount of extended memory detected during system boot-up.

***Total Memory***

This item displays the total memory available in the system.

## 3.2. Advanced Menu

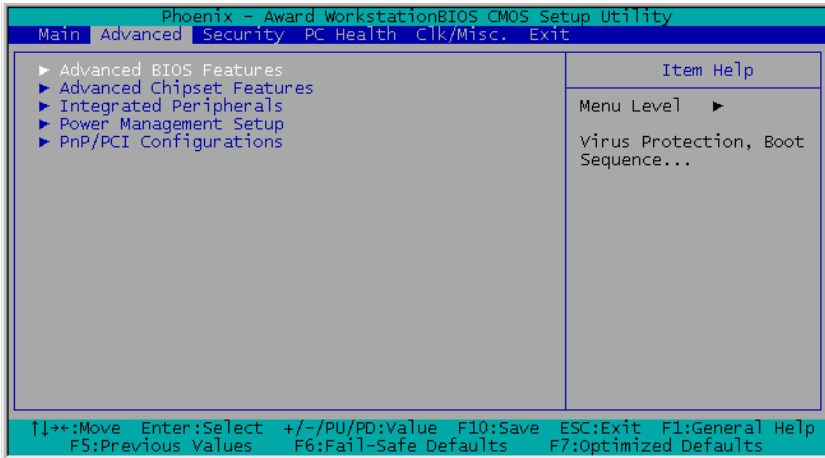

### 3.2.1. Advanced BIOS Features

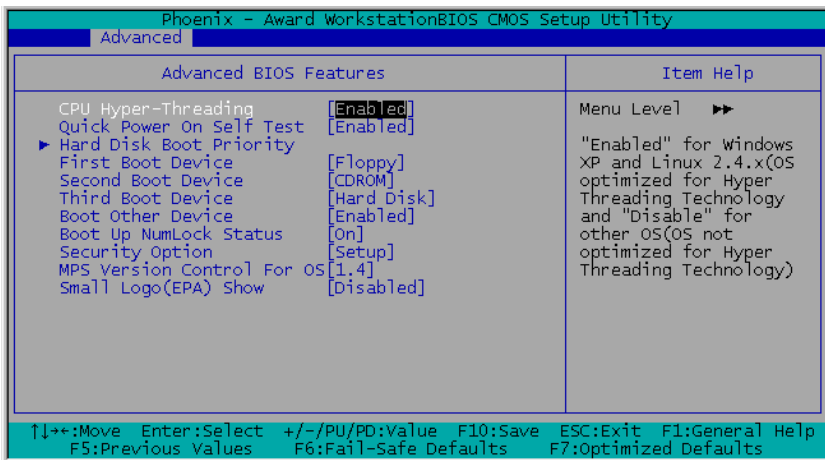

#### *CPU Hyper-Threading*

Leave this item to its default setting to enable the simultaneous multi-threaded (SMT) processor so as to make one physical processor looks like two logical processors to the OS and applications.



This option is for CPU with Hyper-Threading Technology only. For more information on “Hyper-Threading Technology”, please visit Intel Web site at <http://www.intel.com/homepage/land/hyperthreading.htm> , <http://www.intel.com/design/chipsets/ht/>.

### ***Quick Power On Self Test***

When set to [Enabled], this item speeds up the Power On Self Test (POST) after powering on the system. The BIOS shorten or skip some check during the POST.

### ***Hard Disk Boot Priority***

This item allows you to select the booting priority of hard disks.

### ***First Boot Device / Second Boot Device / Third Boot Device / Boot Other Device***

Select the drive to boot first, second and third in the [First Boot Device], [Second Boot Device], and [Third Boot Device] fields respectively. The BIOS will boot the operating system according to the sequence of the drive selected. Set [Boot Other Device] to [Enabled] if you wish to boot from another device other than these three items.

### ***Boot Up NumLock Status:***

This item allows you to determine the default state of the numeric keypad. When set to [On], the system boots up with NumLock on wherein the function of the numeric keypad is the number keys. When set to [Off], the function of the numeric keypad is the arrow keys.

### ***Security Option***

This option can be set to System or Setup. The default setting is **Setup**. After you have created a password through PASSWORD SETTING, this option will deny access to your system (System) or modification of computer setup (BIOS Setup) by unauthorized users.

**SYSTEM:** When you choose System, a password is required each time the computer boots up. If the correct password is not given, the system will not start.

**SETUP:** When you choose Setup, a password is required only when accessing the BIOS Setup. If the correct password is not given, you can't enter the BIOS setup menu.

To disable security, select *Set Supervisor Password* at main menu and then you will be asked to enter the password. Do not type anything and just press the <Enter> key and it will disable security. Once security is disabled, the system will boot and you can enter the *BIOS setup menu* freely

**NOTE:** Don't forget your password. If you forget the password, you will have to open the computer case and clear all information in the CMOS before you can start up the system. But by doing this, you will have to reset all previously set options.

***MPS Version Control For OS:***

This item specifies which version of MPS (Multi-Processor Specification) this workstation board will use. The options are 1.1 and 1.4. The default setting is **1.4**. If you use an older OS for dual processor executing, please set this option to 1.1.

***Small Logo(EPA) Show:***

This item determines to show the EPA logo when booting.

### 3.2.2. Advanced Chipset Features

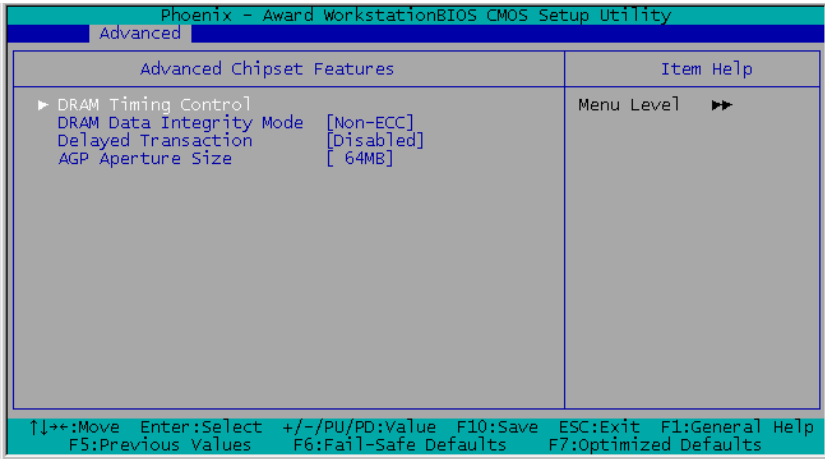

#### *DRAM Timing Control*

This item controls the DRAM timing. Press <Enter> key to enter its menu.

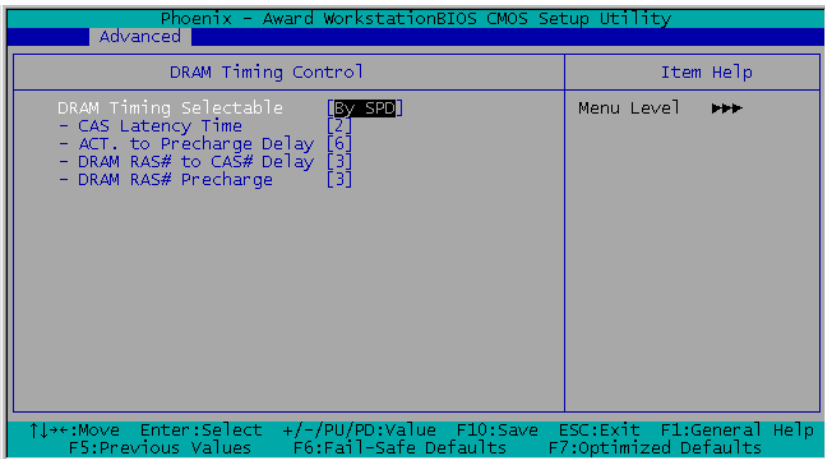

#### *DRAM Timing Selectable*

This item sets the optimal timings for the following four items, depending on the memory module you are using. The default setting "By SPD" configures these four

items by reading the contents in the SPD (Serial Presence Detect) device. The EEPROM on the memory module stores critical parameter information about the module, such as memory type, size, speed, voltage interface, and module banks.

### ***CAS Latency Time***

This item controls the latency between the DRAM read command and the time that the data becomes actually available.

### ***ACT. to Precharge Delay***

This item controls the number of DRAM clocks used for DRAM parameters.

### ***DRAM RAS# to CAS# Delay***

This item controls the latency between the DRAM active command and the read/write command.

### ***DRAM RAS# Precharge***

This item controls the idle clocks after issuing a precharge command to the DRAM.

### ***DRAM Data Integrity Mode***

Two options are available: ECC and Non-ECC. The default setting is *Non-ECC*. This option is used to configure the type of DRAM in your system. ECC is “Error Checking and Correction”. Choose the ECC option only when your memory is ECC type.

**NOTE:** When installed with Registered memory, the DRAM modules will be auto detected and this item will be grayed out for display only.

### ***Delayed Transaction***

Two options are available: Enabled and Disabled. The default setting is *Disabled*. Set the option to enabled or disabled PCI 2.1 features including passive release and delayed transaction for the chipset. This function is used to meet the latency of PCI cycles to or from the ISA bus. This option must be enabled to provide PCI 2.1 compliance. If you have an ISA card compatibility problem, you can try to enable or disable this option for optimal results.

### ***AGP Aperture Size***

This option specifies the amount of system memory that can be used by the AGP device. The aperture is a portion of the PCI memory address range dedicated for graphics memory address space. Host cycles that hit the aperture range are forwarded to the AGP without any translation. See [www.agpforum.org](http://www.agpforum.org) for AGP information.

### 3.2.3. Integrated Peripherals

In this menu, you can change the onboard I/O device, I/O port address and other hardware settings.

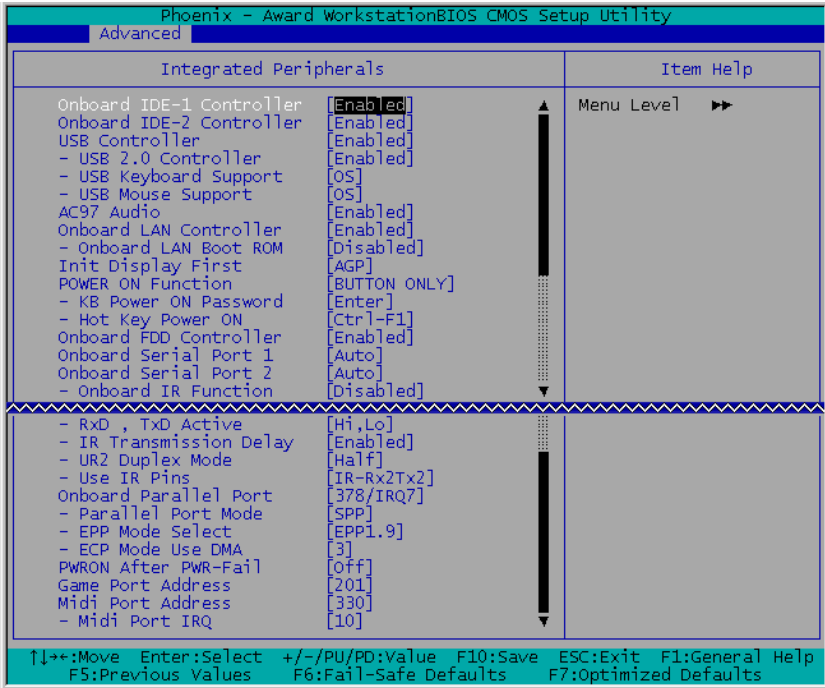

#### Onboard IDE-1 Controller

This item enables or disables the onboard IDE-1 controller.

#### Onboard IDE-2 Controller

Its description is the same as the *Onboard IDE-1 Controller*.

#### USB Controller

Two options are available: Enabled and Disabled. The default setting is **Enabled**. This workstation board provides two Universal Serial Bus (USB) ports to support USB devices. If you don't want to use USB devices, set it to *Disabled*, then the item *USB Keyboard Support & USB Mouse Support* will also be disabled.

### ***USB 2.0 Controller***

This item allows you to select the USB ports to be USB 2.0 ([Enabled]) or USB 1.1 ([Disabled]) specification.

### ***USB Keyboard Support***

This item allows you to select [**BIOS**] for using USB keyboard in DOS environment, or [**OS**] in OS environment.

### ***USB Mouse Support***

This item allows you to select [**BIOS**] for using USB mouse in DOS environment, or [**OS**] in OS environment.

### ***AC97 Audio***

When set to [**Enabled**], the onboard audio codec will be detected and supported. If you want to use audio adapter other than the one onboard, set this item to [**Disabled**]

### ***Onboard LAN Controller***

This item enables or disables the onboard LAN controller.

### ***Onboard LAN Boot ROM***

When set to [**Enabled**], this item allows the system to boot from network by the onboard LAN controller boot ROM.

### ***Init Display First***

Two options are available: PCI Slot and AGP. The default setting is **AGP**. When you install an additional display card, you can choose either a PCI display card or an AGP display card to activate the display boot-up screen.

### ***POWER ON Function***

This item allows you to select which way you want your system to power on. Seven items are available: Password → Hot Key → Mouse Left → Mouse Right → Any Key → **BUTTON ONLY** → Keyboard 98. The default setting is **BUTTON ONLY**.

**NOTE:** The mouse wake up function can only be used with the PS/2 mouse, not with a mouse that uses the COM port and USB connection. *Mouse Left (Mouse Right)* means you need to double click the mouse *left (right)* button, for the computer to power on. You also need to note the compatibility issue with your PS/2 mouse. Some PS/2 mice cannot wake up the system because of compatibility problems. Also, if the specs of your keyboard are too old, it may fail to power on.

### ***KB Power ON Password***

This option allows you to set a password required in order to Power ON your computer. You will be asked to enter your password and then to confirm it. Do not forget your password. Should you forget your password, you will have to open your computer case, clear the CMOS and reset all parameters again in order to be able to utilize this function.

### ***Hot Key Power ON***

There are twelve options are available, Ctrl-F1 to Ctrl-F12. You can select this item and using the <Ctrl> plus the one of each function key (F1 to F12) to power on the computer.

### ***Onboard FDD Controller***

This item enables or disables the onboard FDD controller.

### ***Onboard Serial Port 1***

This item specifies the I/O address and IRQ of Serial Port 1.

### ***Onboard Serial Port 2***

This item specifies the I/O address and IRQ of Serial Port 2.

### ***Onboard IR Function***

This item enables or disables the onboard IR function. The options are: IrDA (HPSIR) mode → ASK IR (Amplitude Shift Keyed IR) mode → Disabled.

### ***RxD , TxD Active***

Four options are available: Hi, Hi → Hi, Lo → Lo, Hi → Lo, Lo. The default setting is **Hi, Lo**. Set IR transmission/reception polarity as High or Low.

### ***IR Transmission Delay***

Two options are available: Enabled and Disabled. The default setting is **Enabled**. Set IR transmission delays 4 character-time (40 bit-time) when SIR is changed from RX mode to TX mode.

### ***UR2 Duplex Mode***

Two options are available: Full and Half. The default setting is **Half**. This item lets you choose the operation mode for your IR KIT. Some IR device only can work at half duplex mode. Refer to your IR KIT user's guide to find out which setting is correct.

### ***Use IR Pins***

Two options are available: RxD2, TxD2 and IR-Rx2Tx2. The default setting is ***IR-Rx2Tx2***. If you choose *RxD2, TxD2*, your workstation board must support a COM port IR KIT connection. Otherwise, you can only choose the *IR-Rx2Tx2* to use the IR header on your workstation board to connect your IR KIT. Please use the default setting.

### ***Onboard Parallel Port***

This item sets the address of the onboard parallel port.

### ***Parallel Port Mode***

This item sets the operation mode of the parallel port. [***SPP***] (Standard Parallel Port) allows bi-directional parallel port operation at normal speed; [***ECP***] (Extended Capabilities Port) allows bi-directional parallel port operation at a speed faster than the normal mode's data transfer rate; [***EPP***] (Enhanced Parallel Port) allows bi-directional parallel port operation at maximum speed.

### ***EPP Mode Select***

This item selects the EPP mode.

### ***ECP Mode Use DMA***

Two options are available: 1 → 3. The default setting is **3**. When the mode selected for the parallel port mode is ECP, the DMA channel selected can be Channel 1 or Channel 3.

### ***PWRON After PWR-Fail***

This item sets the system action after a power failure.

### ***Game Port Address***

This item sets the address of the onboard game port connector.

### ***Midi Port Address***

This item sets the address of the onboard midi port connector.

### ***Midi Port IRQ***

This item sets the IRQ of the onboard midi port connector. If you choose disable the *Midi Port Address*, then this field is not available.



---

---

**NOTE:** If you bought an audio adapter and wanted to replace the use of onboard audio solution, you have to disable three items in BIOS. Otherwise, your audio adapter may not work well. These three items are:

AC 97 Audio: set to *Disabled*

Game Port Address: set to *Disabled*

Midi Port Address: set to *Disabled*

### 3.2.4. Power Management Setup

This menu allows you to set up the power management in order to reduce power consumption.

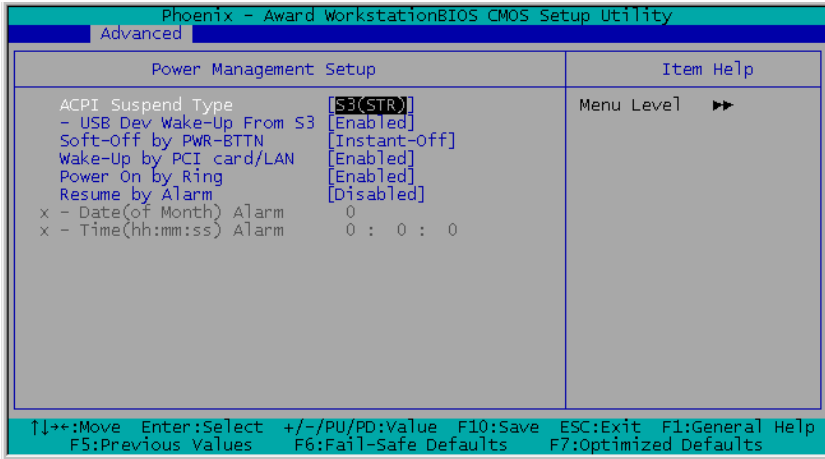

#### **ACPI Suspend Type:**

Two options are available: S1(POS) and S3(STR). The default setting is **S3(STR)**. Generally, ACPI has six states: System S0 state, S1, S2, S3, S4, S5. S1 and S3 states are described below:

#### **The S1(POS) State (Power On Suspend):**

While the system is in the S1 sleeping state, its behavior is as described below:

- The processor is not executing instructions. The processor's complex context is maintained.
- Dynamic RAM context is maintained.
- Power Resources are in a state compatible with the system S1 state. All Power Resources that supply a System Level reference of S0 are in the OFF state.
- Devices states are compatible with the current Power Resource states. Only devices which solely reference Power Resources which are in the ON state for a given device state can be in that device state. In all other cases, the device is in the D3 (off) state.

- Devices that are enabled to wake the system and that can do so from their current device state can initiate a hardware event which transitions the system state to S0. This transition causes the processor to continue execution where it left off.

To transition into the S1 state, the operating software does not have to flush the processor's cache.

### **The S3(STR) State (Suspend to RAM):**

The S3 state is logically lower than the S2 state and is assumed to conserve more power. The behavior of this state is defined as follows:

- Processor is not executing instructions. The processor complex context is not maintained.
- Dynamic RAM context is maintained.
- Power Resources are in a state compatible with the system S3 state. All Power Resources that supply a System Level reference of S0, S1, or S2 are in the OFF state.
- Devices states are compatible with the current Power Resource states. Only devices which solely reference Power Resources which are in the ON state for a given device state can be in that device state. In all other cases, the device is in the D3 (off) state.
- Devices that are enabled to wake the system and that can do so from their current device state can initiate a hardware event which transitions the system state to S0. This transition causes the processor to begin execution at its boot location. The BIOS performs initialization of core functions as required to exit an S3 state and passes control to the firmware resume vector. Please see the ACPI Specification Rev. 1.0 book section 9.3.2 for more details on BIOS initialization.

From the software point of view, this state is functionally the same as the S2 state. The operational difference can be that some Power Resources that could be left ON in the S2 state might not be available to the S3 state. As such, additional devices can be required to be in logically lower D0, D1, D2, or D3 state for S3 than S2. Similarly, some device wake events can function in S2 but not S3.

Because the processor context can be lost while in the S3 state, the transition to the S3 state requires that the operating software flush all dirty cache to DRAM.

- **The information above for system S0 & S3 were referring to ACPI Specification.**

### ***USB Dev Wake-Up From S3***

When set to [***Enabled***] this item allows you to use USB keyboard to wake up a system that is in the S3 state. This item can be configured only if the “ACPI Suspend Type” item is set to [***S3(STR)***].

### ***Soft-Off by PWR-BTTN***

This item selects the method of powering off your system:

[***Hold 4 Sec.***]: Pushing the power button for more than 4 seconds will power off the system. This will prevent the system from powering off in case you accidentally hit or pushed the power button.

[***Instant-Off***]: Pressing and then releasing the power button at once will immediately power off the system.

### ***Wake-Up by PCI card/LAN***

Two options are available: Enabled and Disabled. Default setting is ***Enabled***. This item allows you to wake up your computer by PCI devices. For instance, if you had installed a PCI LAN card with Wake-Up on LAN capability, then you could wake-up your computer from another computer via a network by sending a wake-up frame signal. This feature also allows the PCI card built-in hardware function to support the wake up function without special cables connected to the workstation board.

**NOTE:** This feature needs a specific network interface (optional). Also your power supply +5V standby power must be at least 720mA compatible.

### ***Power On by Ring***

Two options are available: Enabled and Disabled. Default setting is ***Enabled***. If you connect an external modem to the onboard serial port, the system will be turned on when a telephone ring-up occurs.

### ***Resume by Alarm***

When set to [***Enabled***], you can set the date and time you would like the Soft-Off PC to power-on in the “***Date (of Month) Alarm***” and “***Time (hh:mm:ss) Alarm***” items. However, if the system is being accessed by incoming calls or the network (Resume On Ring/LAN) prior to the date and time set in these items, the system will give priority to the incoming calls or network instead.

### ***Date (of Month) Alarm***

[***0***]: This option power-on the system everyday according to the time set in the “***Time (hh:mm:ss) Alarm***” item.

[I-3I]: This option selects a date you would like the system to power-on. The system will power-on on the date set, and the time set in the “Time (hh:mm:ss) Alarm” item.

***Time (hh:mm:ss) Alarm***

This item sets the time you would like the system to power-on.

### 3.2.5. PnP/PCI Configurations

This section describes configuring the PCI bus system. PCI, or Personal Computer Interconnect, is a system that allows I/O devices to operate at speeds nearing the speed the CPU itself uses when communicating with its own special components. This section covers some very technical items and it is strongly recommended that only experienced users should make any changes to the default settings.

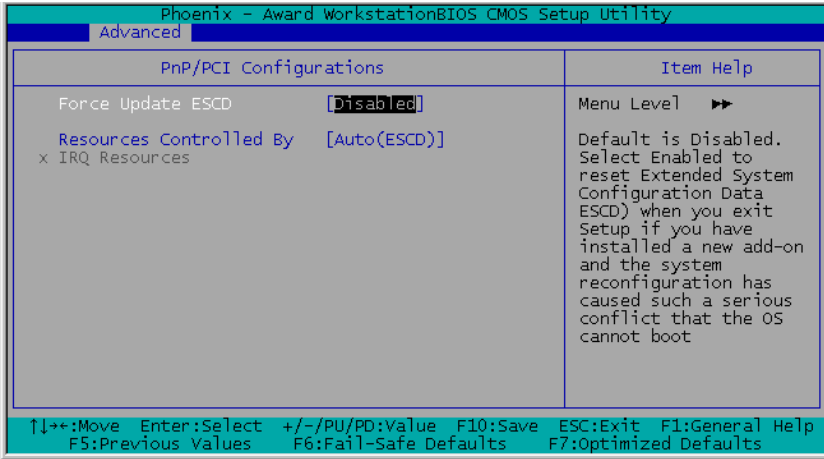

#### ***Force Update ESCD***

If you want to clear ESCD data next time you boot up, and ask the BIOS to reset the settings for the Plug & Play ISA Card and the PCI Card, select Enabled. But the next time you boot up, this option will automatically be set as Disabled.

#### ***Resources Controlled By***

The Award Plug and Play BIOS has the capability to automatically configure all of the boot and Plug and Play compatible devices. If you select *Auto (ESCD)*, The IRQ Resources item will be disabled, as the BIOS automatically assigns them. But if you have trouble in assigning the interrupt resources automatically, you can select *Manual* to set which IRQ is assigned to PCI PnP cards.

The following figure shows you the screen of IRQ resources. Each item has two options: PCI Device and Reserved. The default setting is *PCI Device*.

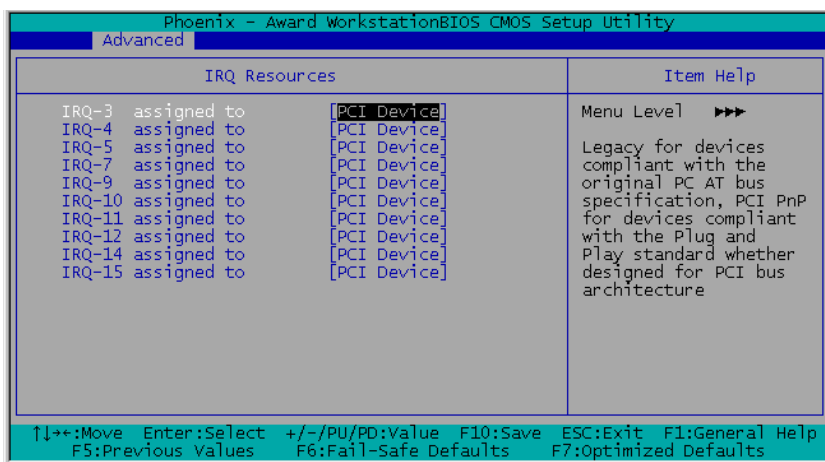

### 3.3. Security Menu

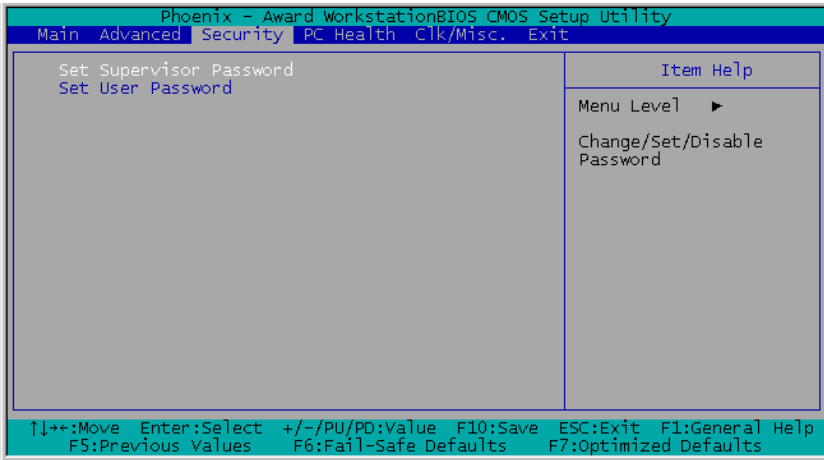

#### ***Set Supervisor Password***

This option protects the BIOS configuration or restricts access to the computer itself. The Supervisor Password is used to protect the stored CMOS options from being changed by unauthorized users.

#### ***Set User Password***

This option protects the BIOS configuration or restricts access to the computer itself. The User Password requires all users to enter a password in order to use the system, and/or enter the BIOS setup (but can't change its contents).



### 3.4. PC Health Menu

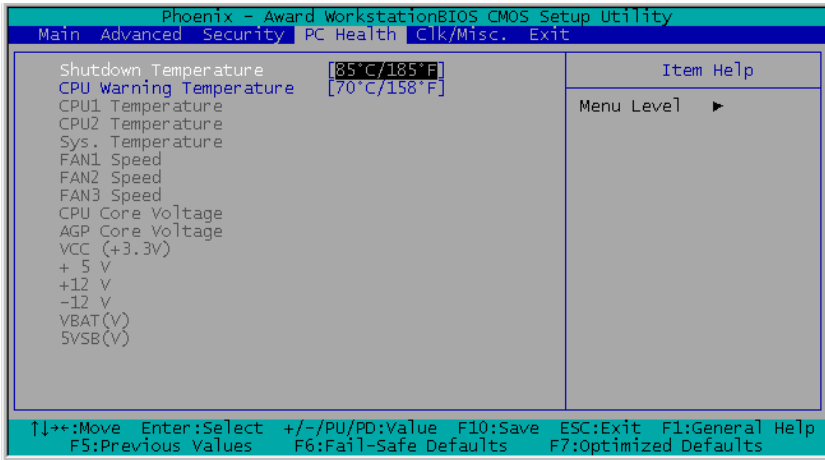

#### ***CPU Shutdown Temperature:***

Once the system or CPU temperature exceeds the temperature specified, the CPU will shutdown automatically to avoid damaging. This function only works for an ACPI OS such as Windows 98/ Windows 2000 with ACPI activated. The options are Disabled, 70°C/158°F, 75°C/167°F, 80°C/176°F, and 85°C/185°F. The default setting is **85°C/185°F**.

**NOTE:** This item is enabled only for 604-pin CPU. For 603-pin CPU, the CPU will be auto detected and this item will be disappeared.

#### ***CPU Warning Temperature***

This item lets you select the temperature at which you want the system to send out a warning message to the PC speakers of when the temperature goes beyond either limit. You can select the temperatures you want. The options are Disabled, 50°C/122°F, 53°C/127°F, 56°C/133°F, 60°C/140°F, 63°C/145°F, 66°C/151°F, and 70°C/158°F. The default setting is **70°C/158°F**.

**NOTE:** This item is enabled only for 604-pin CPU. For 603-pin CPU, the CPU will be auto detected and this item will be disappeared.

### *All Voltages, Fans Speed and Thermal Monitoring*

These unchangeable items list the current status of the CPU and environment temperatures, fan speeds, and system power voltage. (The FAN4~6 header does not support speed monitoring.)

**NOTE:** The hardware monitoring features for temperatures, fans and voltages will occupy the I/O address from 294H to 297H. If you have a network adapter, sound card or other add-on cards that might use those I/O addresses, please adjust your add-on card I/O address to avoid using these addresses.

### 3.5. Clk/Misc. Menu

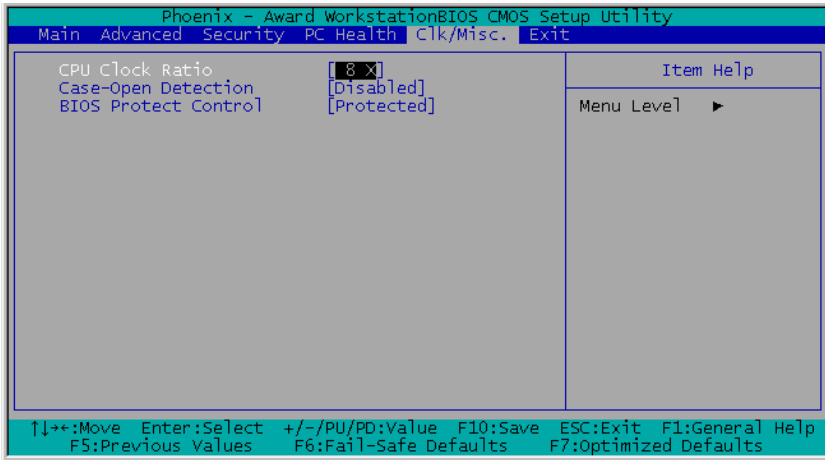

#### ***CPU Clock Ratio***

This option selects the CPU clock ratio. Please type in the correct multiple for your CPU.

#### ***Case-Open Detection***

This option controls the function for case-opening detection via JP3 header.

#### ***BIOS Protect Control***

This option protects for accidentally BIOS writing attempt.

**NOTE:** Make sure to set this item to "Unprotected" when flashing the BIOS.

### 3.6. Exit Menu

Once you have made all your selections in the previous BIOS setup menu, you have to save the settings and exit the setup menu. Select the Exit Menu in the menu bar to show the following menu:

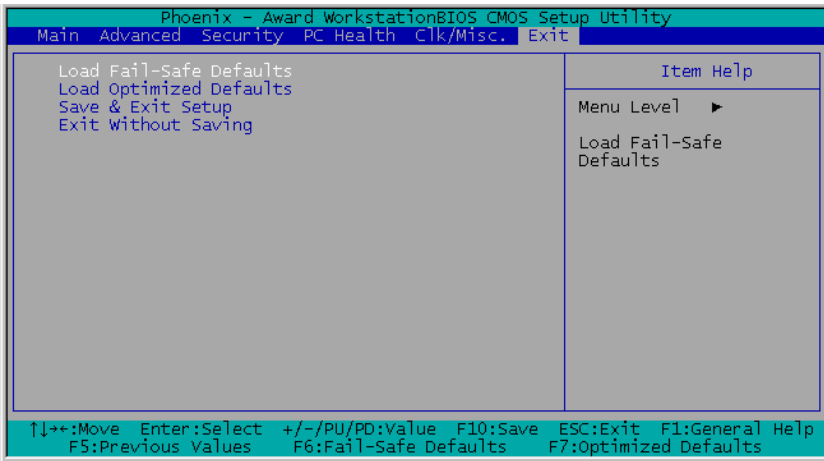

**NOTE:** Pressing <ESC> does not exit this menu. You have to select one of the options in this menu, such as “Exit Without Saving” to exit the menu without saving your previous settings.

#### ***Load Fail-Safe Defaults***

This option loads the BIOS default values for the most stable, minimal-performance system operations.

#### ***Load Optimized Defaults***

This option loads the BIOS default values that are factory settings for optimal-performance system operations.

#### ***Save & Exit Setup***

This option saves your selections and exits the setup menu.

#### ***Exit Without Saving***

This option exits the setup menu without saving any change.

## Chapter 4. Driver Installation

After all the hardware has been installed, you must first install the operating system and then the software drivers. The necessary drivers are all included within the Drivers & Utilities CD that came packaged with your workstation board.

The display shown in the following figure should appear after inserting this CD into your CD-ROM drive, if not, enter → [My Computer] → CD-ROM drive → double click [Launch].

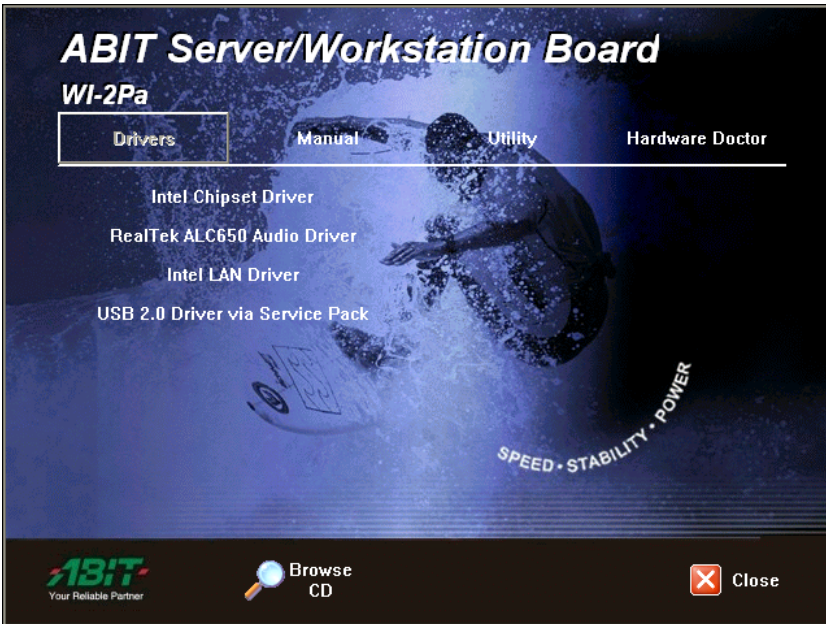

## *Setup Items*

- **Intel Chipset Driver**  
Install Intel chipset driver for Windows Operating System.
- **RealTek ALC650 Audio Driver**  
Install RealTek 6-Channel AC 97 CODEC driver for Windows Operating System.
- **Intel LAN Driver**  
Install the drivers needed to run Fast Ethernet controller. The operating systems supported are Windows, Windows XP 64-bit, Linux, Netware, and FreeBSD.
- **USB 2.0 Driver via Service Pack**  
Install USB 2.0 driver for Windows Operating System.
- **Manual**  
View the user's manual in PDF.
- **Utility**  
Click to enter a sub-screen for installing Acrobat Reader, Award Flash, DirectX, and LoFormat Utility software.
- **Hardware Doctor**  
A self-diagnostic system to protect hardware by monitoring several critical items including fan speed, voltages, CPU and system temperature. (Only supported in the Xeon processor type of 604-pin package)
- **Browse CD**  
Browse the contents of this CD-ROM.
- **Close**  
Exit the CD setup items.

---

## Appendix A. Trouble Shooting

---

### *Why the system shows incorrect CPU speed in Win2K*

If you run Minfo32.exe on a computer that has an Intel Pentium 4 Xeon 2.2-GHz or faster processor, a very high processor speed may be shown. The Processor information on the System Summary page shows the correct name, family, model and stepping for the processor, but the approximate speed may be 37,000 MHz or faster.

This is because the speed of the newest Pentium processors exposes a limitation in the speed calculation code in Minfo32.exe.

To resolve this problem, refer to the hotfix described in the Microsoft Knowledge Base article: "[Q302857](#) WMI Win32\_Group ASSOCIATORS Queries Are Not Optimized".

### *How to improve system performance for RedHat 7.2 and RedHat 7.3*

It is recommended to upgrade RedHat 7.2 to version 7.3, since there are many improvements as well as kernel upgrade. Currently there is limitation about multi-processor handling irq in RedHat 7.3. It is suggested to download the latest kernel in order to improve the performance. The latest kernel 2.4.18 need patch to fix multi-processor handle irq limitation. Please use the following steps to build the kernel.

Download the latest kernel from <http://www.kernel.org>, for example:

```
linux-2.4.18.tar.gz .
```

```
# mv linux-2.4.18.tar.gz /usr/src
```

```
# gunzip linux-2.4.18.tar.gz (unpack the kernel)
```

```
# tar xvf linux-2.4.18.tar (extract form kernel tar file)
```

```
# patch -p0 < irq.patch (update necessary patch)
```

```
# cd linux
```

```
# make mrproper
```

```
# make xconfig
```

```
# make dep
```

```
# make clean
```

```
# make bzImage
```

```
# cp /usr/src/linux/arch/i386/boot/bzImage /boot/vmlinuz-24188irqbal
```

```
# make modules
```

```
# make modules_install
# mkdinitrd /boot/initrd.2.4.18.img 2.4.18
# cp /usr/src/linux/System.map /boot/System.map-2.4.18-irqbal
# cd /boot
# ln -s System.map-2.4.18-irqbal System.map
# add following entries to /etc/lilo.conf

    image=/boot/vmlinuz-24188irqbal
        label=lin24188irqbal
        initrd=/boot/initrd-2.4.18.img
        read-only
        root=/dev/hda2

# lilo

# reboot
```

### ***How to access system memory in excess of 4GB for Microsoft Windows 2000 Advanced Workstation and Datacenter Workstation***

Microsoft Windows 2000 Advanced Workstation and Datacenter Workstation support memory in excess of 4GB of RAM by way of the Intel Physical Addressing Extension (PAE) specification. Windows 2000 Advanced Workstation is limited to 8GB, and Windows 2000 Datacenter Workstation is limited to 64GB.

You can enable PAE in the “Boot.ini” file. To enable PAE, follow these steps:

1. Locate the Boot.ini file, typically in the root folder (for example, C:) and remove its read-only attribute.
2. Open the Boot.ini file, and then add the **/PAE** parameter to the ARC path, as shown in bold format in the following example:

```
multi(0)disk(0)rdisk(0)partition(2)\WINNT= “Windows 2000 Advanced Workstation” /PAE /basevideo /sos
```

3. On the **File** menu, click **Save**.
4. Restore the read-only attribute to the Boot.ini file.



Even with PAE enabled, the underlying architecture of the system is still based on 32-bit linear addresses. This effectively retains the 2GB of application space and the 2GB of kernel mode space because only 4GB of addresses are available. However, multiple processes can immediately benefit from the increased RAM because they are less likely to encounter physical memory restrictions and begin paging. Additionally, applications can be modified to use the AWE API to allocate memory outside of the applications process space, bypassing the 2-GB limit for applications.



---

## **Appendix B. How to Get Technical Support**

---

(From our website) <http://www.abit.com.tw>

(In North America) <http://www.abit-usa.com>

(In Europe) <http://www.abit.nl>

Thank you for choosing ABIT products. ABIT sells all our products through distributors, resellers and system integrators; we have no direct sales to end-users. Before sending email for tech support please check with your resellers or integrators if you need any services, they are the ones who sold you your system and they should know best as to what can be done, how they serve you is a good reference for future purchases.

We appreciate every customer and would like to provide the best service to you. Providing fast service to our customers is our top priority. However we receive many phone calls and a huge amount of email from all over the world. At the present time it is impossible for us to respond to every single inquiry. Therefore it is quite possible that if you send an email to us that you may not receive a response.

We have done many compatibility tests and reliability tests to make sure our products have the best quality and compatibility. In case you need service or technical support, please understand the constraint we have and **always check with the reseller who sold the product to you first.**

To expedite service, we recommend that you follow the procedures outlined below before contacting us. With your help, we can meet our commitment to provide the best service to the **greatest number of ABIT customers:**

- 1. Check the Manual.** It sounds simple but we have taken a lot of care in making a well-written and thorough manual. It is full of information that doesn't only pertain to motherboards. The CD-ROM included with your board will have the manual as well as drivers. If you don't have either one, go to our Program Download Area of the Website or FTP workstation.
- 2. Download latest BIOS, software or drivers.** Please go to our Program Download area on our Website to check to see if you have the latest BIOS. They are developed over periods of time to fix bugs or incompatibilities. **Also please make sure you have the latest drivers from your peripheral cards makers!**
- 3. Check the ABIT Technical Terms Guide and FAQ on our Website.** We are trying to expand and make the FAQs more helpful and information rich. Let us know if you have any suggestions. For hot topics check out our HOT FAQ!

4. **Internet Newsgroups.** They are a great source of information and many people there can offer help. ABIT's Internet News group, [alt.comp.periphs.mainboard.abit](mailto:alt.comp.periphs.mainboard.abit), is an ideal forum for the public to exchange information and discuss experiences they have had with ABIT products. Many times you will see that your question has already been asked before. This is a public Internet news group and it is reserved for free discussions. Here is a list of some of the more popular ones:

[alt.comp.periphs.mainboard.abit](mailto:alt.comp.periphs.mainboard.abit)  
[comp.sys.ibm.pc.hardware.chips](mailto:comp.sys.ibm.pc.hardware.chips)  
[alt.comp.hardware.overclocking](mailto:alt.comp.hardware.overclocking)  
[alt.comp.hardware.homebuilt](mailto:alt.comp.hardware.homebuilt)  
[alt.comp.hardware.pc-homebuilt](mailto:alt.comp.hardware.pc-homebuilt)

5. **Ask your reseller.** Your ABIT authorized distributor should be able to provide the fastest solution to your technical problem. We sell our products through distributors who sell to resellers and stores. Your reseller should be very familiar with your system configuration and should be able to solve your problem much more efficiently than we could. After all, your reseller regards you as an important customer who may purchase more products and who can urge your friends to buy from him or her as well. They integrated and sold the system to you. They should know best what your system configuration is and your problem. They should have reasonable return or refund policies. How they serve you is also a good reference for your next purchase.
6. **Contacting ABIT.** If you feel that you need to contact ABIT directly you can send email to the ABIT technical support department. First, please contact the support team for the branch office closest to you. They will be more familiar with local conditions and problems and will have better insight as to which resellers offer what products and services. Due to the huge number of emails coming in every day and other reasons, such as the time required for problem reproduction, we will not be able to reply to every email. Please understand that we are selling through distribution channels and don't have the resources to serve every end-user. However, we will try to do our best to help every customer. Please also remember that for many of our technical support team English is a second language, you will have a better chance of getting a helpful answer if your question can be understood in the first place. Be sure to use very, simple, concise language that clearly states the problem, avoid rambling or flowery language and always list your system components. Here is the contact information for our branch offices:

***North America and South America:***

**ABIT Computer (U.S.A.) Corporation**

45531 Northport Loop West,  
Fremont, California 94538, U.S.A.

Tel: 1-510-623-0500

Fax: 1-510-623-1092

[sales@abit-usa.com](mailto:sales@abit-usa.com)

[technical@abit-usa.com](mailto:technical@abit-usa.com)

***U.K. and Ireland:***

**ABIT Computer (U.K.) Corporation Ltd.**

Unit 3, 24-26 Boulton Road,  
Stevenage, Herts SG1 4QX, U.K.

Tel: 44-1438-228888

Fax: 44-1438-226333

[sales@abitcomputer.co.uk](mailto:sales@abitcomputer.co.uk)

[technical@abitcomputer.co.uk](mailto:technical@abitcomputer.co.uk)

***Germany, Benelux (Belgium, Netherlands, Luxembourg),  
Denmark, Norway, Sweden, Finland, and Switzerland:***

**AMOR Computer B.V. (ABIT's European Office)**

Van Coehoornstraat 7,  
5916 PH Venlo, The Netherlands

Tel: 31-77-3204428

Fax: 31-77-3204420

[sales@abit.nl](mailto:sales@abit.nl)

[technical@abit.nl](mailto:technical@abit.nl)

***Austria, Czech, Romania, Bulgaria, Yugoslavia, Slovakia,  
Slovenia, Croatia, Bosnia and Serbia:***

**Asguard Computer Ges.m.b.H**

Schmalbachstrasse 5,  
A-2201 Gerasdorf/wien, Austria

Tel: 43-1-7346709

Fax: 43-1-7346713

[asguard@asguard.at](mailto:asguard@asguard.at)

***Japan:***

**ABIT Computer (Japan) Co. Ltd.**

Fax: 81-3-5396-5110

<http://www.abit4u.jp>

***Shanghai:***

**ABIT Computer (Shanghai) Co. Ltd.**

Tel: 86-21-6235-1829

Fax: 86-21-6235-1832

<http://www.abit.com.cn>

***Russia:***

**ABIT Computer (Russia) Corporation Ltd.**

Fax: 7 (095) 937 8237

<http://www.abit.ru>

***France:***

**ABIT Computer France SARL**

4, Place La Defense,

92974 Paris La Defense cedex, France

Fax: 33-1-5858-0047

<http://www.abit.com.tw>

***All other territories not covered above please contact***

***Taiwan Head Office:***

When contacting our headquarters please Note we are located in Taiwan and we are 8+ GMT time. In addition, we have holidays that may be different from those in your country.

**ABIT Computer Corporation**

No.323, YangGuang St., Neihu,

Taipei, 114, Taiwan

Tel: 886-2-8751-8888

Fax: 886-2-8751-3381

[workstation\\_sales@abit.com.tw](mailto:workstation_sales@abit.com.tw)

[market@abit.com.tw](mailto:market@abit.com.tw)

[technical@abit.com.tw](mailto:technical@abit.com.tw)

<http://www.abit.com.tw>

7. **RMA Service.** If your system has been working but it just stopped, but you have not installed any new software or hardware recently, it is likely that you have a defective component. Please contact the reseller from whom you bought the product. You should be able to get RMA service there.
  
8. **Reporting Compatibility Problems to ABIT.** Because of tremendous number of email messages we receive every day, we are forced to give greater weight to certain types of messages than to others. For this reason, any compatibility problem that is reported to us, giving detailed system configuration information and error symptoms will receive the highest priority. For the other questions, we regret that we may not be able to reply directly. But your questions may be posted to the Internet news group in order that a larger number of users can have the benefit of the information. Please check the news group from time to time.

**Thank You**

**ABIT Computer Corporation**

**<http://www.abit.com.tw>**



## Technical Support Form

**Company Name:**

**Phone Number:**

**Contact Person:**

**Fax Number:**

**E-mail Address:**

Model	*	BIOS ID #	*
Motherboard Model No.		DRIVER REV	
OS/Application	*		
Hardware Name	Brand	Specifications	
CPU	*		
HDD	<input type="checkbox"/> IDE1 <input type="checkbox"/> IDE2		
CD-ROM-Drive	<input type="checkbox"/> IDE1 <input type="checkbox"/> IDE2		
System Memory			
ADD-ON CARD			

Problem Description:

---



---



---



---



---



---



---



---



---



---

