

P4M-800T



MAINBOARD MANUAL

DOC No.: M03504

Rev. : A0

Date : 7, 2003

Part No. : 25-10671-00



Table of Contents

Chapter 1 Overview

Package Checklist	1-2
The P4M-800T Mainboard	1-3
Main Features	1-4
FIC Unique Innovation for Users (NOVUS) -	
Enhanced Mainboard Features and System Support	1-6

Chapter 2 Installation Procedures

1). Set System Jumpers	2-2
Clear CMOS	2-2
BIOS Anti-Reflash Protect	2-3
2). Install Memory Modules	2-3
3). Install the CPU	2-4
Connect ATX Power	2-6
4). Install Expansion Cards	2-7
5). Connect Devices	2-8
Floppy Diskette Drive Connector	2-8
IDE Device Connectors	2-9
Fan Connectors	2-9
Power Connectors	2-10
Front Panel Block, Power LED, IR, and Speaker Connector	2-11
CD Audio-In Connectors	2-12
IEEE 1394 Connectors (mfg. optional)	2-12
Serial IRQ Connector	2-13
Serial ATA Connectors	2-13
PS/2 Keyboard and Mouse Connector	2-14
RJ45 LAN Connector	2-14
Serial Port Connectors	2-15
Printer Connector	2-15
Audio I/O Jacks	2-16
Front Audio Connector	2-16
Universal Serial Bus Connectors	2-17

Chapter 3 BIOS Setup

CMOS Setup Utility	3-1
Standard CMOS Setup	3-2
Advanced BIOS Features	3-4
Advanced Chipset Features	3-7
Integrated Peripherals	3-10
Power Management Setup	3-14
PnP/PCI Configurations	3-18
PC Health Status	3-20
Frequency/Voltage Control	3-21
Load Fail-Safe Defaults	3-21
Load Optimized Defaults	3-22
Supervisor/User Password	3-22
Save and Exit Setup	3-22
Exit without Saving	3-22

Quick Reference (German)

Quick Reference (French)

Quick Reference (Spanish)

Quick Reference (Japanese)

Quick Reference (Chinese)

Quick Reference (Simplified Chinese)

Overview

The new microATX, 478-pin 1stMainboard® supports a full range of the latest generation Intel® Pentium® 4 processors. The leading edge VIA® PT800 (PT800 with 8237) chipset was designed for coworking with Pentium® 4 (up to 3.06 GHz) in the 478-pin package based on the VRM 9.0 spec and 400/533/800 MHz. Built using the leading edge technology the Intel Pentium® 4 processors provide a significant performance over previous Pentium® III processors. Two DDR 266/333/400 SDRAM sockets allow for up to 2 GB memory capacity. Support for the Ultra DMA/133 protocol and its high-speed interface further ensures that data transfer speeds are improved, especially for long sequential transfers required by audio/visual applications.

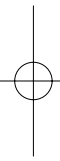

The board features onboard audio and LAN function; also, the serial ATA feature replaces the standard parallel ATA physical storage interface and allows future enhancements to the computing platform. It completely software compatible with parallel ATA, requiring no modification to your operating system. For more detail, please read the help file in the 1st Utilities CD.

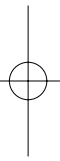

The 1stMainboard comes with a versatile range of I/O features such as 2 serial ports, 1 parallel port, 1 LAN, 2 optional IEEE 1394, 1 PS/2 mouse and keyboard connector, 8 USB ports, 1 media connector (front audio, Line-in, Line-out and Mic-in). In addition, the board is equipped with 2 dual channel enhanced PCI bus master IDE connectors. Ample expansion is available through 1 AGP (8X) and 3 PCI (spec. 2.3) slots to meet the requirement for enjoying the P4 CPU benefits in internet applications, video/3D graphics performance, and so forth.

Other key features are Remote On/Off, Auto Power Failure Recovery, integrated temperature monitoring and system fan control. Included also is 1st Utilities CD with enhanced drivers and a few bundled software solutions.

Package Checklist

If you discover any item below was damaged or lost, please contact your vendor.



Mainboard



**Floppy Drive
Cable**



**80-Pin IDE
Ribbon Cable**



USB Cable



**SATA Power Cable (top)
SATA Data Cable (bottom)
(optional)**



Manual



Drivers



**1394 Bracket
with Cable
(optional)**



I/O Shielding



NOTE: Ist Utilities CD that contains patch files, onboard video/audio chip drivers, related online help and other useful information can be found in your mainboard package.

Please install it right after your Windows operating system installation is done. Place your Ist Utility in the drive, an operating menu will appear in your monitor. Please select *Auto Installation*. It will automatically detect which software tools (patch files, drivers) that the mainboard needs. Press **OK** button to go through the whole installation procedure in a very straight forward and easy way. It also provides you with a custom way to select wanted patch files and software drivers that for onboard chips use. **The top menu of Ist Utilities lists all the functions that allowed by this board.**

The P4M-800T Mainboard

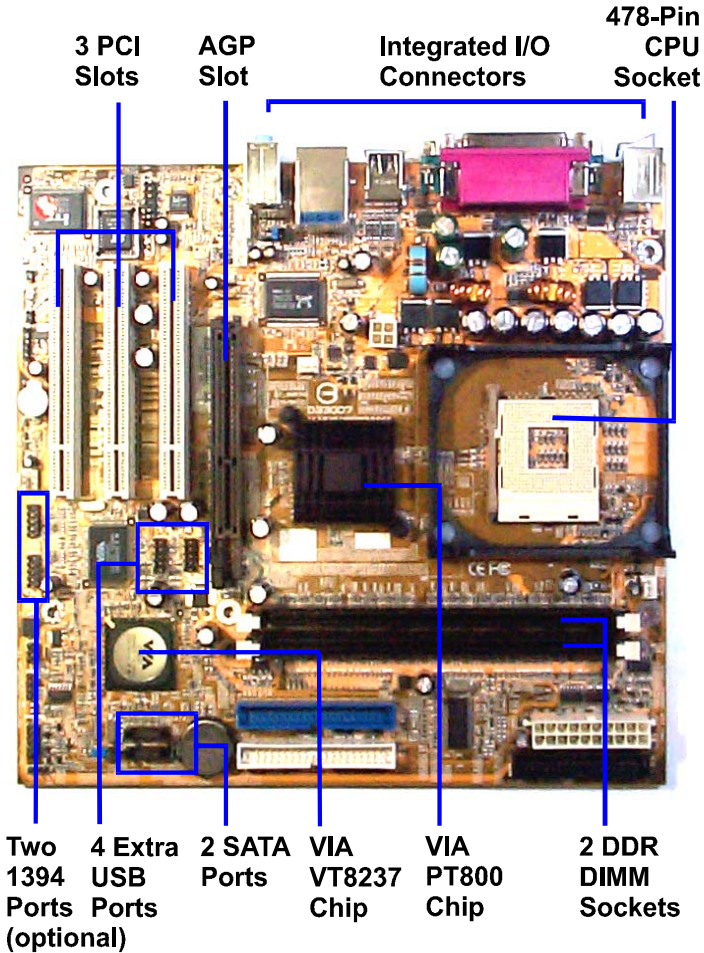

Main Features

- **CPU**
 - Celeron - 2.0 to 2.6 GHz and up* (FSB 400)
 - Pentium 4 -
 - 2.26 to 3.06 GHz and up* (FSB 533)
 - 2.4 to 3.2 GHz and up* (FSB 800)
 - (*: not tested yet)

- **Chipset**
 - North Bridge: *VIA® PT800*
 - South Bridge: *VIA® VT8237*

- **Memory**
 - 2 memory sockets :
 - support 184-pin DDR 266/333/400 MHz
 - memory size totally upto 2 GBs

- **Expansion Slots**
 - 1 AGP Slot : support 2.0 4X/8X (0.8 - 1.5V);
 - 3 PCI Slots

- **IDE Connections**
 - 2 IDE connectors - PIO mode, Ultra DMA 66/100/133
 - up to 4 devices

- **SATA Connections**
 - 2 ports controlled by embedded VT8237® SATA function

- **Audio Features**
 - ALC655
 - AC97 2.2 compliant
 - LINE_IN, LINE_OUT, MICROPHONE_IN Jack
 - Front audio pinheaders

■ **I/O Ports**

2 IDE connectors -
PIO, Bus Master, Ultra DMA 66/100/133
up to 4 devices
2 serial port COM1/2
1 parallel port
1 PS/2 mouse and 1 PS/2 keyboard
8 USB 1.1/2.0 ports

■ **LAN**

RTL® 8100C (10/100); GB dual layout 8100S

■ **IEEE 1394 Ports** (*optional*)

VIA® VT6307
2 ports
1 bracket with cable

■ **Mounting Holes**

6 holes

■ **Mainboard Size**

9.0 x 9.6 (unit: inch)

FIC Unique Innovation for Users (NOVUS) - Enhanced Mainboard Features and System Support

■ LogoGenie

A user friendly GUI supporting Windows 95/98/98SE (not Windows 2000/NT/ME/XP), LogoGenie allows you to customize, create or select a Logo which will be displayed when the system is booting.



NOTE:

1. LogoGenie supports Award BIOS only.
2. If you create a Logo file (.bmp) by LogoGenie, the file size must be 640 x 464 x 256 colors.

To enable this utility, please proceed as follows:

1. Insert CD Pro. Select LogoGenie from the Menu and follow the installation instructions.
2. After LogoGenie has been installed, go to Windows Start Box. In Programs Menu, select LogoGenie, then select LogoGenie.
3. Press F1 to read Help file to understand how to use this software if it is new to you.

■ BIOS Guardian

BIOS Guardian effectively acts as a fire-wall against viruses that can attack the BIOS while the system is running and by default is enabled. Please read Page 3-6 for more detail information. **BIOS Guardian must be disabled before reflash BIOS.**

■ Easy Key

Instead of completing the multi-layered BIOS setup process these 3 Easy Key functions provide direct access to Sub-Menu when completing BIOS settings adjustments.

Easy-Keys are as follows:

Ctrl + c: To enter clock settings menu.

Ctrl + p: To load Performance Default settings and restart.

Ctrl + f: To load Fail-Safe Default settings and restart.

Installation Procedures

The mainboard has several user-adjustable jumpers on the board that allow you to configure your system to suit your requirements. This chapter contains information on the various jumper settings on your mainboard.

To set up your computer, you must complete the following steps:

- Step 1 - Set system jumpers
- Step 2 - Install memory modules
- Step 3 - Install the Central Processing Unit (CPU)
- Step 4 - Install expansion cards
- Step 5 - Connect ribbon cables, cabinet wires, and power supply
- Step 6 - Set up BIOS software
- Step 7 - Install supporting software tools



WARNING: Excessive torque may damage the mainboard. When using an electric screwdriver on the mainboard, make sure that the torque is set to the allowable range of 5.0 ~ 8.0kg/cm.

Mainboard components contain very delicate Integrated Circuit (IC) chips. To prevent static electricity from harming any of the sensitive components, you should follow the following precautions whenever working on the computer:

1. Unplug the computer when working on the inside.
2. Hold components by the edges and try not to touch the IC chips, leads, or circuitry.
3. Wear an anti-static wrist strap which fits around the wrist.
4. Place components on a grounded anti-static pad or on the bag that came with the component whenever the components are separated from the system.

1). Set System Jumpers



NOTE: Users are not encouraged to change the jumper/switch settings not listed in this manual. Changing the settings improperly may adversely affect system performance.

Clear CMOS

The CMOS RAM is powered by the onboard button cell battery. To clear the RTC data:

- (1) Turn off your computer;
- (2) open the system case, disconnect the ATX power cable;
- (3) place the jumper cap onto the pinpair 2-3 at least 6 seconds to enable CMOS clearance;
- (4) place the jumper cap onto the pinpair 1-2 to disable the effect of CMOS clearance;
- (5) connect the ATX power cable; close the system case;
- (6) turn on your computer until *CMOS checksum error* appears;
- (7) hold down the *Delete* key when boots;
- (8) enter the BIOS Setup to re-enter user preferences.

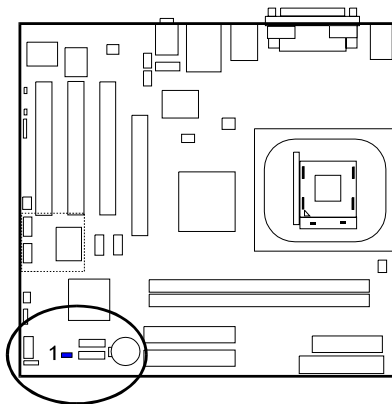

1 2 3 *Disable*
(Default)

1 2 3 *Enable*
(Clear CMOS)

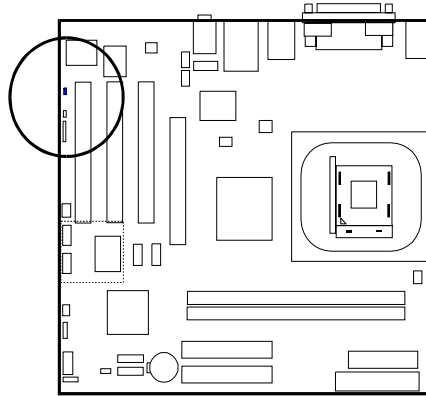

BIOS Anti-Flash Protect

The jumper helps users to prevent the BIOS ROM from being overwritten by mistake.



**Chapter 2
Installation
Procedures**

2). Install Memory Modules

1. Locate DDR DIMM sockets on the mainboard.

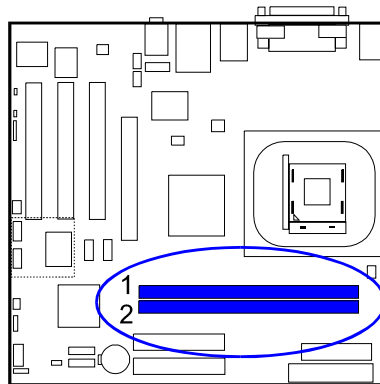
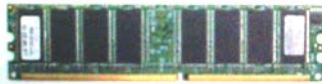

2. Install DDR DIMM straight down into the socket 1 using both hands, then socket 2, and so forth.



3. The clip on both ends of the socket will close up to hold the DDR DIMM in place when the DDR DIMM reaches the socket bottom.

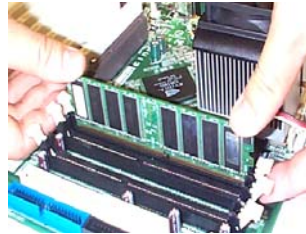

3). Install the CPU

The mainboard has built-in Switching Voltage Regulator to support CPU Vcore autodetection. That is, It has the ability to detect and recognize the CPU voltage, clock, ratio and enables users to set up the CPU frequency from the BIOS Setup Screen. Users can adjust the frequency through *Frequency / Voltage Control* of the BIOS Setup Screen.

The procedures below shows you how to install your CPU and its fan and heatsink. First of all, locate the CPU socket on this mainboard.

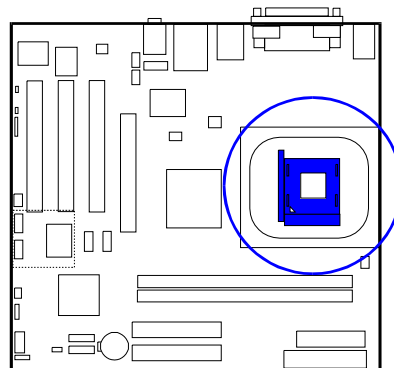

1. Swing the lever upword to 90 degree.

2. Install the CPU and make sure the the pin 1 orientation by aligning the socket corner marking with the socket corner closest to the lever tip. Do not insert the CPU by force. Make sure the processor is fully inserted into the socket on all sides.

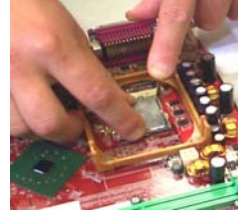

Apply some thermal materials, such as paste or tape, on the CPU top; and install a fan with heatsink that approved by CPU manufacturer to avoid CPU damage. For detail information, please refer to the CPU manufacturer website.



Affix the CPU by pressing the lever downward and locking it beside the socket.

3. Place the fan with heatsink on the CPU top and press down two plastic clips to hook up with the holes on the retention module on two sides.



4. Press down the white bar on each clip to fasten the fan set on the retention module.



Connect ATX Power

The 20-hole power plug (top right) is connected to the ATX power 20-pin pinheaders. The 4-hole 12V power plug (bottom right) is inserted in the ATX_12V power connector.

The plug from the power supply will only insert in one orientation because of the different hole sizes. Find the proper orientation and push down firmly making sure that the pins are aligned.

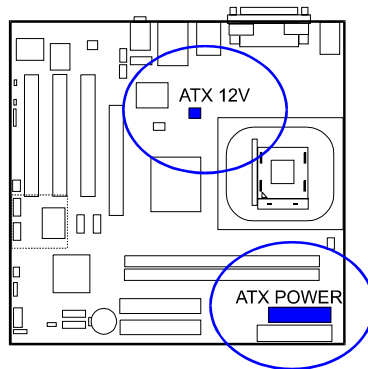
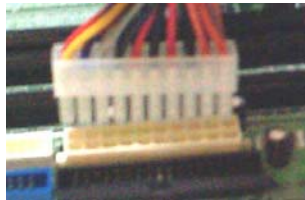

NOTE:

1. Insert the CPU (with fansink and retention module) on socket.
 2. Connect the 4-pin plug of the power supply
 3. Connect the 20-pin plug of the power supply.
- To remove the processor, please do it in reverse order.

4). Install Expansion Cards

This section describes how to connect an expansion card to one of your system expansion slots.

Expansion cards are printed circuit boards that, when connected to the mainboard, increase the capabilities of your system.

For example, expansion cards can provide video and sound capabilities. The mainboard features one AGP and three PCI bus expansion slots.



CAUTION:

1. Make sure to unplug the power supply when adding or removing expansion cards or other system components. Failure to do so may cause severe damage to both the mainboard and expansion cards.
2. Always observe static electricity precautions.
3. Please read Handling Precautions at the start of this manual.

1. Select an available expansion slot.

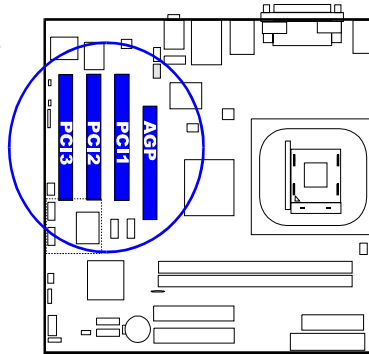

2. Remove the corresponding slot cover from the computer chassis. Unscrew the mounting screw that secures the slot cover and pull the slot cover out from the computer chassis. Keep the slot cover mounting screw nearby.

3. Push the card firmly into the slot. Push down on one end of the expansion card, then the other. Use this rocking motion until the card is firmly seated inside the expansion slot. Secure the card with the screw removed in Step 2.

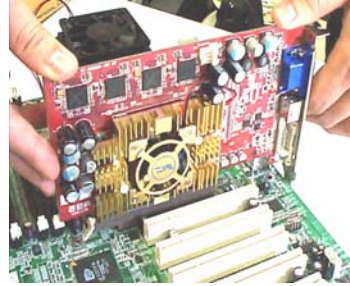

5). Connect Devices

Floppy Diskette Drive Connector

This connector provides the connection with your floppy disk drive.

Insert the floppy ribbon cable (below) onto the floppy connector.



The colored stripe (indicated by the arrow head, right) of the ribbon cable must be the same side with the Pin 1.

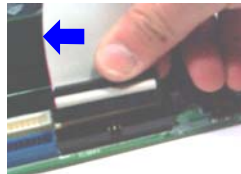
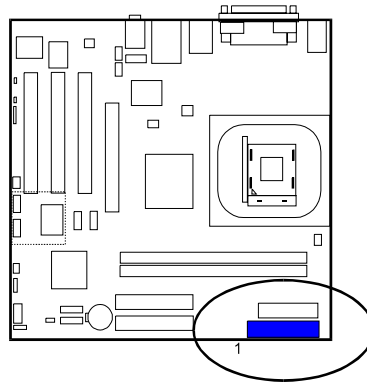

IDE Device Connectors

The two connectors, PRIMARY and SECONDARY, are used for your IDE hard disk drives, CD drives, LS-120 drives, or IDE ZIP drives.

Insert the floppy ribbon cable (below) onto the floppy connector.



The colored stripe (indicated by the arrow head, right) of the ribbon cable must be the same side with the Pin 1.

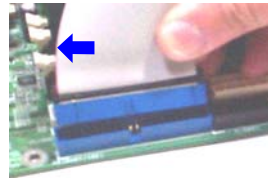
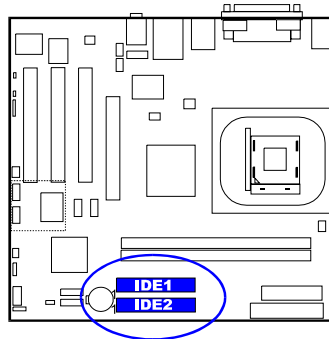

Chapter 2
Installation
Procedures

Fan Connectors

The two connectors, CPU_FAN, SYSTEM_FAN are linked to the CPU fan, case fan, respectively. CHIP_FAN can be used with North Bridge chip fan.

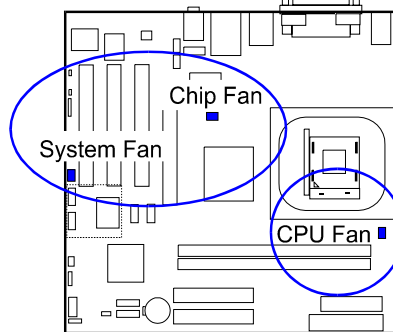
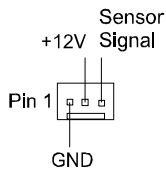

Power Connectors

The 20-pin male block connector is connected to the ATX power supply. The 4-pin male block connector is for the ATX_12V power use. All two connectors are linked with your ATX power supply. The plug from the power supply will only insert in one orientation because of the different hole sizes. Find the proper orientation and push down firmly making sure that the pins are aligned.

Chapter 2
Installation
Procedures

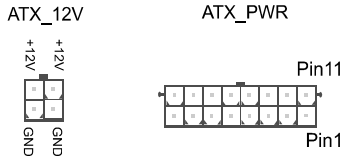

PIN	DEFINITION	PIN	DEFINITION
1	+3.3V	11	+3.3V
2	+3.3V	12	-12V
3	GND	13	GND
4	+5V	14	PS_ON
5	GND	15	GND
6	+5V	16	GND
7	GND	17	GND
8	PWR_GOOD	18	-5V
9	5V_SB	19	+5V
10	+12V	20	+5V

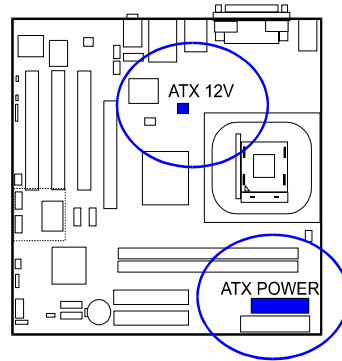

Front Panel Block, Power LED, IR, and Speaker Connector

This block connector includes the connectors for linking with Power LED (3-pin), HDD LED, power button, power/sleep/message waiting button, reset button on the front panel of the system case. Please identify polarities of plug wires for the case speaker and LEDs. Please ask vendor about this information when you buy them and install the system by yourself. The plug wires polarities of these buttons will not affect the function.

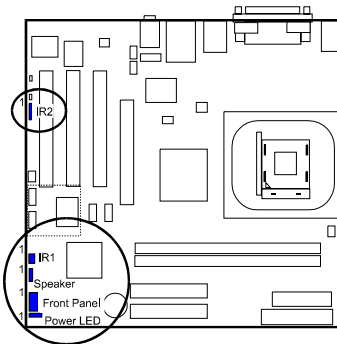

Installation Procedures

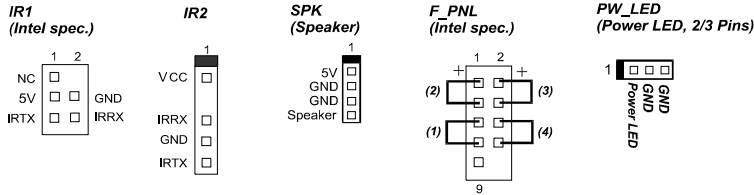

NOTE: Users that want to use IR port must adjust related IR BIOS features described in the next chapter, **Integrated peripherals** section.

(1) **Reset Switch** is connected to the reset button. Push this switch to reboot the system instead of turning the power button off and on.

(2) **HDD LED** is connected to the IDE device indicator. This LED will blink when the hard disk drives are activated.

(3) Power (Single and Dual) /Sleep LED

Please refer to the tables below for the representations of LED states.

There is another 3-Pin Power LED connector on board for some cases that with a 3-pin plug.

Single-Color (2, 3 Pins)

LED	Meaning	State
Off	Off	S4/S5
On	Full On	S0
Flash	Sleep	S1/S3

Dual-Color

LED	Meaning	State
Off	Off	S4/S5
Green	Full On	S0
Other Colors	Sleep	S1/S3

(4) **Power Button** is connected with power button. Push this switch allows the system to be turned on and off rather than using the power supply button.

IR is a pinheader that is used for linking with your ID device to allow transmission of data to another system that also supports the IR feature. This mainboard provides users with two types of IR pinheaders.

Speaker is connected with the case speaker.

CD Audio-In Connectors

The two 1x4 connectors are for CD-ROM drive audio analog input use. The pin assignment are: Pin 1 is Left, Pin2 and 3 are GND, Pin 4 is Right.

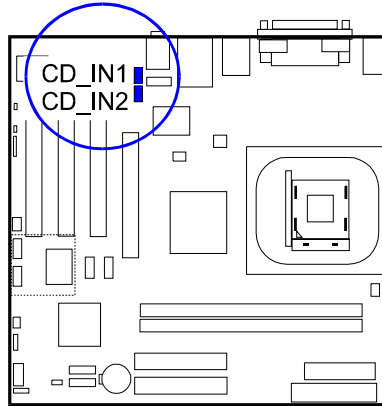

IEEE 1394 Connectors (optional)

The 2 optional 1394 pinheaders on the board provides you with two connections with the peripherals which own 1394 connectors by an optional bracket with cable (see the figure below). The pin definitions of the 1394 pinheaders are listed below also.



PIN	DEFINITION
1	TA1+
2	TA1-
3	GND
4	GND
5	TB1+
6	TB1-
7	VCC
8	VCC
9	NC
10	GND

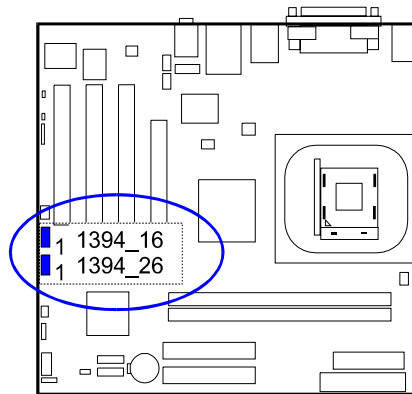

Serial IRQ Connector

This 2-pin connector is used for some system integration use. The pin assignment are: Pin 1 is signal, Pin2 is NC.

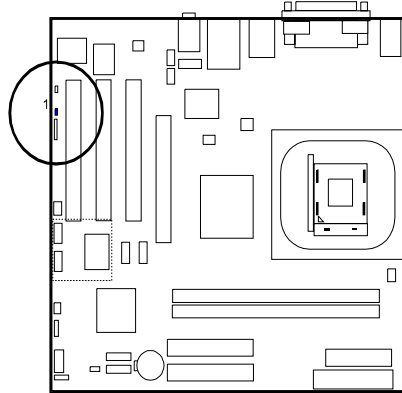

Serial ATA Connectors

The 2 SATA connectors provide you with the connections to serial ATA devices that conform to the Serial ATA specification. Serial ATA supports all ATA and ATAPI devices. The figures below left are two SATA cables (the top one is for power; the next one is for data). The data cable pin assignments of SATA connector.



PIN	DEFINITION
1	GND
2	TXP
3	TXN
4	GND
5	RXN
6	RXP
7	GND

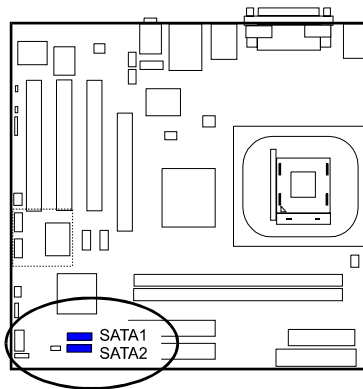

NOTE: Please read BIOS Setup, section of **Integrated Peripherals**, for more information.

PS/2 Keyboard and Mouse Connector

These two 6-pin female (PS/2 keyboard is purple color and PS/2 mouse is green color) connectors are used for your PS/2 keyboard and PS/2 mouse.

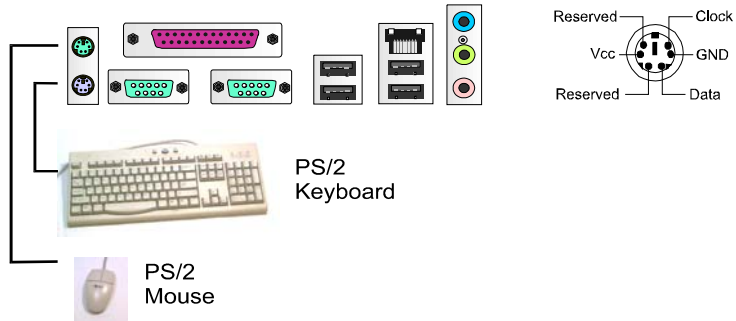

RJ45 LAN Connector

The LAN (RJ45 port) jack is used for the LAN cable plug.

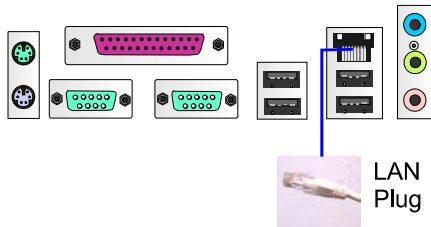

Serial Port Connectors

COM1/2 (9-pin D-sub male connector with teal color) allow you to connect with your devices that use serial ports, such as a serial mouse or an external modem.

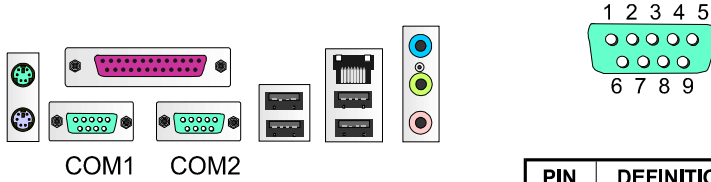

PIN	DEFINITION
1	DCD
2	SIN
3	SOUT
4	DTR
5	GND
6	DSR
7	RTS
8	CTS
9	RI

**Chapter 2
Installation
Procedures**

Printer Connector

This 25-pin D-Sub female burgundy-colored connector is attached to your printer.

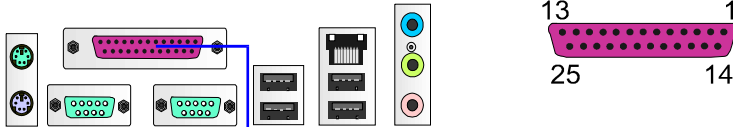

Printer

PIN	DEFINITION
1	STROBE
2 - 9	DATA 0 - 7
10	ACK#
11	BUSY
12	PE
13	SELECT
14	AUTO FEED#
15	ERR#
16	INIT#
17	SLIN#
18-25	GND

Audio I/O Jacks

LINE_OUT (lime) can be connected to headphones or preferably powered speakers. LINE_IN (light blue) allows tape players or other audio sources to be recorded by your computer or played through the LINE_OUT. MIC_IN (pink) allows microphones to be connected for audio input.

Front Audio Connector

The mainboard has a front panel audio F_AUDIO connector (Intel spec.). It allows users to attach the audio device via front panel (instead of rear panel) by a ribbon cable that in some cases. Its pin definitions are resented below.

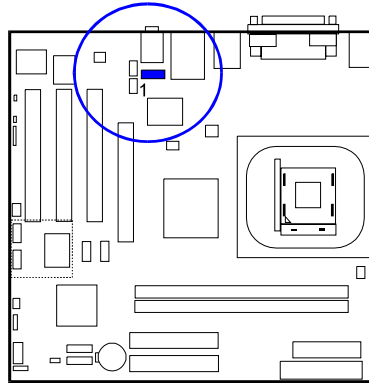
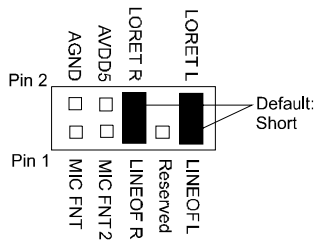

NOTE: If you do not use F_AUDIO, please keep the pinpair 5-6, 9-10 short as default; also, when the front headphone is plugged in, the rear audio output will be disabled.



NOTE: The LINE_IN, LINE_OUT, MICROPHONE jacks can be used the 5.1-channel audio output with its software tool.
For details, please read the FAQ on the web site www.fic.com.tw.

Universal Serial Bus Connectors

The mainboard have 8 USB ports; four USB black jacks that integrated on the edge of the board, the other 4 USB ports on the board. They allows uses to attach with USB devices either from rear or front panels. The USB cable that comes with your mainboard is used to connecting between the USB pinheaders and rear panel. (See the photo below).

**Chapter 2
Installation
Procedures**

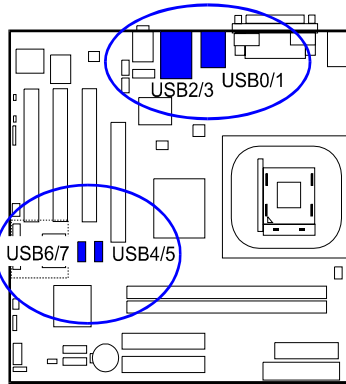
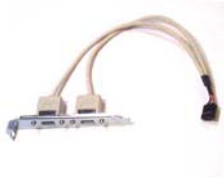
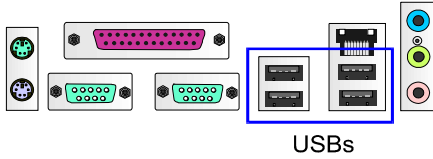

The figure below is pin assignments of the USB4/5. That of USB6/7 is similar.

USB4/5

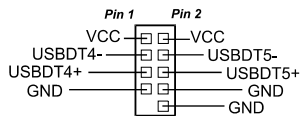

This Page Left Blank for Note

Chapter 2
Installation
Procedures

BIOS Setup

The mainboard comes with the chip that Award BIOS that contains the ROM Setup information of your system. (This chip serves as an interface between the processor and the rest of the mainboard components.) This section explains the information contained in the Setup program and tells you how to modify the settings according to your system configuration.

CMOS Setup Utility



The Setup utility program allows updates to the mainboard configuration settings. The BIOS setup values will be saved in the CMOS. It is executed when the user changes system configuration; user changes system backup battery; or the system detects a configuration error and asks the user to run the Setup program. Use the arrow keys to select and press **Enter** to run the selected program.

Standard CMOS Setup

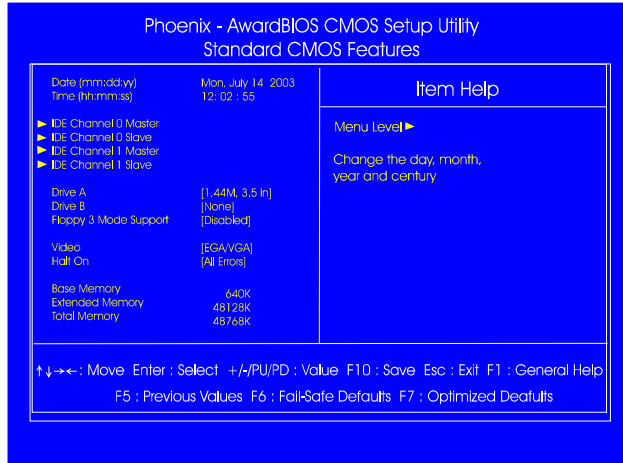

Chapter 3 BIOS Setup

The Standard CMOS Setup screen is displayed above. Each item may have one or more option settings. The system BIOS automatically detects memory size, thus no changes are necessary. Use the arrow keys to highlight the item and then use **PgUp** or **PgDn** keys to select the value you want in each item.

Date

To set the date, highlight the *Date* field and then press **Page Up/Page Down** or **+/-** keys to set the current date. Follow the month, day and year format.

Time

To set the time, highlight the *Time* field and then press **Page Up/Page Down** or **+/-** keys to set the current time. Follow the hour, minute, and second format.

Hard Disks

This field records the specifications for all non-SCSI hard drives installed in the system. The onboard PCI IDE connectors provide Primary and Secondary channels for connecting up to four IDE hard disks or other IDE devices. Each channel can support up to two hard disks, the first of which is the *Master* and the second is the *Slave*.

Hard Disk Configurations

- Capacity:** The hard disk size. The unit is Bytes.
Cylinder: The cylinder number of the hard disk.
Head: The read/write head number of hard disk.
Precomp: The cylinder number at which the disk drive changes the write current.
Landing Zone: The cylinder number that the disk drive heads (read/write) are seated when the disk drive is parked.
Sector: The sector number of each track defined on the hard disk.

Drive A/ Drive B

This field records the types of floppy drives installed in the system. To enter the configuration value for a particular drive, highlight its corresponding field and then select the drive type using the **left-** or **right-arrow** key.

Floppy 3 Mode Support

This is a Japanese standard floppy type drive. The standard stores 1.2MB in a 3.5 inch diskette.

Video

Set this field to the type of video display card installed in the system.

Halt On

This field determines which types of errors will cause the system to halt.

Advanced BIOS Features

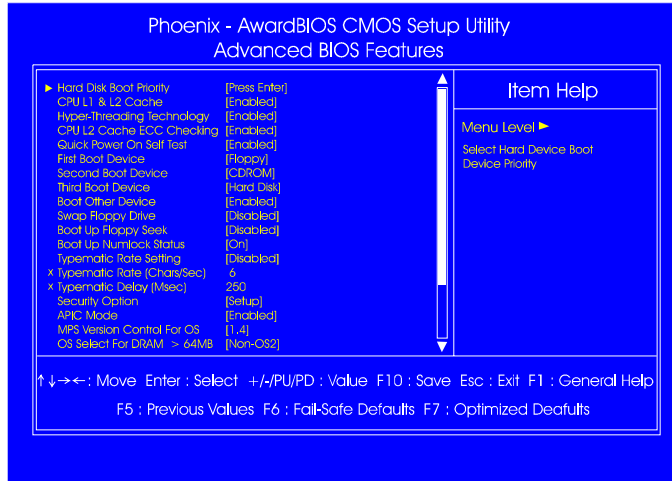

Chapter 3
BIOS Setup

Hard Disk Boot Priority

This feature will auto detect all hard disks of bootable device on the system. It also allows users to select hard disk device booting priority.

CPU L1 & L2 Cache

When enabled, improves the system performance. Disable this item when testing or trouble-shooting. The options are: Enabled, Disabled.

Hyper-Threading Technology

When enabled, it performs as Hyper-Threading tech. does if the CPU support it. The options are: Enabled, Disabled.

Quick Power On Self Test

When enabled, allows the BIOS to bypass the extensive memory test. The options are: Enabled, Disabled.

First/Second/Third Boot Device

This feature allows user to select the boot device priority. The options are: Floppy, LS120, Hard Disk, CDROM, ZIP100, USB-FDD, USB-ZIP, USB-CDROM, USB-HDD, LAN, Disabled.

Boot Other Device

This feature allows user to select the boot device priority.
The options are: Enabled, Disabled.

Swap Floppy Drive

Allows you to switch the order in which the operating system accesses the floppy drives during boot up. Full Screen LOGO Show
It decides whether or not the full screen logo is shown during system booting up. The options are: Enabled, Disabled.

Boot Up Floppy Seek

When enabled, assigns the BIOS to perform floppy diskette drive tests by issuing the time-consuming seek commands.
The options are: Enabled, Disabled.

Boot Up Numlock Status

When set to On, allows the BIOS to automatically enable the Num Lock Function when the system boots up. The options are: On, Off.

Gate A20 Option

When set at Fast, allows a faster access response under Protected mode.
The options are: Fast, Normal.

Typematic Rate Setting

The term typematic means that when a keyboard key is held down, the character is repeatedly entered until the key is released.
The options are: Disabled, Enabled.

Typematic Rate (Chars/Sec)

This feature is available only if the above item, Typematic Rate Setting, is set at Enabled. Sets the rate of a character repeat when the key is held down. The options are: 6, 8, 10, 12, 15, 20, 24, 30.

Typematic Delay (Msec)

This feature is available only if the item, Typematic Rate Setting, is set at Enabled. Sets the delay time before a character is repeated.
The options are: 250, 500, 750, 1000 millisecond.

Security Option

Allows to set the security level of the system. The options: Setup, System.

APIC Mode

Allows you to decide if the system enters the APIC (Advanced Programmable Interrupt Controller) mode or not for more IRQs can be released.

The options are: Enabled, Disabled.

MPS Version Control For OS

When two CPUs onboard (not this board) this feature allows you to select MPS (Multi-Processor Spec.) version control for OS when logo test executes. The options are: 1.1, 1.4.

OS Select For DRAM > 64MB

If your operating system (OS) is OS/2, select the option OS2. Otherwise, stay with the default setting Non-OS2. The options are: Non-OS2, OS2.

HDD S.M.A.R.T. Capability

S.M.A.R.T. stands for Self-Monitoring and Analysis Reporting Technology which allows your hard disk drive to report any read/write errors and issues a warning with LDCM installed. The options: Disabled, Enabled.

Video BIOS Shadow

Enabling this feature will copy the video BIOS to shadow RAM, it will improve the system performance.

The options are: Enabled, Disabled.

BIOS Guardian

It allows the system to prevent computer viruses. Users will need to disable it to update BIOS. The options are: Enabled, Disabled.



NOTE: Please disable this BIOS feature about BIOS Guardian before you start to reflash BIOS.

BIOS Guardian and Reflash BIOS

BIOS Guardian by default is enabled, thus effectively acts as a firewall against viruses that can attack the BIOS while the system is running. It must be disabled before reflash BIOS.

The steps below show you how to off and on BIOS Guardian when reflash BIOS:

1. Press **Del** key while booting. Go to *CMOS Setup Utility* menu.
2. Go to *Advanced BIOS Features* submenu.
3. Set the feature *BIOS Guardian* at Disabled.
4. Save the setting and exit. The system restarts.
5. POST screen holds. A message about BIOS Guardian shows.
6. Press Space bar.
7. Reflash BIOS. Restart the system after complete it.
8. POST screen holds. A message about BIOS Guardian shows.
9. Press **G** key. The feature BIOS Guardian will be enabled again.

Full Screen LOGO Show

It decides whether or not the full screen logo is shown during system booting up. The options are: Enabled, Disabled.

Advanced Chipset Features

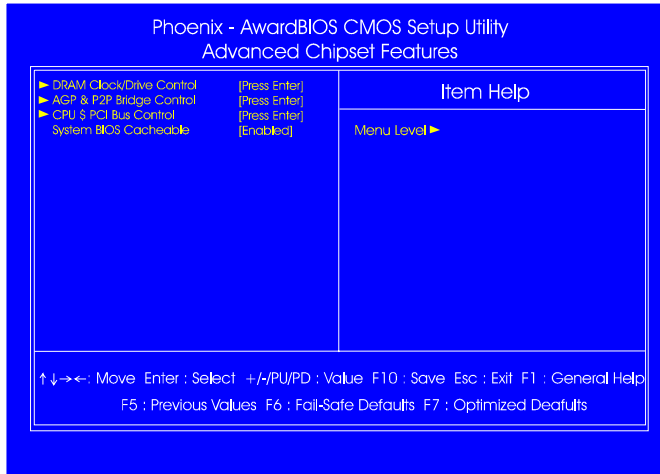

Chapter 3 BIOS Setup

DRAM Clock/Drive Control

Current FSB Frequency, Current DRAM Frequency

This item allows you to get current FSB and DRAM frequencies.

DRAM Clock

The feature allows users to select the DRAM clock.

The options are: 133 MHz, 166 MHz, 200 MHz, By SPD.

DRAM Timing

This feature allows user to select the way to set DRAM timing.

The options are: By SPD, Manual.

DRAM CAS Latency

If the CAS latency of your installed memory module is 2 Cycle, The selection 2 will enhance system performance. The options are: 1.5, 2, 2.5, 3.

Bank Interleave

This item allows users to select the bank interleave function of DRAM, when the feature DRAM Timing By SPD set at Disabled.

The options are: Disabled, 2 Bank, 4 Bank.

Precharge to Active (Trp)

This item allows users to set the clock time from Precharge to Active command. The options are: 2T, 3T, 4T, 5T.

Active to Precharge (Tras)

This item allows users to set the clock time from Active to Precharge command. The options are: 6T, 7T, 8T, 9T.

Active to CMD (Trcd)

This item allows users to set the clock time from Active to Read/Write Delay command. The options are: 2T, 3T, 4T, 5T.

DRAM Command Rate

This item allows users to set Address Time After command.
The options are: 2T Command, 1 T Command.

DRAM Burst Len

This item allows users to set DRAM burst length.
The options are: 4, 8.

Write Recovery Time

This item allows users to set write recovery time.
The options are: 2T, 3T.

AGP & P2P Bridge Control

AGP Aperture Size

It allows you to select the main memory frame size for AGP use.
The options list presents all provided possibilities.

AGP Mode

This feature allows users to select the AGP mode when an AGP add-on card installed. The options are: 4X, 2X, 1X.

AGP Driving Control / AGP Driving Value

These two features allow user to improve the performance of AGP card manually by pressing Page Down/Page UP key if necessary.
The options of AGP Driving Control are: Auto, Manual.

AGP Fast Write

This feature allows you to set AGP fast write mode.
The options are: Disabled, Enabled.

AGP Master 1 WS Write

When enabled, the AGP bus master write access to DRAMs will add one wait-state cycle. The options are: Enabled, Disabled.

AGP Master 1 WS Read

When enabled, the AGP bus master read access to the DRAMs will add one wait-state cycle. The options are: Disabled, Enabled.

AGP 3.0 Calibration cycle

This feature allows users to enable or disable AGP 3.0 calibration cycle.
The options are: Disabled, Enabled.

CPU & PCI Bus Control

PCI Master 0 WS Write

When enabled, allows a zero-wait-state-cycle delay when the PCI master drive writes data to DRAM. The options are: Enabled, Disabled.

PCI Delay Transaction

Enable it to abort the current PCI master cycle and accept a new PCI master request, it reaccepts the original PCI master, returns PCI data phase to the original PCI master. The options are: Disabled, Enabled.

VLink 8X Support

Enables VLink 8X support.
The options are: Enabled, Disabled.

System BIOS Cacheable

When enabled, allows the ROM area F000H-FFFFH to be cacheable when cache controller is activated. The options are: Enabled, Disabled.

Integrated Peripherals

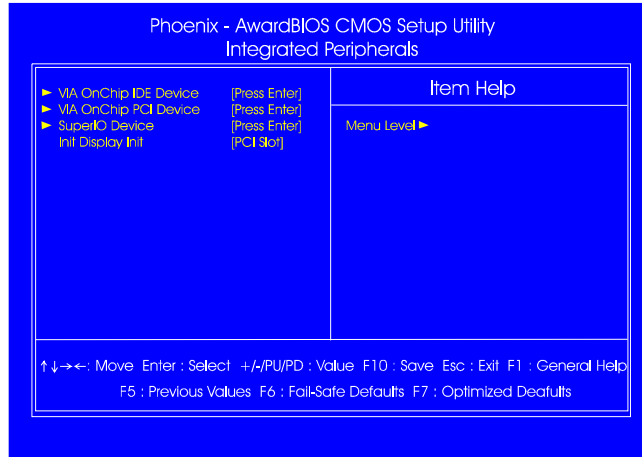

VIA OnChip IDE Device

SATA Mode

This item allows users to select the serial ATA mode
The options are: IDE, Raid.

IDE DMA transfer access

This item allows users to disable the IDE DMA transfer access.
The options are: Enabled, Disabled.

OnChip IDE Channel0/1

When enabled, allows you to use the onboard primary/secondary PCI IDE.
If a hard disk controller card is used, set at Disabled.
The options are: Enabled, Disabled.

IDE Prefetch Mode

When set at Enabled, it allows data to be posted to and prefetched from the primary IDE data ports. Data prefetching is initiated when a data port read occurs. The read prefetch eliminates latency to the IDE data ports and allows them to be performed back to back for the highest possible PIO data transfer rates. The first data port read of a sector is called the demand read. Subsequent data port reads from the sector are called prefetch reads.

The demand read and all prefetch reads must be of the same size (16 or 32 bits). The options are: Enabled, Disabled.

Primary Master/Slave PIO

Allows an automatic or a manual configuration of the PCI primary IDE hard drive (master/slave) mode. The options are: Auto, Mode 0, Mode 1, Mode 2, Mode 3, Mode 4.

Secondary Master/Slave PIO

Allows an automatic or a manual configuration of the PCI secondary IDE hard drive (master/slave) mode. The options are: Auto, Mode 0, Mode 1, Mode 2, Mode 3, Mode 4.

Primary Master/Slave UDMA

Allows an automatic configuration of the PCI primary IDE hard drive (master/slave) mode if Ultra DMA is supported both on the motherboard and the hard disk. The options are: Auto, Disabled.

Secondary Master/Slave UDMA

Allows an automatic configuration of the PCI secondary IDE hard drive (master/slave) mode if Ultra DMA is supported both on the motherboard and the hard disk. The options are: Auto, Disabled.

IDE HDD Block Mode

Block mode is also called block transfer, multiple commands, or multiple sector read/write. If your IDE hard drive supports block mode (most new drives do), select Enabled for automatic detection of the optimal number of block read/writes per sector the drive can support.

The options are: Enabled, Disabled.

VIA OnChip IDE Device

VIA-3058 AC97 Audio

It allows users to disable AC97 audio function in South Bridge.

The options are: Auto, Disabled.

OnChip USB Controller

Disable this option if you are not using the onboard USB 1.1 and USB 2.0 feature. The options are: Disabled, Enabled.

OnChip USB2.0 Controller

Disable this option if you are not using the onboard USB 2.0 feature (USB 1.1 not effected). The options are: Disabled, Enabled.

USB Keyboard Support

Your system contains a Universal Serial Bus (USB) controller and you have a USB keyboard Device. When set at Auto, the BIOS will detect if USB keyboard is installed automatically.
The options are: Auto, Enabled, Disabled.

Onboard 1394 Support

This feature allows you to disable the onboard 1394 feature.
The options are: Enabled, Disabled.

Onboard LAN Support

This feature allows users to enable or disable the onboard LAN support.
The options are: Enabled, Disabled.

Onboard Lan Boot ROM

This feature allows users to enable or disable the onboard Lan boot ROM to boot system. The options are: Enabled, Disabled.

SuperIO Device

Onboard FDC Controller

When enabled, the floppy diskette drive (FDD) controller is activated.
The options are: Enabled, Disabled.

Onboard Serial Port 1/2

If the serial port 1/2 uses the onboard I/O controller, you can modify your serial port parameters. The options are: 3F8/IRQ4, 3E8/IRQ4, 2F8/IRQ3, 2E8/IRQ3, Disabled.

UART Mode Select

Allows you to select the IR modes if the serial port 2 is used as an IR port. Set at Standard, if you use COM2 as the serial port as the serial port, instead as an IR port. The options are: Normal, IrDA, ASKIR, SCR.

UR2 Duplex Mode

Allows you to select the IR modes. The options are: Half, Full.

Onboard Parallel Port

Allows you to select from a given set of parameters if the parallel port uses the onboard I/O controller.

The options are: Disabled, 378/IRQ7, 278/IRQ5, 3BC/IRQ7.

Parallel Port Mode

Allows you to connect with an advanced printer via the port mode it supports. The options are: SPP, EPP, ECP, ECP+EPP.

ECP Mode Use DMA

This feature allows you to select Direct Memory Access (DMA) channel if the ECP mode selected. The options are: 1, 3.

Init Display First

When you install a PCI VGA card on the board, this feature allows you to select the first initiation of the monitor display from PCI or onboard AGP. The options are: PCI Slot, AGP.

Power Management Setup

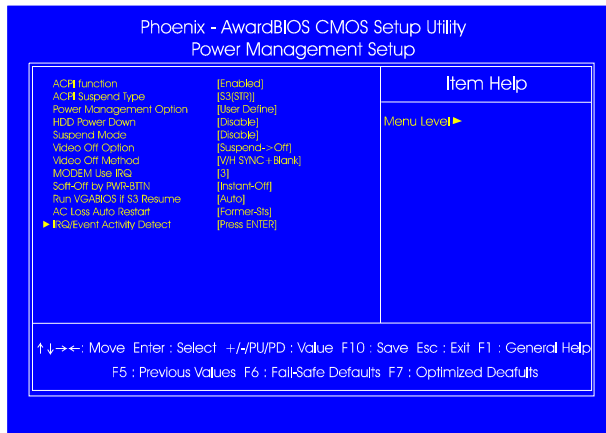

ACPI Function

This item allows you to disable the ACPI function.
The options are: Enabled, Disabled.

ACPI Suspend Type

This item allows you to select suspend mode when the system in ACPI mode. The options are: S1 (POS), S3 (PTR), S1&S3.

Power Management Option

This item allows you to adjust the power management features.
Select User Define for configuring your own power management features. Min Saving initiates all predefined timers in their minimum values. Max Saving, on the other hand, initiates maximum values. The options are: User Define, Min Saving, Max Saving.

HDD Power Down

The option lets the BIOS turn the HDD motor off when system is in Suspend mode. Selecting 1 Min..15 Min allows you define the HDD idle time before the HDD enters the Power Saving Mode.
The options 1 Min..15 Min will not work concurrently. When HDD is in the Power Saving Mode, any access to the HDD will wake the HDD up.
The options are: Disable, 1 Min..15 Min.

Suspend Mode

When disabled, the system will not enter Suspend mode. The specified time option defines the idle time the system takes before it enters Suspend mode. The options are: Disable, 1, 2, 4, 8, 10, 20, 30, 40 Min, 1 Hour.

Video Off Option

This feature provides the selections of the video display power saving mode. The option Suspend - Off allows the video display to go blank if the system enters Suspend mode. The option All Modes - Off allows the video display to go blank if the system enters Doze mode or Suspend mode. The option Always On allows the video display to stay in Standby mode even when the system enters Doze or Suspend mode.
The options are: Suspend - Off, All Modes -> Off, Always On.

Video Off Option

This feature provides the selections of the video display power saving mode. The option Suspend - Off allows the video display to go blank if the system enters Suspend mode. The option All Modes - Off allows the video display to go blank if the system enters Doze mode or Suspend mode. The option Always On allows the video display to stay in Standby mode even when the system enters Doze or Suspend mode.

The options are: Suspend - Off, All Modes -> Off, Always On.

Video Off Method

The option *V/H SYNC+Blank* allows the BIOS to blank off screen display by turning off the V-Sync and H-Sync signals sent from add-on VGA card. *DPMS Support* allows the BIOS to blank off screen display by your add-on VGA card which supports DPMS (Display Power Management Signaling function). *Blank Screen* allows the BIOS to blank off screen display by turning off the red-green-blue signals.

The options are: V/H SYNC+Blank, DPMS Support, Blank Screen.

MODEM Use IRQ

This feature allows you to select the IRQ# to meet your modem IRQ#.

The options are: NA, 3, 4, 5, 7, 9, 10, 11.

Soft-Off by PWRBTN

The selection Delay 4 Sec. will allow the system shut down after 4 seconds after the power button is pressed. The selection Instant-Off will allow the system shut down immediately once the power button is pressed.

The settings are: Delay 4 Sec, Instant-Off.

Run VGABIOS if S3 Resume

This determines whether or not to enable the system to run the VGA BIOS when resuming from S3(STR) or S1&S3. The options are: Auto, Yes, No.

AC Loss Auto Restart

When the system is shut down owing to the power failure, the system will not be back to power on by itself. This feature allows you to set the system back to which power status of the system when the system power is resumed. It always will be back to on if set at On. The system always be back to off if set at Off. The options are Auto, On, Off.

IRQ/Event Activity Detect

PS2KB Wakeup Select

This item allows you to select Hot Key or Password to wake-up the system by PS2 Keyboard. When select Password, please press ENTER key to change password max 8 numbers. The options are : Hot key, Password.

PS2KB Wakeup from S1/S3

It allows you to set a Hot Key to wake-up the system by PS2 Keyboard. The options are: Disable, Ctrl+F1,..., Ctrl+F12, Power, Wake, Any key.
Power and Wake are Windows98 Keyboard button.

PS2MS Wakeup from S1/S3

This item allows you to wake-up the system by PS2 Mouse. The options are: Enabled, Disabled.

USB Resume from S1/S3

This item allows you to wake-up the system by USB device when you save the computer power at S1-S3. The options are: Enabled, Disabled.

PowerOn by PCI Card

When set at Enabled, any PCI-PM event awakes the system from a PCI-PM controlled state. The options are Disabled, Enabled.

Wake Up On LAN/Ring

When set at Enabled, an input signal comes from the other client/server on the LAN/ring awakes the system from a soft off state if connected over LAN/modem. The options are Disabled or Enabled.

RTC Alarm Resume

Enabled allows you to set the time the system will be turned on from the system power-off status. The options are: Enabled, Disabled.

Date (of Month)

This feature allows you to set the day of the alarm starts when the RTC Alarm Resume From Soft Off is set to be Enabled. The options are: 0, 1..31.

Resume Time (hh:mm:ss)

If an ATX power supply is installed and when RTC Alarm Resume is Enabled, this feature allows you to set the time of the alarm starts when the RTC Alarm Resume From Soft Off is set to be Enabled.

The options are: hh (*hour*) - 0, 1, 2,..., 23; mm (*minute*) - 0, 1, 2,...,59; ss (*second*) - 0, 1, 2,...,59.

IRQs Activity Monitoring

Primary INTR

If set at ON, the Primary interrupt (the Primary option in the feature of IRQ# Acitivity) will make the power management wake up the system.

The options are: ON, OFF.

IRQ3../15

After the time period which you set, the system advances from doze mode to suspend mode in which the CPU clock stops and the screen display is off. At this moment, if the IRQ activity occurs, the system goes back to full-on mode directly.

If the IRQ activity which is defined as Non Primary takes place, the system remains off until the corresponding IRQ handler finishes.

The options of IRQ 3, 4, 5, 6, 7, 8, 9, 10, 11, 12, 13, 14, 15 are: Enabled, Disabled.

PnP/PCI Configurations

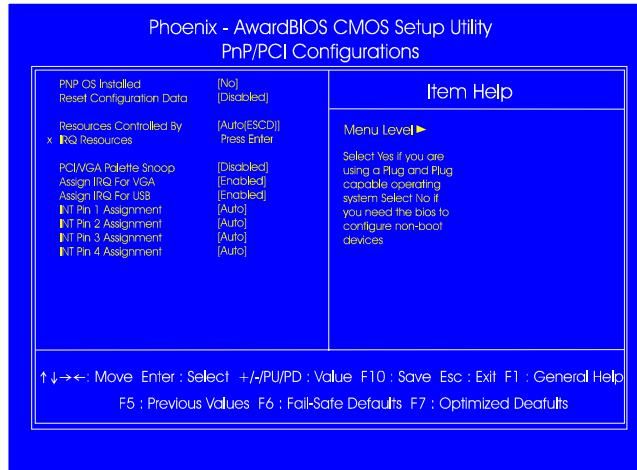

PNP OS Installed

If your operating system is a Plug-and-Play one, such as Windows NT, Windows 95, select Yes. The options are: No, Yes.

Reset Configuration Data

Enabling it to reset the system Extended System Configuration Data (ESCD) when you exit Setup if you have installed a new add-on card and the system reconfiguration has caused such a serious conflict that the operating system can not boot. The options are: Disabled, Enabled.

Resources Controlled By

If set at Auto, the BIOS arranges all system resources. If there exists conflict, select Manual. The options are: Auto (ESCD), Manual.

The manual options of **IRQ- / DMA-** assigned to are: PCI/ISA PnP, Legacy ISA.

PCI/VGA Palette Snoop

Set this feature to be enabled if any ISA adapter card installed in the system requires the VGA palette snoop function.

The options are: Disabled, Enabled.

Assign IRQ For VGA

If your PCI VGA card devices do not need an IRQ, select Disabled; therefore, an IRQ can be released for the system use.

The options are: Enabled, Disabled.

Assign IRQ For USB

If your USB devices do not need an IRQ, select Disabled; therefore, an IRQ can be released for the system use.

The options are: Enabled, Disabled.

INT Pin 1/2/3/4 Assignment

This feature allows you to assign the PCI IRQ numbers for PCI slots. Selecting the default, Auto, allows the PCI controller to automatically allocate the IRQ numbers. The options are: Auto, 3, 4, 5, 7, 9, 10, 11, 12, 14, 15.

PC Health Status

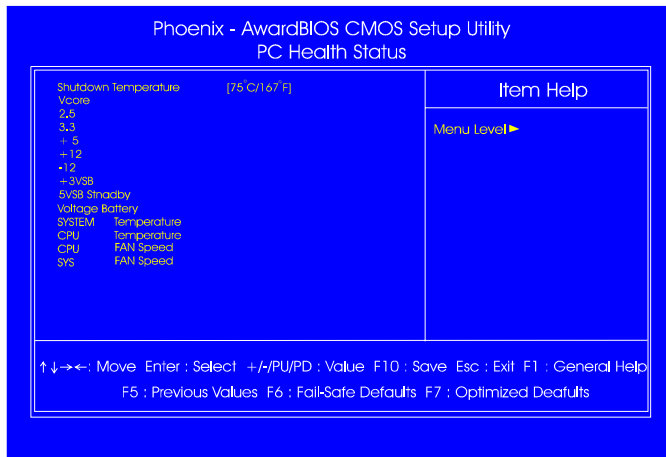

Shutdown Temperature

This feature helps to shutdown the system when the system temperature is as high as the selected temperature to prevent from the overheat problem. The option list presents all the temperatures that supported by the board and Disabled.

Vcore / 2.5V / 3.3V / +5V / +12V / -12V / -3VSB / 5VSB Standby / Voltage Battery / System Temperature / CPU Temperature / CPU FAN Speed / SYS FAN Speed

These items allow end users and technicians to monitor data provided by the BIOS on this mainboard. It is not user-configurable.

Frequency/Voltage Control

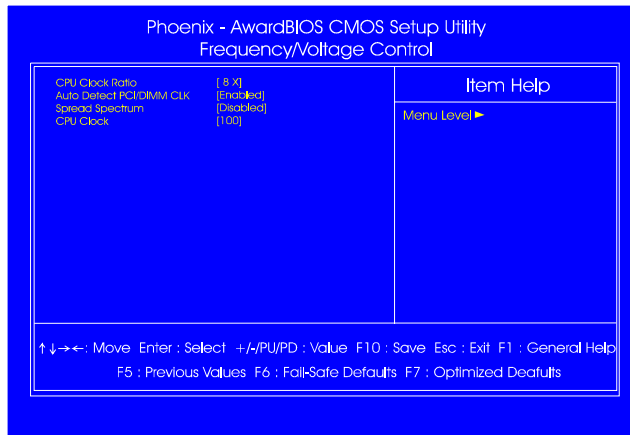

CPU Clock Ratio

This item allows users to set the wanted CPU clock ratio.

Auto Detect DIMM/PCI Clk

When enabled, BIOS will detect the PCI slot and DIMM slot. If no any device in, BIOS will auto disable its clock. The options are: Enabled, Disabled.

Spread Spectrum

This feature allows users to select the range of spread spectrum. The options are: Disabled, +/- 0.35%, +/- 0.50%, +/- 0.75%, +/-1.00 %.

CPU Clock

This feature allows you to set the CPU clock frequency. The default setting is detected on your CPU clock automatically. If you set an inappropriate option which leads to a booting problem, keep pressing the Insert key until the display appears will solve it.

Load Fail-Safe Defaults

This submenu is selected to diagnose the problem after the computer boots, if the computer will not boot. These settings do not give optimal performance.

Load Optimized Defaults

This submenu is selected for default settings which provide the best system performance.

Supervisor/User Password

To enable the Supervisor/User passwords, select the item from the Standard CMOS Setup. You will be prompted to create your own password. Type your password up to eight characters and press Enter. You will be asked to confirm the password. Type the password again and press Enter. To disable password, press Enter twice when you are prompted to enter a password. A message appears, confirming the password is disabled.

Under the BIOS Feature Setup, if *Setup* is selected under the Security Option field and the Supervisor/User Password is enabled, you will be prompted password every time you try to enter the CMOS Setup Utility. If *System* is selected and the Supervisor/User Password is enabled, you will be requested to enter the Password every time when you reboot the system or enter the CMOS Setup utility.

Save and Exit Setup

After you have made changes under Setup, press Esc to return to the main menu. Move cursor to Save and Exit Setup or press F10 and then press Y to change the CMOS Setup. If you did not change anything, press Esc again or move cursor to Exit Without Saving and press Y to retain the Setup settings. The following message will appear at the center of the screen to allow you to save data to CMOS and exit the setup utility: **SAVE to CMOS and EXIT (Y/N)?**

Exit without Saving

If you select this feature, the following message will appear at the center of the screen to allow you to exit the setup utility without saving CMOS modifications:

Quit Without Saving (Y/N)?

This Page Left Blank for Note

Notice

Handling Precautions

Warning:

1. Static electricity may cause damage to the integrated circuits on the motherboard. Before handling any motherboard outside of its protective packaging, ensure that there is no static electric charge in your body.
2. There is a danger of explosion if the battery is incorrectly replaced. Replace only with the same or an equivalent type recommended by the manufacturer.
3. Discard used batteries according to the manufacturer's instructions.
4. Never run the processor without the heatsink properly and firmly attached. PERMANENT DAMAGE WILL RESULT!

Observe the following basic precautions when handling the motherboard or other computer components:

- Wear a static wrist strap which fits around your wrist and is connected to a natural earth ground.
- Touch a grounded or anti-static surface or a metal fixture such as a water pipe.
- Avoid contacting the components on add-on cards, motherboards, and modules with the *golden fingers* connectors plugged into the expansion slot. It is best to handle system components by their mounting brackets.

The above methods prevent static build-up and cause it to be discharged properly.

Trademark

All trademarks mentioned in this manual are registered properly of the respective owners.

Handling Precautions

This manual may not, in whole or in part, be photocopied, reproduced, transcribed, translated, or transmitted in whatever form without the written consent of the manufacturer, except for copies retained by the purchaser for personal archival purposes.
