

SUPER[®]

SUPER P3TDL3
SUPER P3TDLE

USER'S MANUAL

Revision 1.0c

The information in this User's Manual has been carefully reviewed and is believed to be accurate. The vendor assumes no responsibility for any inaccuracies that may be contained in this document, makes no commitment to update or to keep current the information in this manual, or to notify any person or organization of the updates. **Please Note: For the most up-to-date version of this manual, please see our web site at www.supermicro.com.**

SUPERMICRO COMPUTER reserves the right to make changes to the product described in this manual at any time and without notice. This product, including software, if any, and documentation may not, in whole or in part, be copied, photocopied, reproduced, translated or reduced to any medium or machine without prior written consent.

IN NO EVENT WILL SUPERMICRO COMPUTER BE LIABLE FOR DIRECT, INDIRECT, SPECIAL, INCIDENTAL, OR CONSEQUENTIAL DAMAGES ARISING FROM THE USE OR INABILITY TO USE THIS PRODUCT OR DOCUMENTATION, EVEN IF ADVISED OF THE POSSIBILITY OF SUCH DAMAGES. IN PARTICULAR, THE VENDOR SHALL NOT HAVE LIABILITY FOR ANY HARDWARE, SOFTWARE, OR DATA STORED OR USED WITH THE PRODUCT, INCLUDING THE COSTS OF REPAIRING, REPLACING, INTEGRATING, INSTALLING OR RECOVERING SUCH HARDWARE, SOFTWARE, OR DATA.

Any disputes arising between manufacturer and customer shall be governed by the laws of Santa Clara County in the State of California, USA. The State of California, County of Santa Clara shall be the exclusive venue for the resolution of any such disputes. Supermicro's total liability for all claims will not exceed the price paid for the hardware product.

Unless you request and receive written permission from SUPER MICRO COMPUTER, you may not copy any part of this document.

Information in this document is subject to change without notice. Other products and companies referred to herein are trademarks or registered trademarks of their respective companies or mark holders.

Preface

About This Manual

This manual is written for system integrators, PC technicians and knowledgeable PC users. It provides information for the installation and use of the SUPER P3TDL3/P3TDLE motherboard. The SUPER P3TDL3/P3TDLE supports single Intel® Pentium™ III FCPGA 500 MHz-1.4 GHz processors, including low power Pentium™ III processors, at front side bus speeds of 133 and 100 MHz. Please refer to the support section of our web site (<http://www.supermicro.com/TechSupport.htm>) for a complete listing of supported processors. Intel® FCPGA processors are housed in a 370-pin package.

Manual Organization

Chapter 1 includes a checklist of what should be included in your mainboard box, describes the features, specifications and performance of the SUPER P3TDL3/P3TDLE mainboard and provides detailed information about the chipset.

Chapter 2 begins with instructions on handling static-sensitive devices. Read this chapter when you want to install the processor and DIMM memory modules and when mounting the mainboard in the chassis. Also refer to this chapter to connect the floppy and hard disk drives, SCSI drives, the IDE interfaces, the parallel and serial ports and the twisted wires for the power supply, the reset button, the keylock/power LED, the speaker and the keyboard.

If you encounter any problems, read **Chapter 3**, which describes troubleshooting procedures for the video, the memory and the setup configuration stored in CMOS. For quick reference, a general FAQ [Frequently Asked Questions] section is provided. Instructions are also included for contacting technical support. In addition, you can visit our web site at: www.supermicro.com/techsupport.htm for more detailed information.

Chapter 4 includes an introduction to BIOS and provides detailed information on running the CMOS Setup utility.

Appendix A gives information on BIOS error beep codes and messages.

Appendix B provides POST diagnostic error messages.

Table of Contents

Preface

About This Manual	iii
Manual Organization	iii

Chapter 1: Introduction

1-1 Overview	1-1
Checklist	1-1
Contacting Supermicro	1-2
SUPER P3TDL3 Image	1-4
SUPER P3TDLE Image	1-5
SUPER P3TDL3 Layout	1-6
SUPER P3TDL3 Quick Reference	1-7
SUPER P3TDLE Layout	1-8
SUPER P3TDLE Quick Reference	1-9
Server Works LE Chipset: System Block Diagram	1-10
Features of the P3TDL3/P3TDLE Motherboard	1-11
1-2 Chipset Overview	1-12
1-3 Special Features	1-13
BIOS Recovery	1-13
Recovery from AC Power Loss	1-13
1-4 PC Health Monitoring	1-14
1-5 ACPI/PC 98 Features	1-15
1-6 Power Supply	1-17
1-7 Super I/O	1-17

Chapter 2: Installation

2-1 Static-Sensitive Devices	2-1
Precautions	2-1
Unpacking	2-1
2-2 FCPGA Processor Installation	2-2
2-3 Mounting the Motherboard in the Chassis	2-3
2-4 Installing DIMMs	2-4
2-5 Port/Control Panel Connector Locations	2-6
2-6 Connecting Cables	2-7
Power Supply Connector	2-7
Secondary Power Connector	2-7
Power LED	2-8
IDE LED	2-8

PWR_ON	2-8
NIC_LED	2-8
Reset	2-8
Sleep	2-9
Non-Maskable Interrupt	2-9
Extra Universal Serial Bus Connection (USB3)	2-9
5 Volt StandBy	2-9
Fan Fail LED	2-10
Power Fail LED	2-10
NIC LED	2-10
PC	2-10
Chassis Intrusion	2-10
Keyboard Lock	2-11
Overheat LED	2-11
Speaker	2-11
Fan Headers	2-11
Universal Serial Bus Connector	2-11
Wake-On-LAN	2-12
Wake-On-Modem	2-12
Power Supply Fail Header	2-12
SLED1 (SCSI LED) Indicator	2-12
Ethernet Port	2-13
Serial Ports	2-13
ATX PS/2 Keyboard and Mouse Ports	2-13
2-7 DIP Switch Settings	2-14
DIP Switch 1: Core/Bus Ratio	2-14
2-8 Jumper Settings	2-15
CMOS Clear	2-15
SCSI Termination Enable/Disable (P3TDL3 ONLY)	2-15
Overheat Alarm Enable/Disable	2-16
Onboard LAN/NIC Enable/Disable	2-16
3rd Power Supply Failure Alarm Enable/Disable	2-16
Watchdog Reset	2-16
2-9 Parallel Port, Floppy/Hard Disk Drive and SCSI Connections	2-17
Parallel Port Connector	2-17
Floppy Connector	2-18
IDE Connectors	2-18
50-pin Legacy SCSI Connector	2-19
Ultra Wide SCSI Connector	2-19

Ultra160 SCSI Connector	2-20
2-10 Installing Software Drivers	2-21

Chapter 3: Troubleshooting

3-1 Troubleshooting Procedures	3-1
Before Power On	3-1
No Power	3-1
No Video	3-1
Memory Errors	3-2
Losing the System's Setup Configuration	3-2
3-2 Technical Support Procedures	3-2
3-3 Frequently Asked Questions	3-3
3-4 Returning Merchandise for Service	3-5

Chapter 4: BIOS

4-1 Introduction	4-1
4-2 BIOS Features	4-2
4-3 Running Setup	4-2
Main BIOS Setup Menu	4-3
4-4 Advanced BIOS Setup	4-4
4-5 Chipset Setup	4-15
4-6 PCI PnP Setup	4-17
4-7 Power Setup	4-21
4-8 Boot Setup	4-24
4-9 Security Setup	4-26
4-10 Exit Setup	4-28

Appendices:

Appendix A: BIOS Error Beep Codes and Messages	A-1
Appendix B: AMIBIOS Post Checkpoint Codes	B-1

Chapter 1

Introduction

1-1 Overview

Checklist

Congratulations on purchasing your computer motherboard from an acknowledged leader in the industry. Supermicro boards are designed with the utmost attention to detail to provide you with the highest standards in quality and performance.

Please check that the following items have all been included with your motherboard. If anything listed here is damaged or missing, contact your retailer.

One (1) Supermicro Mainboard

One (1) ribbon cable for IDE devices

One (1) floppy ribbon cable for (1) 5.25-inch floppy and (2) 3.5-inch floppy drives

One (1) I/O backpanel shield

SCSI Accessories (depending on motherboard)

One (1) 50-pin Ultra SCSI cable (P3TDL3 ONLY)

One (1) 68-pin LVD SCSI cable (P3TDL3 ONLY)

One (1) set of SCSI driver diskettes (P3TDL3 ONLY)

One (1) SCSI manual (P3TDL3 ONLY)

One (1) Supermicro CD or diskettes containing drivers and utilities

One (1) BIOS User's Manual

Contacting Supermicro

Headquarters

Address: SuperMicro Computer, Inc.
980 Rock Ave.
San Jose, CA 95131 U.S.A.

Tel: +1 (408) 503-8000

Fax: +1 (408) 503-8008

Email: marketing@supermicro.com (General Information)
support@supermicro.com (Technical Support)

Web Site: www.supermicro.com

Europe

Address: SuperMicro Computer B.V.
Het Sterrenbeeld 28, 5215 ML
's-Hertogenbosch, The Netherlands

Tel: +31 (0) 73-6400390

Fax: +31 (0) 73-6416525

Email: sales@supermicro.nl (General Information)
support@supermicro.nl (Technical Support)
rma@supermicro.nl (Customer Support)

Asia-Pacific

Address: SuperMicro, Taiwan
D5, 4F, No. 16 Chien-Ba Road
Chung-Ho 235, Taipei Hsien, Taiwan, R.O.C.

Tel: +886-(2) 8226-3990

Fax: +886-(2) 8226-3991

Web Site: www.supermicro.com.tw

Technical Support:

Email: support@supermicro.com.tw

Tel: 886-2-8226-3990, ext.132 or 139

Notes

SUPER P3TDL3

Figure 1-1. SUPER P3TDL3 Image

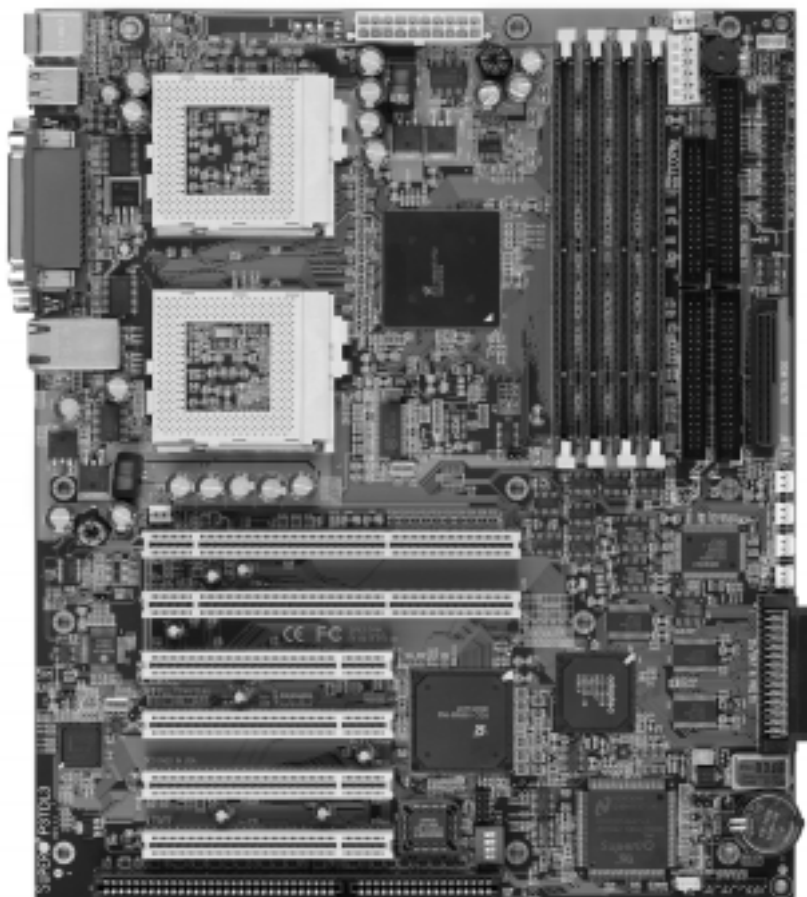

SUPER P3TDLE

Figure 1-2. SUPER P3TDLE

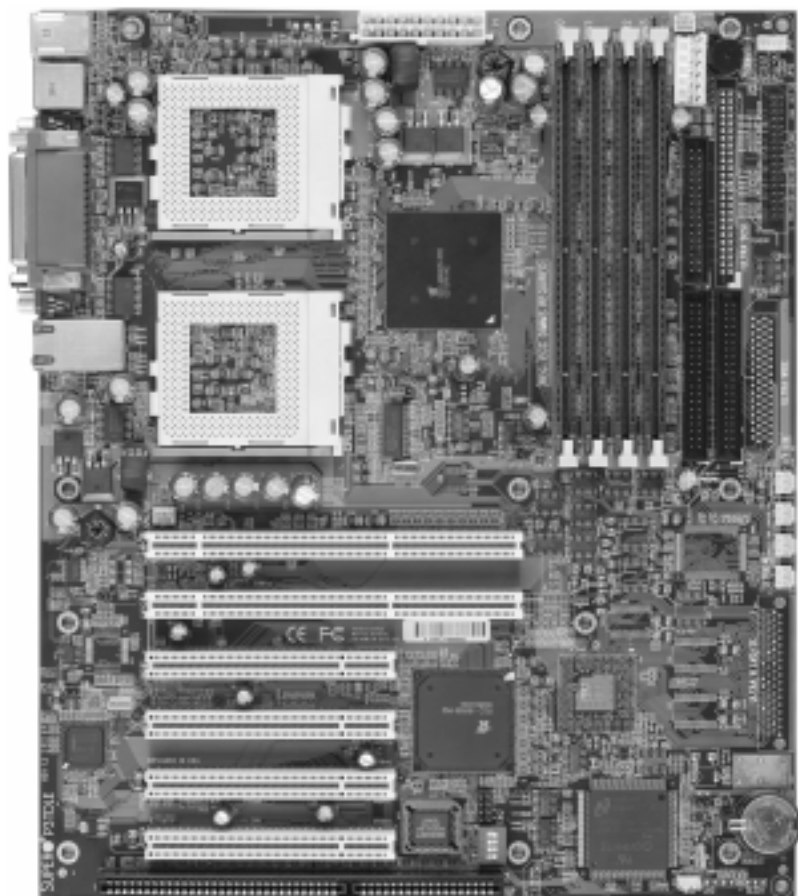
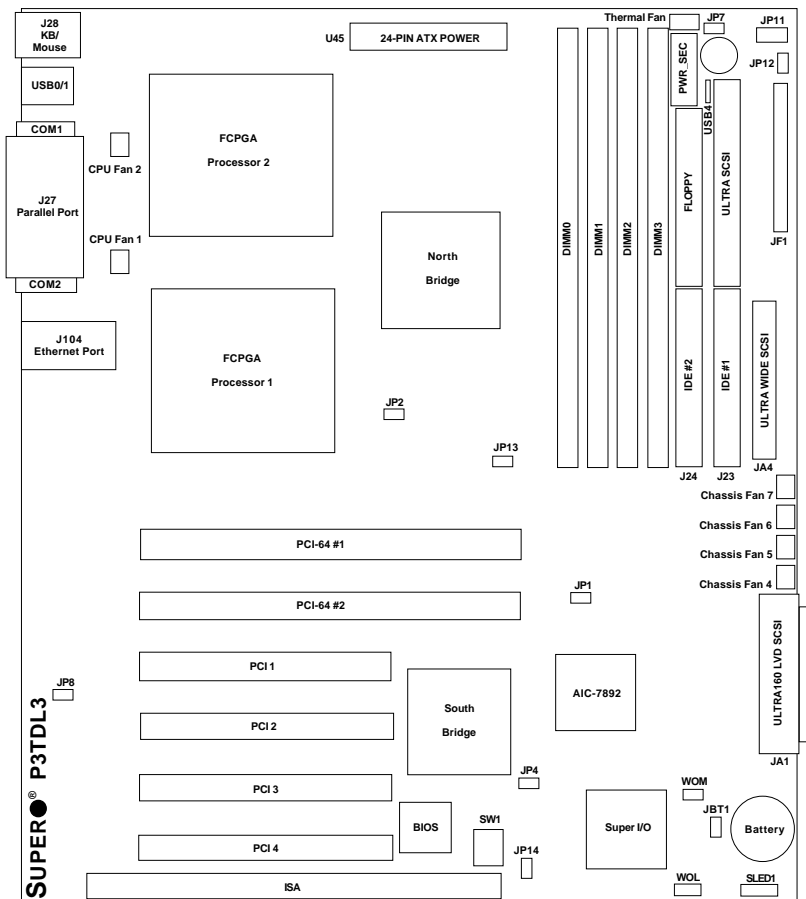

Figure 1-3. SUPER P3TDL3 Layout
(not drawn to scale)



See Chapter 2 for the locations of the I/O ports and for details on the Front Control Panel (JF1) connector.

P3TDL3 Quick Reference

<u>Jumpers</u>	<u>Description</u>	<u>Default Setting</u>
JP1	SCSI Termination	Pins 1-2 (Enabled)
JBT1	CMOS Clear	(See Section 2-8)
JP2	Front Side Bus Speed	Pins 1-2 (Auto)
JP4	Manufacturer's Setting	Open
JP7	Overheat Alarm	Closed (Enabled)
JP8	LAN Enable/Disable	Open (Enabled)
JP12	3rd P/S Failure Alarm	Open (Disabled)
JP13	Speed for 64-bit PCI	Closed (33 MHz)
JP14	Watchdog Reset	Open (Disabled)

<u>DIP Switches</u>	<u>Description</u>	<u>Default Setting</u>
SW1(1-4)	CPU Core/Bus Ratio	(See Section 2-7)

<u>Connectors</u>	<u>Description</u>
Chassis Fan (4 -7)	Chassis Fan Headers
COM1-2	COM1/COM2 Serial Port Connector
CPU FAN (1 & 2)	CPU1/CPU2 Fan Header
DIMM0-DIMM3	Memory (RAM) Slots
J23, J24	IDE Hard Disk Drive Connectors
J26	Floppy Disk Drive Connector
J27	Parallel Printer Port
J28	PS/2 Keyboard/Mouse
J104	Ethernet Port
JA1	Ultra160 LVD SCSI Connector
JA4	Ultra Wide SCSI Connector
JA5	50-pin Ultra SCSI Connector
JF1	Front Control Panel
JP11	Power Supply Fail Header
SLED1	SCSI LED header
Thermal Fan	Thermal Control Fan Header
U38	Universal Serial Bus Ports
U45	ATX Power Connector
USB0/1	USB 1 & 2 Ports
USB4 (J105)	Extra USB Header
WOL	Wake-on-LAN Header
WOM	Wake-on-Modem Header

Figure 1-4. SUPER P3TDLE Layout
(not drawn to scale)

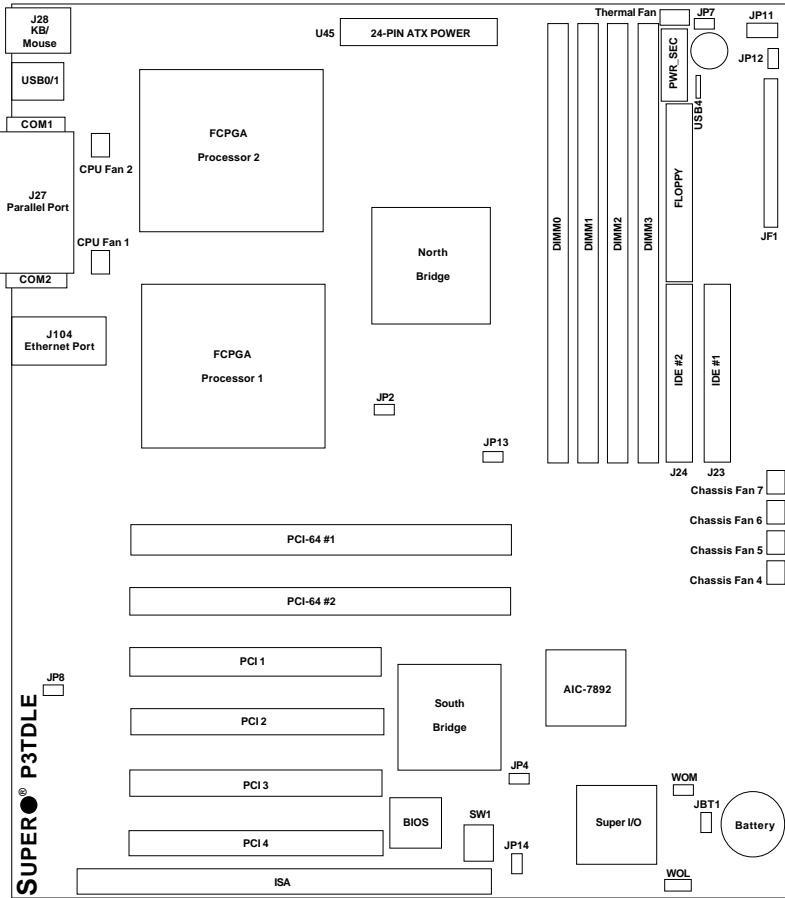

See Chapter 2 for the locations of the I/O ports and for details on the Front Control Panel (JF1) connector.

P3TDLE Quick Reference

<u>Jumpers</u>	<u>Description</u>	<u>Default Setting</u>
JBT1	CMOS Clear	(See Section 2-8)
JP2	Front Side Bus Speed	Pins 1-2 (Auto)
JP4	Manufacturer's Setting	Open
JP7	Overheat Alarm	Closed (Enabled)
JP8	LAN Enable/Disable	Open (Enabled)
JP12	3rd P/S Failure Alarm	Open (Disabled)
JP13	Speed for 64-bit PCI	Closed (33 MHz)
JP14	Watchdog Reset	Open (Disabled)

<u>DIP Switches</u>	<u>Description</u>	<u>Default Setting</u>
SW1(1-4)	CPU Core/Bus Ratio	(See Section 2-7)

<u>Connectors</u>	<u>Description</u>
Chassis Fan (4 -7)	Chassis Fan Headers
COM1-2	COM1/COM2 Serial Port Connector
CPU FAN (1 & 2)	CPU1/CPU2 Fan Header
DIMM0-DIMM3	Memory (RAM) Slots
J23, J24	IDE Hard Disk Drive Connectors
J26	Floppy Disk Drive Connector
J27	Parallel Printer Port
J28	PS/2 Keyboard/Mouse
J104	Ethernet Port
JF1	Front Control Panel
JP11	Power Supply Fail Header
Thermal Fan	Thermal Control Fan Header
U38	Universal Serial Bus Ports
U45	ATX Power Connector
USB0/1	USB 1 & 2 Ports
USB4 (J105)	Extra USB Header
WOL	Wake-on-LAN Header
WOM	Wake-on-Modem Header

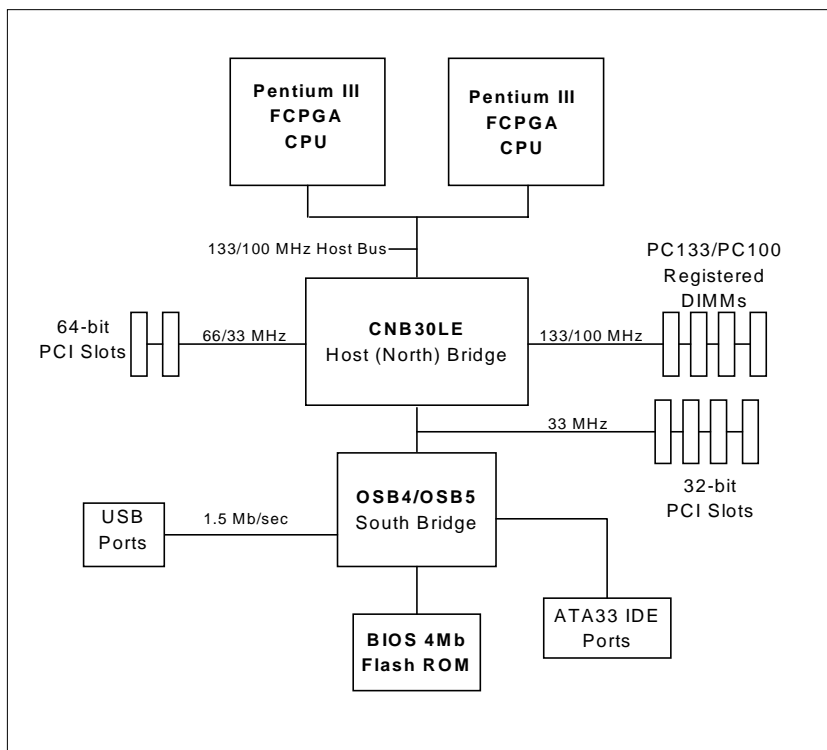

**Figure 1-5. ServerWorks LE Chipset:
System Block Diagram**

Note: This is a general block diagram. See next page for details on actual processor support and PCI slots for your motherboard.

Motherboard Features

Note: SCSI is not supported on the SUPER P3TDLE

CPU

- Single or dual Pentium™ III FCPGA 500 MHz-1.4 GHz processors at a front bus speed of 133/100 MHz.

Note: Please refer to the support section of our web site for a complete listing of supported processors (<http://www.supermicro.com/TechSupport.htm>).

Memory

- Four 168-pin DIMM sockets supporting up to 4 GB registered ECC PC133/100 SDRAM

Note: The memory and front side bus speeds are synchronized. If PC133 memory is used with a 100 MHz FSB, the memory will run at 100 MHz. See page 3-3 for details.

Chipset

- ServerWorks ServerSet III LE (see page 1-13 for details)

Expansion Slots

- Two 64-bit, 66/33 MHz PCI slots
- Four 32-bit, 33 MHz PCI slots
- One ISA slot

BIOS

- 4 Mb AMI® Flash BIOS
- APM 1.2, DMI 2.1, PCI 2.2, ACPI 1.0, Plug and Play (PnP)

PC Health Monitoring

- Seven onboard voltage monitors for CPU core, chipset voltage, +5V and +12V
- Fan status monitor with firmware/software on/off control
- Environmental temperature monitor and control
- CPU fan auto-off in sleep mode
- Power-up mode control for recovery from AC power loss
- System overheat LED and control
- System resource alert

ACPI/PC 98 Features

- Microsoft OnNow
- Slow blinking LED for suspend state indicator
- Main switch override mechanism
- External modem ring-on

Onboard I/O

- AIC-7892 for single channel Ultra160 SCSI (P3TDL3 only)
- 66 MHz SCSI supported (P3TDL3 only)
- Intel 82559 for integrated onboard Ethernet
- 2 EIDE bus master interfaces support Ultra DMA/33
- 1 floppy port interface (up to 2.88 MB)
- 2 Fast UART 16550A compatible serial ports
- 1 EPP (Enhanced Parallel Port) / ECP (Extended Capabilities Port) supported parallel port
- PS/2 mouse and PS/2 keyboard ports
- 4 USB (Universal Serial Bus) ports

Other

- Selectable CPU and chassis fan speed control (set in BIOS)
- Internal/external modem ring-on
- Recovery from AC power loss control
- Wake-on-LAN (WOL)
- Multiple FSB clock frequency selections (set in BIOS)

CD/Diskette Utilities

- BIOS flash upgrade utility
- Device Drivers

Dimensions

- SUPER P3TDL3 - Full ATX: 12" x 10.25" (305 x 260 mm)
- SUPER P3TDLE - Full ATX: 12" x 10.25" (305 x 260 mm)

1-2 Chipset Overview

The ServerWorks ServerSet™ III LE is a high-performance core logic chipset that consists of a North Bridge and a South Bridge.

The North Bridge includes an integrated main memory subsystem and a dual channel PCI bus that bridges the processor bus to a 64-bit PCI bus and a 32-bit PCI bus. The North Bridge also packs and unpacks data for PCI accesses, which reserves more processor bandwidth for multiprocessor motherboards.

The South Bridge provides various integrated functions, including the PCI to ISA bridge and support for UDMA33, security (passwords and system protection), Plug & Play, USBs, power management, interrupt controllers and the SMBus.

The North and South Bridges communicate over a serial bus that uses the PCI clock as a timing reference. This serial bus uses a single pin on both bridges to send a 4-bit word for transmitting commands back and forth.

1-3 Special Features

BIOS Recovery

The BIOS Recovery function allows you to use an image file to recover your BIOS if the BIOS flashing procedure fails (see Section 3-3).

Recovery from AC Power Loss

BIOS provides a setting for you to determine how the system will respond when AC power is lost and then restored to the system. You can choose for the system to remain powered off (in which case you must hit the power switch to turn it back on) or for it to automatically return to a power on state. See the Power Lost Control setting in the BIOS chapter of this manual to change this setting. The default setting is Always OFF.

1-4 PC Health Monitoring

This section describes the PC health monitoring features of the SUPER P3TDL3/P3TDLE. Both have an onboard System Hardware Monitor chip that supports PC health monitoring.

Seven Onboard Voltage Monitors for the CPU Core, Chipset Voltage, +5V and +12V

The onboard voltage monitor will scan these seven voltages continuously. Once a voltage becomes unstable, it will give a warning or send an error message to the screen. Users can adjust the voltage thresholds to define the sensitivity of the voltage monitor.

Fan Status Monitor with Firmware/Software On/Off Control

The PC health monitor can check the RPM status of the cooling fans. The onboard 3-pin CPU and chassis fans are controlled by the power management functions. The thermal fan is controlled by the overheat detection logic.

Environmental Temperature Control

The thermal control sensor monitors the CPU temperature in real time and will turn on the thermal control fan whenever the CPU temperature exceeds a user-defined threshold. The overheat circuitry runs independently from the CPU. It can continue to monitor for overheat conditions even when the CPU is in sleep mode. Once it detects that the CPU temperature is too high, it will automatically turn on the thermal control fan to prevent any overheat damage to the CPU. The onboard chassis thermal circuitry can monitor the overall system temperature and alert users when the chassis temperature is too high.

CPU Fan Auto-Off in Sleep Mode

The CPU fan activates when the power is turned on. It can be turned off when the CPU is in sleep mode. When in sleep mode, the CPU will not run at full power, thereby generating less heat.

CPU Overheat LED and Control

This feature is available when the user enables the CPU overheat warning function in the BIOS. This allows the user to define an overheat temperature. When this temperature is exceeded, both the overheat fan and the warning LED are triggered.

System Resource Alert

This feature is available when used with Intel's LANDesk Client Manager (optional). It is used to notify the user of certain system events. For example, if the system is running low on virtual memory and there is insufficient hard drive space for saving the data, you can be alerted of the potential problem.

Hardware BIOS Virus Protection

The system BIOS is protected by hardware so that no virus can infect the BIOS area. The user can only change the BIOS content through the flash utility provided by SUPERMICRO. This feature can prevent viruses from infecting the BIOS area and destroying valuable data.

Auto-Switching Voltage Regulator for the CPU Core

The auto-switching voltage regulator for the CPU core can support up to 20A current and auto-sense voltage IDs ranging from 1.4V to 3.5V. This will allow the regulator to run cooler and thus make the system more stable.

1-5 ACPI/PC 98 Features

ACPI stands for Advanced Configuration and Power Interface. The ACPI specification defines a flexible and abstract hardware interface that provides a standard way to integrate power management features throughout a PC system, including its hardware, operating system and application software. This enables the system to automatically turn on and off peripherals such as CD-ROMs, network cards, hard disk drives and printers. This also includes consumer devices connected to the PC such as VCRs, TVs, telephones and stereos.

In addition to enabling operating system-directed power management, ACPI provides a generic system event mechanism for Plug and Play and an operating system-independent interface for configuration control. ACPI lever-

ages the Plug and Play BIOS data structures while providing a processor architecture-independent implementation that is compatible with both Windows 98 and 2000.

Note: To utilize ACPI, you must reinstall Windows 98/2000. You can check to see if ACPI has been properly installed by looking for it in the Device Manager, which is located in the Control Panel in Windows.

Microsoft OnNow

The OnNow design initiative is a comprehensive, system-wide approach to system and device power control. OnNow is a term for a PC that is always on but appears to be off and responds immediately to user or other requests.

Slow Blinking LED for Suspend-State Indicator

When the CPU goes into a suspend state, the chassis power LED will start blinking to indicate that the CPU is in suspend mode. When the user presses any key, the CPU will wake-up and the LED will automatically stop blinking and remain on.

Main Switch Override Mechanism

When an ATX power supply is used, the power button can function as a system suspend button. When the user depresses the power button, the system will enter a SoftOff state. The monitor will be suspended and the hard drive will spin down. Depressing the power button again will cause the whole system to wake-up. During the SoftOff state, the ATX power supply provides power to keep the required circuitry in the system alive. In case the system malfunctions and you want to turn off the power, just depress and hold the power button for 4 seconds. The power will turn off and no power will be provided to the motherboard.

External Modem Ring-On

Wake-up events can be triggered by a device such as the external modem ringing when the system is in the SoftOff state. Note that external modem ring-on can only be used with an ATX 2.01 (or above) compliant power supply.

Wake-On-LAN (WOL)

Wake-On-LAN is defined as the ability of a management application to remotely power up a computer that is powered off. Remote PC setup, updates and asset tracking can occur after hours and on weekends so that daily LAN traffic is kept to a minimum and users are not interrupted. The motherboards have a 3-pin header (WOL) to connect to the 3-pin header on a Network Interface Card (NIC) that has WOL capability. Wake-On-LAN must be enabled in BIOS. Note that Wake-On-Lan can only be used with an ATX 2.01 (or above) compliant power supply.

1-6 Power Supply

As with all computer products, a stable power source is necessary for proper and reliable operation. It is even more important for processors that have high CPU clock rates.

The SUPER P3TDL3/P3TDLE accommodates ATX power supplies. Although most power supplies generally meet the specifications required by the CPU, some are inadequate. You should use one that will supply at least 300W of power - an even higher Wattage power supply is recommended for high-load configurations. Also your power supply must provide a +5V standby voltage that supplies at least 720 mA of current.

It is strongly recommended that you use a high quality power supply that meets ATX power supply Specification 2.02 or above. Additionally, in areas where noisy power transmission is present, you may choose to install a line filter to shield the computer from noise. It is recommended that you also install a power surge protector to help avoid problems caused by power surges.

1-7 Super I/O

The disk drive adapter functions of the Super I/O chip include a floppy disk drive controller that is compatible with industry standard 82077/765, a data separator, write pre-compensation circuitry, decode logic, data rate selection, a clock generator, drive interface control logic and interrupt and DMA logic. The wide range of functions integrated onto the Super I/O greatly reduces the number of components required for interfacing with floppy disk drives. The Super I/O supports 360 K, 720 K, 1.2 M, 1.44 M or 2.88 M disk drives and data transfer rates of 250 Kb/s, 500 Kb/s or 1 Mb/s. It also provides two high-speed, 16550 compatible serial communication ports

(UARTs), one of which supports serial infrared communication. Each UART includes a 16-byte send/receive FIFO, a programmable baud rate generator, complete modem control capability and a processor interrupt system.

Each UART includes a 16-byte send/receive FIFO, a programmable baud rate generator, complete modem control capability and a processor interrupt system. Both UARTs provide legacy speed with baud rate of up to 115.2 Kbps as well as an advanced speed with baud rates of 250 K, 500 K, or 1 Mb/s, which support higher speed modems.

The Super I/O supports one PC-compatible printer port (SPP), Bi-directional Printer Port (BPP) , single Enhanced Parallel Port (EPP) / Extended Capabilities Port (ECP).

The Super I/O provides functions that comply with ACPI (Advanced Configuration and Power Interface), which includes support of legacy and ACPI power management through an SMI or SCI function pin. It also features auto power management to reduce power consumption.

The IRQs, DMAs and I/O space resources of the Super I/O can flexibly adjust to meet ISA PnP requirements, which support ACPI and APM (Advanced Power Management).

Chapter 2

Installation

2-1 Static-Sensitive-Devices

Electric-Static-Discharge (ESD) can damage electronic components. To prevent damage to your system board, it is important to handle it very carefully. The following measures are generally sufficient to protect your equipment from ESD.

Precautions

- Use a grounded wrist strap designed to prevent ESD.
- Touch a grounded metal object before removing the board from the anti-static bag.
- Handle the board by its edges only; do not touch its components, peripheral chips, memory modules or gold contacts.
- When handling chips or modules, avoid touching their pins.
- Put the motherboard and peripherals back into their antistatic bags when not in use.
- For grounding purposes, make sure your computer chassis provides excellent conductivity between the power supply, the case, the mounting fasteners and the motherboard.

Unpacking

The motherboard is shipped in antistatic packaging to avoid static damage. When unpacking the board, make sure the person handling it is static protected.

2-2 FCPGA Processor Installation



When handling the processor package, avoid placing direct pressure on the label area of the fan.

The following pages cover the installation procedure. You should install the processor in the motherboard first, then install the motherboard in the chassis, then the memory and add-on cards, and finally the cables and drivers. Following the installation procedures in the order they appear in this chapter should eliminate the most common problems encountered when installing a system.

IMPORTANT: Always connect the power cord last and always remove it before adding, removing or changing any hardware components.

Processor

You are now ready to install the processor. Your motherboard has a 370-pin, FCPGA type socket, which supports single or dual Pentium™ III FCPGA 500 MHz-1.4 GHz processors and low power single or dual Pentium™ III processors at front bus speeds of 133 and 100 MHz. Lift the lever on the FCPGA socket and install with the notched corner of the processor oriented with pin 1. Fully seat the processor into the socket and then close the lever.

Heat Sink

Follow the instructions that came with your processor or heat sink to attach a heat sink to the processor. Your heat sink should have a 3-pin fan, which connects to the CPU FAN header. Make sure that good contact is made between the CPU chip and the heat sink. Insufficient contact will cause the processor to overheat, which may crash the system.

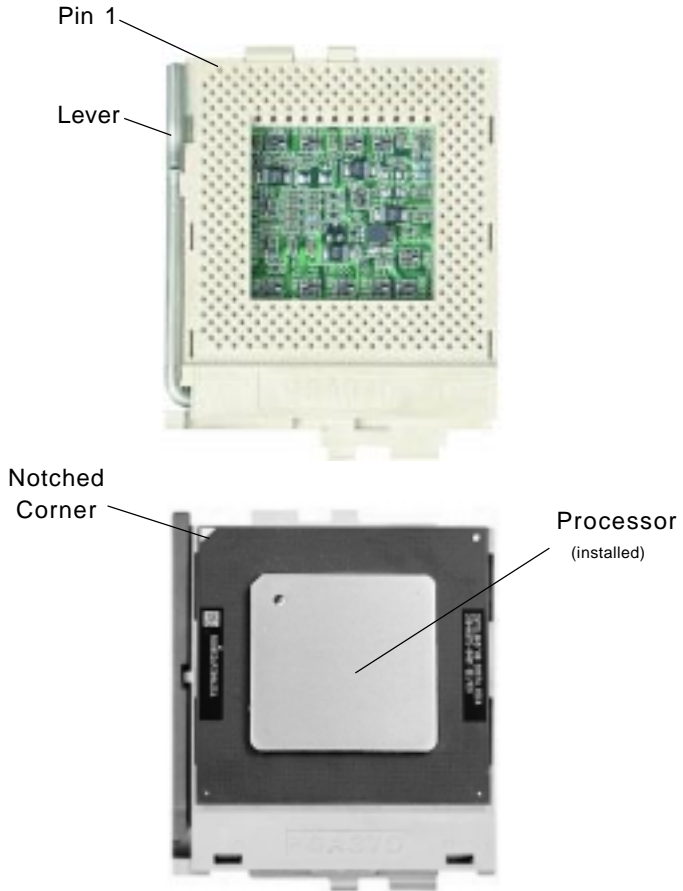

Figure 2-1. FCPGA Socket: Empty and with Processor Installed

2-3 Mounting the Motherboard in the Chassis

All motherboards have standard mounting holes to fit different types of chassis. Chassis may include a variety of mounting fasteners made of metal or plastic. Although a chassis may have both types, metal fasteners are the most highly recommended because they ground the motherboard to the chassis. For this reason, it is best to use as many metal fasteners as possible.

2-4 Installing DIMMs

CAUTION

Exercise extreme care when installing or removing DIMM modules to prevent any possible damage.

NOTE: Check the Supermicro web site for recommended memory modules:

http://www.supermicro.com/TECHSUPPORT/FAQs/Memory_vendors.htm

DIMM Installation (See Figure 2-4)

1. Insert DIMMs as required for the desired system memory.
2. Insert each DIMM module vertically into its slot. Pay attention to the two notches along the bottom of the module to prevent inserting the DIMM module incorrectly.
3. Gently press down on the DIMM module until it snaps into place in the slot.
4. Start DIMM insertion at the DIMM0 slot and continue numerically through the DIMM3 slot, as needed.

Support

The P3TDL3/P3TDLE supports only registered ECC PC100 and PC133 SDRAM. Note that the memory and front side bus speeds are synchronized, meaning if PC133 is used with a 100 MHz FSB, the memory will run at 100 MHz.

Figure 2-4. Side View of DIMM Installation into Slot

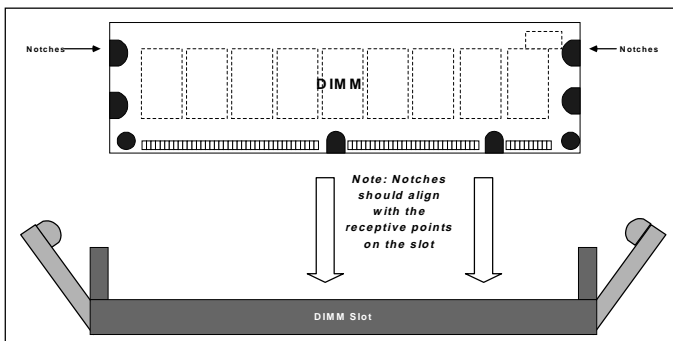

To Install: Insert module vertically and press down until it snaps into place. Pay attention to the two notches.

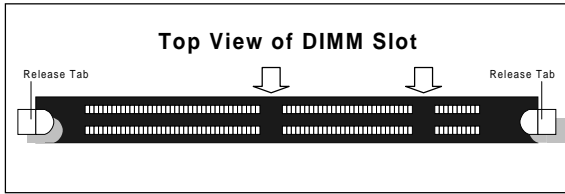
**To Remove:**

Use your thumbs to gently push each release tab outward. This should release the DIMM from the slot.

2-5 Port/Control Panel Connector Locations

The I/O ports are color coded in conformance with the PC 99 specification. See Figure 2-5 below for the colors and locations of the various I/O ports.

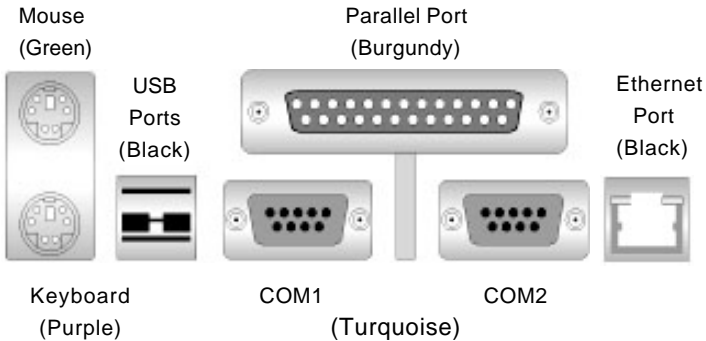

Figure 2-5. I/O Port Locations and Definitions

Front Control Panel

JF1 contains header pins for various front control panel connectors. See Figure 2-6 for the pin locations of the various front control panel buttons and LED indicators. Please note that even and odd numbered pins are on opposite sides. Refer to pages 2-8 to 2-11 for details.

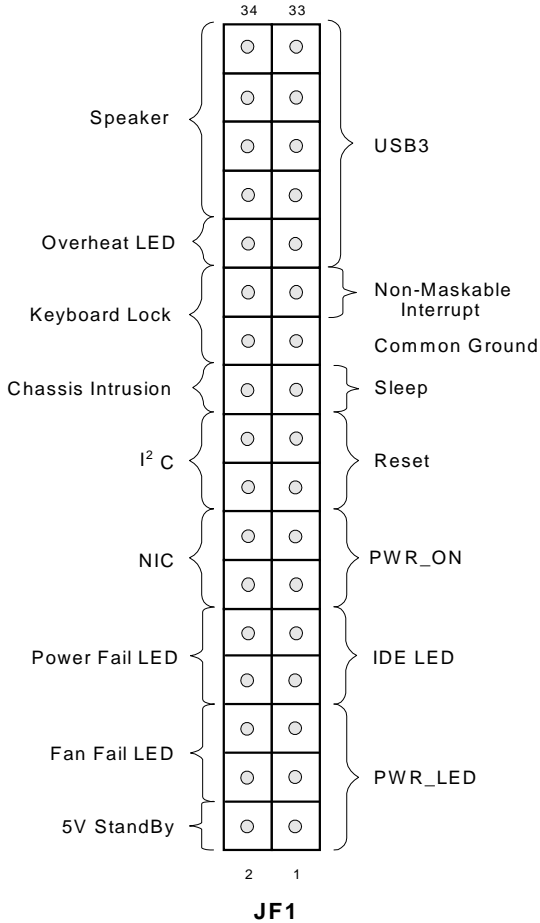
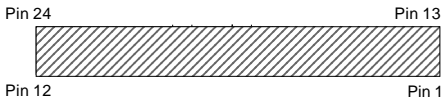

Figure 2-6. Front Control Panel Connectors

2-6 Connecting Cables (see previous page for JF1 connection locations)

Power Supply Connector

The primary power supply connector on the P3TDL3/P3TDLE meets the SSI (Superset ATX) 24-pin specifications; however, it also supports an ATX 20-pin connector. Refer to Table 2-1a for pin definitions. See Figure A below for connector orientation. If a 20-pin connector is used, refer to Figure B for cable placement and to Table 2-1c for standard wiring colors.



(Figure A SSI 24-pin Power Cable)

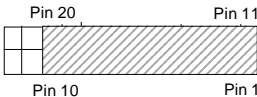

(Figure B SSI 20-pin Power Cable)

Table 2-1a
ATX Power Supply 24-pin Connector
Pin Definitions (ATX POWER)

Pin Number	Definition	Pin Number	Definition
13	+3.3V	1	+3.3V
14	-12V	2	+3.3V
15	COM	3	COM
16	PS_ON#	4	+5V
17	COM	5	COM
18	COM	6	+5V
19	COM	7	COM
20	Res(NC)	8	PWR_OK
21	+5V	9	5VSB
22	+5V	10	+12V
23	+5V	11	+12V
24	COM	12	+3.3V

Table2-1b
ATX Power Supply 20-pin Connector

Pin Number	Definition	Pin #	Definition
11	+3.3V	1	+3.3V
12	-12V	2	+3.3V
13	COM	3	COM
14	PS_ON	4	+5V
15	COM	5	COM
16	COM	6	+5V
17	COM	7	COM
18	-5V	8	PW-OK
19	+5V	9	5VSB
20	+5V	10	+12V

Table 2-1c
Power Supply Wiring Color Definitions

Color	Definition
Orange	+3.3V
Black	Com
Red	5V
White	Power OK
Yellow	+12V
Purple	5V standby
Brown	-5V
(For Reference only)	

Secondary Power Connector

When a 20-pin ATX connector is used, the Secondary Power connector (PWR_SEC) is recommended when a heavy load of peripherals has been added to the motherboard. See Table 2-2 for pin definitions. **Note: Be sure to use a 6-pin connector and check the power supply layout before attaching it.**

Table 2-2
Secondary Power Connector
(PWR_SEC)

Pin Number	Definition
1	Ground
2	Ground
3	Ground
4	+3.3V
5	+3.3V
6	+5V (keyed)

Power LED

The Power LED connection is located on pins 1, 3 and 5 of JF1. See Table 2-3 for pin definitions.

Table 2-3
PWR_LED Pin
Definitions (JF1)

Pin Number	Definition
1	+5V
3	Key
5	GND

IDE LED

The IDE LED connection is located on pins 7 and 9 of JF1. Attach the IDE hard drive LED cable to these pins to display disk activity. See Table 2-4 for pin definitions.

Table 2-4
IDE_LED Pin
Definitions
(JF1)

Pin Number	Definition
7	+5V
9	HD Active

PWR_ON

The PWR_ON connection is located on pins 11 and 13 of JF1. Momentarily contacting both pins will power on/off the system. The user can also configure this button to function as a suspend button. (See the Power Button Mode setting in BIOS.) To turn off the power when set to suspend mode, hold down the power button for at least 4 seconds. See Table 2-5 for pin definitions.

Table 2-5
PWR_ON Connector
Pin Definitions
(JF1)

Pin Number	Definition
11	PW_ON
13	Ground

Reset

The Reset connection is located on pins 15 and 17 of JF1. This connector attaches to the hardware reset switch on the computer case. See Table 2-6 for pin definitions.

Table 2-6
Reset Pin
Definitions
(JF1)

Pin Number	Definition
15	Reset
17	Ground

Sleep

The Sleep connection is located on pins 19 and 21 of JF1. See Table 2-7 for pin definitions.

Table 2-7
Sleep (SLP)
Pin Definitions (JF1)

Pin Number	Definition
19	SLP Input
21	COM GND

Non-Maskable Interrupt

The Non-Maskable Interrupt connection is located on pins 21 and 23 of JF1. See Table 2-8 for pin definitions.

Table 2-8
Non-Maskable Interrupt (NMI)
Pin Definitions (JF1)

Pin Number	Definition
21	COM GND
23	NMI Input

Extra Universal Serial Bus Connection (USB3)

An additional connection for USB3 is included on pins 25, 27, 29, 31, and 33 of JF1 for front side USB access. See Table 2-9 for pin definitions.

Table 2-9
USB3 Pin
Definitions (JF1)

Pin Number	Definition
25	+5V
27	P0-
29	P0+
31	Ground
33	Key

You will need a USB cable (not included) to use this connection.

5 Volt StandBy

A 5 volt standby connection is provided on pin 2 of JF1. See Table 2-10 for pin definitions. **Note:** An extra chassis intrusion header is provided at JL1.

Table 2-10
5 Volt StandBy (5SB)
Pin Definitions (JF1)

Pin Number	Definition
2	5SB Input

Fan Fail LED

A Fan Fail LED connection is located on pins 4 and 6 of JF1. See Table 2-11 for pin definitions. **Note:**

An extra chassis intrusion header is provided at JL1.

Table 2-11
Fan Fail LED (FFL)
Pin Definitions (JF1)

Pin Number	Definition
4	PWR
6	GND

Power Fail LED

A Power Fail LED connection is located on pins 8 and 10 of JF1. See Table 2-12 for pin definitions.

Note: An extra chassis intrusion header is provided at JL1.

Table 2-12
Power Fail LED (PFL)
Pin Definitions (JF1)

Pin Number	Definition
8	PWR
10	GND

NIC_LED

The Network Interface Controller LED connection is located on pins 12 and 14 of JF1. Attach an NIC LED cable to these pins to display network activity. See Table 2-13 for pin definitions.

Table 2-13
NIC LED
Pin Definitions
(JF1)

Pin Number	Definition
12	PWR
14	GND

I²C

The I²C connection is located on pins 16 and 18 of JF1. See Table 2-14 for pin definitions.

Table 2-14
I²C Pin Definitions
(JF1)

Pin Number	Definition
16	SDA
18	SCL

Chassis Intrusion

A Chassis Intrusion connection is located on pin 20 of JF1. See Table 2-15 for pin definitions. **Note:**

An extra chassis intrusion header is provided at JL1.

Table 2-15
Chassis Intrusion (CI)
Pin Definitions (JF1)

Pin Number	Definition
20	Intrusion Input

Keyboard Lock

The Keyboard Lock connection is located on pins 22 and 24 of JF1. See Table 2-16 for pin definitions.

Table 2-16
Keyboard Lock
(KL) Pin Definitions
(JF1)

Pin Number	Definition
22	+5V
24	GND

Overheat LED (OH)

Connect an LED to the OH connection on pin 26 of JF1 to provide advanced warning of chassis overheating. Refer to Table 2-17 for pin definitions.

Table 2-17
Overheat LED (OH)
Pin Definitions (JF1)

Pin Number	Definition
26	OH Active

Speaker

The speaker connection is located on pins 28, 30, 32 and 34 of JF1. See Table 2-18 for pin definitions.

Table 2-18
Speaker Connector Pin
Definitions (JF1)

Pin Number	Function	Definition	
28	+	Key	Red wire, Speaker data
30			No connection
32			Key
34			Speaker data

Fan Headers

The thermal control fan header is designated THERMAL FAN on your board. The two CPU and four Chassis fan headers are designated CPU FAN and CH FAN, respectively. Refer to Table 2-19 for pin definitions.

Table 2-19
Fan Header Pin Definitions
(THERMAL, CPU and CHASSIS
FANS)

Pin Number	Definition
1	Ground (black)
2	+12V (red)
3	Tachometer

* Caution: These fan headers are DC power.

Universal Serial Bus (USB)

Two Universal Serial Bus connectors are located beside the keyboard/mouse ports. USB0 is the bottom connector and USB1 is the top connector. See Table 2-20 for pin definitions.

Table 2-20
Universal Serial Bus Pin Definitions
USB0 **USB1**

Pin Number	Definition	Pin Number	Definition
1	+5V	1	+5V
2	P0-	2	P0-
3	P0+	3	P0+
4	Ground	4	Ground
5	N/A	5	Key

Wake-On-LAN

The Wake-On-LAN header is designated as "WOL." Refer to Table 2-21 for pin definitions. You must enable the LAN Wake-Up setting in BIOS to use this feature. You must also have a LAN card with a Wake-on-LAN connector and cable.

Table 2-21
Wake-On-LAN Pin
Definitions (WOL)

Pin Number	Definition
1	+5V Standby
2	Ground
3	Wake-up

Wake-On-Modem

The Wake-On-Modem header is designated as "WOM." This function allows your computer to receive and be "awakened" by an incoming call when in the suspend state. Refer to Table 2-22 for pin definitions. You must also have a modem card and cable to use WOM.

Table 2-22
Wake-On-Modem Pin
Definitions (WOM)

Pin Number	Definition
1	+5V Standby
2	Ground
3	Wake-up

Power Supply Fail Header

Connect a cable from your power supply to the header at JP11 to provide warning of power supply failure. This warning signal is passed through the PWR_LED pin on JF1 to provide indication of a power failure on the chassis. This feature is only available when using Supermicro power supplies. See Table 2-23 for pin definitions.

Table 2-23
Power Supply Fail Header Pin Definitions
(JP11)

Pin Number	Definition
1	P/S 1 Fail Signal
2	P/S 2 Fail Signal
3	P/S 3 Fail Signal
4	Reset (from MB)

SLED1 (SCSI LED) Indicator (P3TDL3 only)

The SLED connector is used to provide an LED indication of SCSI activity. Refer to Table 2-24 for connecting the SCSI LED.

Table 2-24
SLED1 Pin Definitions

Pin Number	Definition
1	Positive
2	Negative
3	Negative
4	Positive

Ethernet Port

An Ethernet port is located beside the COM2 port on the I/O backplane. This port accepts an RJ45 cable.

RJ45 Ethernet Port



Serial Ports

The COM1 and COM2 serial ports are located under the parallel port (see Figure 2-5). See Table 2-25 for pin definitions.

Table 2-25
Serial Port Pin Definitions
(COM1, COM2)

Pin Number	Definition	Pin Number	Definition
1	DCD	6	CTS
2	DSR	7	DTR
3	Serial In	8	RI
4	RTS	9	Ground
5	Serial Out	10	NC

ATX PS/2 Keyboard and PS/2 Mouse Ports

The ATX PS/2 keyboard and the PS/2 mouse are located on J28. See Table 2-26 for pin definitions. The mouse port is located above the keyboard port.) See Figure 2-5.

Table 2-26
PS/2 Keyboard and Mouse Port
Pin Definitions
(J28)

Pin Number	Definition
1	Data
2	NC
3	Ground
4	VCC
5	Clock
6	NC

2-7 DIP Switch Settings

DIP Switch 1: Core/Bus Ratio

Two "DIP" switches labeled SW1 and SW2 are located on the P3TDL3/P3TDLE near the ISA slot. The four slide switches on DIP Switch 1 are used to set the core/bus ratio.

The example on the right will show you which CPU Core/Bus Ratio to use. The general rule is to divide the CPU speed by the bus speed. If you have a 550 MHz CPU, dividing it by a 100 Mhz front side bus will give you a CPU Core/BUS Ratio of 5.5. After determining the CPU Core/Bus Ratio, refer to Table 2-27 for the correct settings of DIP Switch 1.

Note:

Most Intel processors have a fixed core/bus ratio that will overwrite the setting of DIP Switch 1.

Table 2-27
CPU Core/Bus Ratio Selection
(DIP Switch1)

133/100	SW 1 #1	SW 1 #2	SW 1 #3	SW 1 #4
600/450		ON		ON
667/500	ON			ON
733/550				ON
800/600	ON	ON	ON	
866/650		ON	ON	
933/700	ON		ON	
1G/750			ON	
1.06G/800	ON	ON		
1.13G/850	ON		ON	ON
1.20G/900			ON	ON
1.26G/950		ON	ON	ON

CPU Speed vs. Bus Freq.

2-8 Jumper Settings

Explanation of Jumpers

To modify the operation of the motherboard, jumpers can be used to choose between optional settings. Jumpers create shorts between two pins to change the function of the connector. Pin 1 is identified with a square solder pad on the printed circuit board. See the motherboard layout pages for jumper locations.

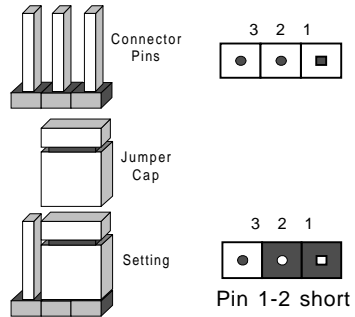

CMOS Clear

JBT1 is not literally a jumper but consists of two contact pads. To clear the contents of CMOS, short these pads together by touching them both with a metal conductor such as the head of a small screwdriver. For ATX power supplies, you must completely shut down the system and remove the AC power cord before clearing CMOS. Do not use the PW_ON connector to clear CMOS.

SCSI Termination Enable/Disable (P3TDL3 only)

Jumper JP1 allows you to enable or disable termination for the SCSI connectors. The normal (default) position is on pins 1-2 to enable SCSI operation. See Table 2-28 for jumper settings.

Table 2-28
SCSI Termination
Enable/Disable
Jumper Settings (JP1)

Jumper Position	Definition
Pins 1-2	Enabled
Pins 2-3	Disabled

Overheat Alarm (Buzzer) Enable/Disable

You may want to disable the audio alarm signal that notifies you of overheat conditions. Jumper JP7 gives you this option. See Table 2-29 for jumper settings.

Table 2-29
Overheat Alarm
Enable/Disable
Jumper Settings (JP7)

Jumper Position	Definition
Open	Disabled
Closed	Enabled

Onboard LAN/NIC Enable/Disable

Change the setting of jumper JP8 to enable or disable the onboard LAN or NIC (Network Interface Card) on your motherboard. See Table 2-30 for jumper settings.

Table 2-30
Onboard LAN/NIC
Enable/Disable
Jumper Settings (JP8)

Jumper Position	Definition
Open	Enabled
Closed	Disabled

3rd Power Supply Failure Alarm

If enabled, the system will notify you in the event of a power supply failure. This feature assumes that three power supply units are installed in the chassis, with one acting as a backup. If you only have one or two power supply units installed, you should disable JP12 to prevent false alarms. See Table 2-31 for jumper settings. (For Supermicro hot-swap triple redundant power supplies only.)

Table 2-31
Power Supply Failure
Alarm Enable/Disable
Jumper Settings (JP12)

Jumper Position	Definition
Open	Disabled
Closed	Enabled

Watchdog Reset

Jumper JP14 allows you to enable or disable the Watchdog feature. The normal (default) position is open to disable the watchdog timer. See Table 2-32 for jumper settings.

Table 2-32
Watchdog
Enable/Disable
Jumper Settings (JP14)

Jumper Position	Definition
Open	Disabled
Closed	Enabled

2-9 Parallel Port, Floppy/Hard Disk Drive and SCSI Connections

Note the following when connecting the floppy and hard disk drive cables:

- The floppy disk drive cable has seven twisted wires.
- A red mark on a wire typically designates the location of pin 1.
- A single floppy disk drive ribbon cable has 34 wires and two connectors to provide for two floppy disk drives. The connector with twisted wires always connects to drive A, and the connector that does not have twisted wires always connects to drive B.

Parallel Port Connector

The parallel port is located on J27.

See Table 2-33 for pin definitions.

Table 2-33
Parallel (Printer) Port Pin Definitions
(J27)

Pin Number	Function	Pin Number	Function
1	Strobe-	2	Auto Feed-
3	Data Bit 0	4	Error-
5	Data Bit 1	6	Init-
7	Data Bit 2	8	SLCT IN-
9	Data Bit 3	10	GND
11	Data Bit 4	12	GND
13	Data Bit 5	14	GND
15	Data Bit 6	16	GND
17	Data Bit 7	18	GND
19	ACK	20	GND
21	BUSY	22	GND
23	PE	24	GND
25	SLCT	26	NC

Floppy Connector

The floppy connector is located on J26. See Table 2-34 for pin definitions.

Table 2-34
Floppy Connector Pin Definitions (JP26)

Pin Number	Function	Pin Number	Function
1	GND	2	FDHDIN
3	GND	4	Reserved
5	Key	6	FDEDIN
7	GND	8	Index-
9	GND	10	Motor Enable
11	GND	12	Drive Select B-
13	GND	14	Drive Select A-
15	GND	16	Motor Enable
17	GND	18	DIR-
19	GND	20	STEP-
21	GND	22	Write Data-
23	GND	24	Write Gate-
25	GND	26	Track 00-
27	GND	28	Write Protect-
29	GND	30	Read Data-
31	GND	32	Side 1 Select-
33	GND	34	Diskette

IDE Connectors

There are no jumpers to configure the onboard IDE connectors J23 and J24. Refer to Table 2-35 for pin definitions.

Table 2-35
IDE Connector Pin Definitions
(J23, J24)

Pin Number	Function	Pin Number	Function
1	Reset IDE	2	GND
3	Host Data 7	4	Host Data 8
5	Host Data 6	6	Host Data 9
7	Host Data 5	8	Host Data 10
9	Host Data 4	10	Host Data 11
11	Host Data 3	12	Host Data 12
13	Host Data 2	14	Host Data 13
15	Host Data 1	16	Host Data 14
17	Host Data 0	18	Host Data 15
19	GND	20	Key
21	DRQ3	22	GND
23	I/O Write-	24	GND
25	I/O Read-	26	GND
27	IOCHRDY	28	BALE
29	DACK3-	30	GND
31	IRQ14	32	IOCS16-
33	Addr 1	34	GND
35	Addr 0	36	Addr 2
37	Chip Select 0	38	Chip Select 1-
39	Activity	40	GND

50-pin Legacy SCSI Connector (P3TDL3 only)

Refer to Table 2-36 for pin definitions for the 50-pin Legacy SCSI connector located at JA5.

Ultra Wide SCSI Connector (P3TDL3 only)

Refer to Table 2-37 for the Ultra Wide SCSI pin definitions. The connector is located at JA4.

Table 2-36
50-pin Legacy SCSI Connector Pin Definitions
(JA5)

Pin Number	Function	Pin Number	Function
1	GND	26	-DB (0)
2	GND	27	-DB (1)
3	GND	28	-DB (2)
4	GND	29	-DB (3)
5	GND	30	-DB (4)
6	GND	31	-DB (5)
7	GND	32	-DB (6)
8	GND	33	-DB (7)
9	GND	34	-DB (P)
10	GND	35	GND
11	GND	36	GND
12	Reserved	37	Reserved
13	Open	38	Termpwr
14	Reserved	39	Reserved
15	GND	40	GND
16	GND	41	-ATN
17	GND	42	GND
18	GND	43	-BSY
19	GND	44	-ACK
20	GND	45	-RST
21	GND	46	-MSG
22	GND	47	-SEL
23	GND	48	-C/D
24	GND	49	-REQ
25	GND	50	-I/O

Table 2-37
Ultra Wide SCSI Connector (JA4)

Pin Number	Function	Pin Number	Function
1	GND	35	-DB (12)
2	GND	36	-DB (13)
3	GND	37	-DB (14)
4	GND	38	-DB (15)
5	GND	39	Parity H
6	GND	40	-DB (0)
7	GND	41	-DB (1)
8	GND	42	-DB (2)
9	GND	43	-DB (3)
10	GND	44	-DB (4)
11	GND	45	-DB (5)
12	GND	46	-DB (6)
13	GND	47	-DB (7)
14	GND	48	Parity L
15	GND	49	GND
16	GND	50	Termpwr
17	Termpwr	51	Termpwr
18	Termpwr	52	Termpwr
19	GND	53	NC
20	GND	54	GND
21	GND	55	-ATTN
22	GND	56	GND
23	GND	57	-BSY
24	GND	58	-ACK
25	GND	59	-RST
26	GND	60	-MSG
27	GND	61	-SEL
28	GND	62	-CD
29	GND	63	-REQ
30	GND	64	-IO
31	GND	65	-DB (8)
32	GND	66	-DB (9)
33	GND	67	-DB (10)
34	GND	68	-DB (11)

Ultra160 SCSI Connector (P3TDL3 only)

Refer to Table 2-38 for pin definitions for the Ultra160 SCSI connector located at JA1.

Table 2-38
68-pin Ultra160 SCSI Connectors (JA1)

Connector Contact Number	Signal Names	Connector Contact Number	Signal Names
1	+DB(12)	35	-DB(12)
2	+DB(13)	36	-DB(13)
3	+DB(14)	37	-DB(14)
4	+DB(15)	38	-DB(15)
5	+DB(P1)	39	-DB(P1)
6	+DB(0)	40	-DB(0)
7	+DB(1)	41	-DB(1)
8	+DB(2)	42	-DB(2)
9	+DB(3)	43	-DB(3)
10	+DB(4)	44	-DB(4)
11	+DB(5)	45	-DB(5)
12	+DB(6)	46	-DB(6)
13	+DB(7)	47	-DB(7)
14	+DB(P)	48	-DB(P)
15	GROUND	49	GROUND
16	DIFFSENS	50	GROUND
17	TERMPWR	51	TERMPWR
18	TERMPWR	52	TERMPWR
19	RESERVED	53	RESERVED
20	GROUND	54	GROUND
21	+ATN	55	-ATN
22	GROUND	56	GROUND
23	+BSY	57	-BSY
24	+ACK	58	-ACK
25	+RST	59	-RST
26	+MSG	60	-MSG
27	+SEL	61	-SEL
28	+C/D	62	-C/D
29	+REQ	63	-REQ
30	+I/O	64	-I/O
31	+DB(8)	65	-DB(8)
32	+DB(9)	66	-DB(9)
33	+DB(10)	67	-DB(10)
34	+DB(11)	68	-DB(11)

2-10 Installing Software Drivers

After the OS (Operating System) has been installed and after installation of any Service Pack or UpGrade to the OS, you must install the software drivers included on the Supermicro CD. The necessary drivers are all included on the Supermicro CD that came packaged with your motherboard. After inserting that CD into your CDROM drive, the display shown in Figure 2-7 should appear. (If the display below does not appear, click on the "My Computer" icon and then on the icon representing your CDROM drive. Finally, double click on the "Setup" icon.)

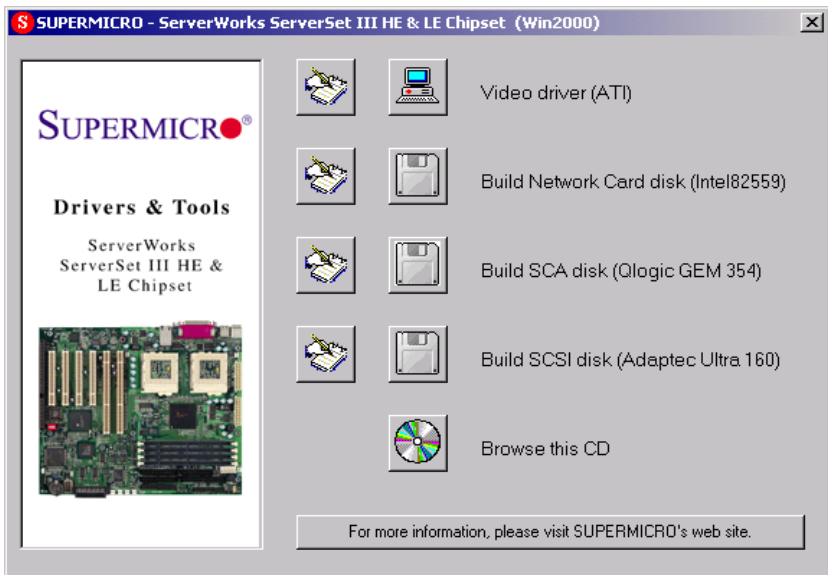

Figure 2-7. Driver/Tool Installation Display Screen

Click the icons showing a hand writing on paper to view the readme files for each item. The bottom icon with a CD on it allows you to view the entire contents of the CD.

Build Network Card disk

Build SCA disk (QLogic GEM 354): for integration with the SuperServer SC850 and SC860 chassis

Build SCSI disk (Ultra160)

Notes

Chapter 3

Troubleshooting

3-1 Troubleshooting Procedures

Use the following procedures to troubleshoot your system. If you have followed all of the procedures below and still need assistance, refer to the 'Technical Support Procedures' and/or 'Returning Merchandise for Service' section(s) in this chapter.

Note: Always disconnect the power cord before adding, changing or installing any hardware components.

Before Power On

1. Make sure no short circuits exist between the motherboard and chassis.
2. Disconnect all ribbon/wire cables from the motherboard, including those for the keyboard and mouse.
3. Remove all add-on cards.
4. Install one CPU (making sure it is fully seated) and connect the chassis speaker and the power LED to the motherboard. (Check all jumper settings as well.)

No Power

1. Make sure no short circuits exist between the motherboard and the chassis.
2. Verify that all jumpers are set to their default positions.
3. Check that the 115V/230V switch on the power supply is properly set.
4. Turn the power switch on and off to test the system.
5. The battery on your motherboard may be old. Check to verify that it still supplies ~3VDC. If it does not, replace it with a new one.

No Video

1. If the power is on but you have no video, remove all the add-on cards and cables.
2. Use the speaker to determine if any beep codes exist. Refer to Appendix A for details on beep codes.

NOTE

If you are a system integrator, VAR or OEM, a POST diagnostics card is recommended. For I/O port 80h codes, refer to App. B.

Memory Errors

1. Make sure the DIMM modules are properly and fully installed.
2. Determine if different speeds of DIMMs have been installed and verify that the BIOS setup is configured for the fastest speed of RAM used. It is recommended to use the same RAM speed for all DIMMs in the system.
3. Make sure you are using PC133 or PC100 compliant, registered ECC SDRAM. EDO and unbuffered SDRAM are not supported.
4. Check for bad DIMM modules or slots by swapping a single module between two slots and noting the results.
5. Make sure all memory modules are fully seated in their slots.
6. Check the power supply voltage 115V/230V switch.

Losing the System's Setup Configuration

1. Check the setting of jumper JBT1. Ensure that you are using a high quality power supply. A poor quality power supply may cause the system to lose the CMOS setup information. Refer to page 1-19 for details on recommended power supplies.
2. The battery on your motherboard may be old. Check to verify that it still supplies ~3VDC. If it does not, replace it with a new one.
3. If the above steps do not fix the Setup Configuration problem, contact your vendor for repairs.

3-2 Technical Support Procedures

Before contacting Technical Support, please take the following steps. Also, note that as a motherboard manufacturer, Super Micro does not sell directly to end-users, so it is best to first check with your distributor or reseller for troubleshooting services. They should know of any possible problem(s) with the specific system configuration that was sold to you.

1. Please go through the "Troubleshooting Procedures" and "Frequently Asked Questions" (FAQ) sections in this chapter or see the FAQs on

our web site < <http://www.supermicro.com/techsupport.htm> > before contacting Technical Support.

2. BIOS upgrades can be downloaded from our web site at <http://www.supermicro.com/techsupport/download.htm>.

Note: Not all BIOS can be flashed depending on the modifications to the boot block code.

3. If you still cannot resolve the problem, include the following information when contacting Super Micro for technical support:

- Motherboard model and PCB revision number
- BIOS release date/version
(this can be seen on the initial display when your system first boots up)
- System configuration

An example of a Technical Support form is on our web site at < http://www.supermicro.com/techsupport/contact_support.htm >.

4. Distributors: For immediate assistance, please have your account number ready when placing a call to our technical support department. We can be reached by e-mail at support@supermicro.com or by fax at (408) 503-8019.

3-3 Frequently Asked Questions

Question: What are the various types of memory that the P3TDL3/P3TDLE motherboard can support?

Answer: The P3TDL3/P3TDLE has four DIMM slots that support 168-pin, registered DIMMs with ECC only. Note that since the motherboard has a 133 MHz memory bus, both PC133 and PC100 memory are fully supported. However, since the memory bus is synchronized to the front side bus speed, you cannot use PC100 with a 133 MHz FSB. Also, using PC133 with a 100 MHz FSB will result in 100 MHz memory speed operation.

Note: Unbuffered SDRAM and non-ECC memory are not supported.

Question: How do I update my BIOS?

Answer: It is recommended that you do not upgrade your BIOS if you are experiencing no problems with your system. Updated BIOS files are located on our web site at < <http://www.supermicro.com> >. Please check our BIOS warning message and the info on how to update your BIOS on our web site. Also, check the current BIOS revision and make sure it is newer

than your BIOS before downloading. Select your motherboard model and download the BIOS file to your computer. Unzip the BIOS update file and you will find the readme.txt (flash instructions), the flash.com (BIOS flash utility) and the BIOS image (xxxxxx.rom) files. Copy these files onto a bootable floppy and reboot your system. It is not necessary to set BIOS boot block protection jumpers on the motherboard. At the DOS prompt, enter the command "flash." This will start the flash utility and give you an opportunity to save your current BIOS image. Flash the boot block and enter the name of the update BIOS image file.

Note: It is important to save your current BIOS and **rename it "super.rom"** in case you need to recover from a failed BIOS update. Select flash boot block, then enter the update BIOS image. Select "Y" to start the BIOS flash procedure and do not disturb your system until the flash utility displays that the procedure is complete. After updating your BIOS, please clear the CMOS then load Optimal Values in the BIOS.

Question: After flashing the BIOS my system does not have video. How can I correct this?

Answer: If the system does not have video after flashing your new BIOS, it indicates that the flashing procedure failed. To remedy this, first clear CMOS per the instructions in this manual and retry the BIOS flashing procedure. If you still do not have video, please use the following **BIOS Recovery Procedure**. First, make sure jumper JPWAKE is set to pins 1-2. Then, turn your system off and place the floppy disk with the saved BIOS image file (see above FAQ) in drive A. Press and hold <CTRL> and <Home> at the same time, then turn on the power with these keys pressed until your floppy drive starts reading. Your screen will remain blank until the BIOS program is done. If the system reboots correctly, then the recovery was successful. The BIOS Recovery Procedure will not update the boot block in your BIOS.

Question: What is on the CD that came with my motherboard?

Answer: The supplied compact disc has quite a few drivers and programs that will greatly enhance your system. We recommend that you review the CD and install the applications you need. Applications on the CD include chipset drivers for Windows and security and audio drivers.

Question: Why can't I turn off the power using the momentary power on/off switch?

Answer: The instant power off function is controlled in BIOS by the "Power Button Mode" setting. When the On/Off feature is enabled, the motherboard

will have instant off capabilities as long as the BIOS has control of the system. When the Standby or Suspend feature is enabled or when the BIOS is not in control such as during memory count (the first screen that appears when the system is turned on), the momentary on/off switch must be held for more than four seconds to shut down the system. This feature is required to implement the ACPI features on the motherboard.

3-4 Returning Merchandise for Service

A receipt or copy of your invoice marked with the date of purchase is required before any warranty service will be rendered. You can obtain service by calling your vendor for a Returned Merchandise Authorization (RMA) number. When returning to the manufacturer, the RMA number should be prominently displayed on the outside of the shipping carton, and mailed prepaid or hand-carried. Shipping and handling charges will be applied for all orders that must be mailed when service is complete.

This warranty only covers normal consumer use and does not cover damages incurred in shipping or from failure due to the alternation, misuse, abuse or improper maintenance of products.

During the warranty period, contact your distributor first for any product problems.

Notes

Chapter 4

BIOS

4-1 Introduction

This chapter describes the AMIBIOS for the P3TDL3/P3TDLE. The AMI ROM BIOS is stored in a Flash EEPROM and can be easily upgraded using a floppy disk-based program.

Note: Due to periodic changes to BIOS, some settings may have been added or deleted and might not yet be recorded in this manual. Refer to the Manual Download area of our web site for any changes to BIOS that are not reflected in this manual.

System BIOS

The BIOS is the Basic Input Output System used in all IBM® PC, XT™, AT®, and PS/2® compatible computers. The BIOS ROM stores the system parameters, such as amount of memory, type of disk drives and video displays, etc. BIOS ROM requires very little power. When the computer is turned off, a back-up battery provides power to the BIOS ROM, enabling it to retain the system parameters. Each time the computer is powered-on, the computer is then configured with the values stored in the BIOS ROM by the system BIOS, which gains control when the computer is powered on.

How To Change the Configuration Data

The configuration data that determines the system parameters may be changed by entering the BIOS Setup utility. This Setup utility can be accessed by pressing at the appropriate time during system boot.

Starting the Setup Utility

Normally, the only visible POST (Power On Self Test) routine is the memory test. As the memory is being tested, press the <Delete> key to enter the main menu of the BIOS Setup utility. From the main menu, you can access the other setup screens, such as the Chipset and Power menus. Section 4-3 gives detailed descriptions of each parameter setting in the Setup utility.

An AMIBIOS identification string is displayed at the left bottom corner of the screen, below the copyright message.

4-2 BIOS Features

- Supports Plug and Play V1.0A and DMI 2.1
- Supports Intel PCI (Peripheral Component Interconnect) (PME) local bus specification
- Supports Advanced Power Management (APM) specification v 1.1
- Supports ACPI
- Supports Flash ROM

AMIBIOS supports the LS120 drive made by Matsushita-Kotobuki Electronics Industries Ltd. The LS120:

- Can be used as a boot device
- Is accessible as the next available floppy drive

AMIBIOS supports PC Health Monitoring chips. When a failure occurs in a monitored activity, AMIBIOS can sound an alarm and display a message. The PC Health Monitoring chips monitor:

- CPU temperature
- Additional temperature sensors
- Chassis intrusion detector
- Five positive voltage inputs
- Two negative voltage inputs
- Three fan speed monitor inputs

4-3 Running Setup

**Optimal default settings are in bold text unless otherwise noted.*

The BIOS setup options described in this section are selected by choosing the appropriate text from the Standard Setup screen. All displayed text is described in this section, although the screen display is often all you need to understand how to set the options (see on next page).

The Main BIOS Setup Menu

Press the <Delete> key during the POST (Power On Self Test) to enter the Main Menu of the BIOS Setup Utility. All Main Setup options are described in this section. The Main BIOS Setup screen is displayed below.

BIOS SETUP UTILITY	
Main	Advanced Chipset PCIPnP Power Boot Security Exit
AMIBIOS Version :	07.00xx
BIOS Build Date :	xxx/xx/xx
BIOS ID :	SSM70626
Processor Type :	PentiumIII™
Processor Speed :	933MHz
System Memory :	256MB
System Time	[10:10:00]
System Date	[Thu 08/24/00]
	↔ Select Screen ↑↓ Select Item +- Change Field Tab Select Field F1 General Help F10 Save and Exit ESC Exit
V02.03 (C)Copyright 1985-2000, American Megatrends, Inc.	

Use the Up/Down arrow keys or the <Tab> key to move between the different settings in the above menu.

When the items "System Time", and "System Date" are highlighted, type in the correct time/date in the time field, and then press "Enter". The date must be entered in MM/DD/YY format. The time is entered in HH:MM:SS format. The time is in also 24-hour format. For example, 5:30 a.m. appears as 05:30:00 and 5:30 p.m. as 17:30:00.

Press the <ESC> key to exit the Main Menu and use the Left/Right arrow keys to enter the the other categories of BIOS settings. The next section is described in detail to illustrate how to navigate through the menus.

***Note: Items displayed in gray are preset and cannot be selected. Items with a blue arrow are commands, not options (i.e. Discard Changes).**

4-4 Advanced BIOS Setup

Choose Advanced BIOS Setup from the AMIBIOS Setup Utility main menu with the Left/Right arrow keys. You should see the following display. Select one of the items in the left frame of the screen, such as SuperIO Configuration, to go to the sub screen for that item. Advanced BIOS Setup options are displayed by highlighting the option using the arrow keys. All Advanced BIOS Setup options are described in this section.

BIOS SETUP UTILITY							
Main	Advanced	Chipset	PCIPnP	Power	Boot	Security	Exit
Setup Warning Setting items on this screen to incorrect values may cause the system to malfunction! > SuperIO Configuration > IDE Configuration > Floppy Configuration > Boot Settings Configuration > Event Log Configuration > Peripheral Device Configuration > System Health Monitor				Configure SuperIO Chipset Winbond627F			
				↔ Select Screen ↑↓ Select Item Enter Go to Sub Scr F1 General Help F10 Save and Exit ES Exit			
V02.03 (C)Copyright 1985-2000, American Megatrends, Inc.							

Use the Up/Down arrow keys to select the "Super I/O Configuration line.

When the "Super IO Configuration" line is highlighted, hit "ENTER" to display its menu.

The following Super IO Configuration screen will appear. Here you can select your options for the your computer's I/O (Input/Output) devices.

Super IO Configuration

BIOS SETUP UTILITY	
Advanced	
Configure Winbond627F Serial Port(s) and Parallel P	
Serial Port1 Address	[3F8]
Serial Port1 IRQ	[4]
Serial Port2 Address	[2F8]
Serial Port2 IRQ	[3]
Serial Port2 Mode	[Normal]
Parallel Port Address	[378]
Parallel Port IRQ	[7]
Parallel Port Mode	[ECP]
ECP Mode DMA Channel	[0]
	↔ Select Screen ↑↓ Select Item +- Change Option F1 General Help F10 Save and Exit ESC Exit
V02.03 (C)Copyright 1985-2000, American Megatrends, Inc.	

The Super IO Configuration includes the following items:

Serial Port 1 Address

This option specifies the base I/O port address of serial port 1. The settings for this item include Disabled, **3F8** and 3E8 and 2E8. Select the desired setting and then press "Enter".

Serial Port 1 IRQ

This option specifies the Interrupt Request address of serial port 1. The settings for this item include Disabled, **4** and 3.

Serial Port 2 Address

This option specifies the base I/O port address of serial port 2. The settings for this item include Disabled, **2F8**, 3E8 and 2E8.

Serial Port 2 IRQ

This option specifies the Interrupt Request address of serial port 2. The settings for this item include Disabled, 4 and **3**.

Serial Port 2 Mode

This option allows the user to set the mode for serial port 2. The settings for this item include **Normal**, Sharp-IR, SIR and Consumer. Normal allows serial port 2 to act normally, while the others set the port up to work with infrared devices.

Parallel Port Address

This option specifies the I/O address used by the parallel port. The settings for this item include Disabled, **378**, 278 and 3BC. Select your setting and then press "Enter".

Parallel Port IRQ

This option allows the user to set the Parallel Port IRQ. The settings for this item include 5 and 7.

Parallel Port Mode

This option specifies the parallel port mode. The settings for this item include Normal, Bi-directional, EPP and **ECP**.

ECP Mode DMA Channel

This option allows the user to set the setting for the ECP Mode of the DMA Channel. The settings for this item include **0**, 1 and 3.

IDE Configuration

Onboard PCI IDE Controller

This option allows the user to enable or disable the integrated IDE Controller. The settings include Disabled, Primary, Second and **Both**. Select "Disabled" to disable the Integrated IDE Controller. Select "Primary" to enable the Primary IDE controller only. Select "Secondary" to enable the Secondary IDE Controller only. Select "Both" to enable both Primary and Secondary IDE Controllers.

Primary IDE Master

When entering "Setup", BIOS automatically detects the presence of IDE devices. This displays the auto detection status of the IDE devices. You can also manually configure the IDE drives by providing the following information:

This option allows the user to configure the IDE devices. When the desired item is highlighted (selected), press "Enter" and the following items will be displayed:

Type

This option sets the type of device that the AMIBIOS attempts to boot from after AMIBIOS POST is completed. The settings include Not installed, **Auto**, CDROM and ARMD. The "Auto" setting allows BIOS to automatically detect the presence of the IDE controller.

LBA/Large Mode

LBA (Logical Block Addressing) is a method of addressing data on a disk drive. In LBA mode, the maximum drive capacity is 137 GB. The settings are Disabled and **Auto**. Select "Disabled" to disable LBA mode. Select "Auto" to enable LBA mode if your device supports it and is not already formatted with the LBA mode.

Block (Multi-Sector Transfer) Mode

This option sets the block mode multi sector transfers option. The settings include Disabled and **Auto**. Disabled: This option prevents the BIOS from using Multi-Sector Transfer on the specified channel. The data to and from the device will occur one sector at a time. Auto: This option allows the BIOS to auto detect device support for Multi-Sector Transfers on the specified channel. If supported, this option allows the BIOS to auto detect the number of sectors per block for transfer from the hard disk drive to memory. The data transfer to and from the device will occur multiple sectors at a time (if the device supports it).

PIO Mode

IDE PIO (Programmable I/O) mode programs timing cycles between the IDE drive and the programmable IDE controller. As the PIO mode increases, the cycle time decreases. The settings are: **Auto**, 1, 2, 3 and 4.

DMA Mode

This item allows the users to select the DMA mode. The settings are: **Auto**, SWDMA0, SWDMA1, SWDMA2, MWDMA0, MWDMA1, MWDMA2, UWDMA0, UWDMA1, UWDMA2, UWDMA3 and UWDMA4. Select Auto to auto detect the DMA Mode. Select SWDMA0 through SWDMA2 to set single word DMA0 through DMA2. Select MWDMA0 through MWDMA2 to set Multi-word DMA0 through DMA2. Select UDMA0 through UDMA4 to set Ultra DMA0 through Ultra DMA4.

S.M.A.R.T.

S.M.A.R.T stands for Self-Monitoring Analysis and Reporting Technology, a feature that can help predict impending drive failures. The settings are **Auto**, Disabled and Enabled. Select "Enabled" or "Disabled" to enable or disable the S.M.A.R.T. Select "Auto" to auto detect S.M.A.R.T.

32Bit Data Transfer

The settings are **Auto**, Disabled and Enabled. Select "Enabled" or "Disabled" to enable or disable the 32-bit Data Transfer function. Select "Auto" to auto detect the 32-bit Data Transfer function.

ARMD Emulation Type

This option is used to select the emulation used when configuring an LS120, MO (Magneto-Optical), or Iomega Zip drive. The settings are **Auto**, Floppy and HardDisk.

Primary IDE Slave

When the system enters "Setup", BIOS automatically detects the presence of IDE devices. This option displays the auto detection status of IDE devices. The settings for "Primary IDE Slave" are the same as those for the "Primary IDE Master".

Secondary IDE Master

This displays the status of auto detection of IDE devices. The settings for "Secondary IDE Master" are the same as those for the "Primary IDE Master".

Secondary IDE Slave

This displays the status of auto detection of IDE devices. The settings for "Secondary IDE Slave" are the same as those for the "Primary IDE Master".

Hard Disk Write Protect

This item allows the user to prevent the hard disk from being overwritten. The options are Enabled or **Disabled**. Enabled allows the drive to be used normally; read, write and erase functions can all be performed. Disabled prevents the hard disk from being erased. This function is effective only when the device is accessed through BIOS.

ATA(PI) Detect Timeout

Set this option to stop the system search for ATAPI devices within the specified number of seconds. The options are 0, 5, 10, 15, 20, 25, 30, and **35** (seconds). Most ATA disk drives can be detected within 5 seconds.

ATA(PI) 80Pin Cable Detection

This option selects the mechanism for detecting the 80-pin ATA(PI) cable. Options include **Host and Device**, Host, and Device. Host: This option uses the motherboard onboard IDE controller to detect the type of IDE cable used. Device: This option uses the IDE disk drive to detect the type of IDE cable used. Host & Device: This option uses both the motherboard onboard IDE controller and IDE disk drive to detect the type of IDE cable used.

Floppy Configuration

Floppy A

Use this option to specify which of floppy drive you have installed in the A drive. The settings are Disabled, 360 KB 5 1/4", 1.2 MB 5 1/4", 720 KB 3 1/2", **1.44 MB 3 1/2"** and 2.88 MB 3 1/2".

Floppy B

Use this option to specify which of floppy drive you have installed in the B drive. The settings are Disabled, 360 KB 5 1/4", 1.2 MB 5 1/4", 720 KB 3 1/2", **1.44 MB 3 1/2"** and 2.88 MB 3 1/2".

Diskette Write Protect

This option allows you to prevent any writing to your floppy diskette. The settings are Enabled and **Disabled**. The Enabled setting is effective only if the device is accessed through BIOS.

Floppy Drive Seek

Use this option to Enable or **Disable** the floppy seek routine on bootup.

Boot Settings Configuration

Quick Boot

This option allows the BIOS to skip certain tests that are normally performed on boot up. You can disable the option to speed up boot time. The settings are **Disabled** and Enabled.

Quiet Boot

If Disabled, this option will cause the normal POST messages to be displayed upon setup. When **Enabled**, the OEM logo is displayed instead of the POST messages.

Add-On ROM Display Mode

Set this option to display add-on ROM (read-only memory) messages. The settings for this option are **Force BIOS** and Keep Current. Force BIOS allows the computer to force a third party BIOS to display during system boot. Keep Current has the system display AMIBIOS information on bootup.

BootUp Num Lock

This option is used to select the status of the Number Lock function on your keyboard on bootup. The settings are **On** and Off.

BootUp CPU Speed

This option is used set the CPU speed to either **High** or Low.

PS/2 Mouse Support

This option specifies whether a PS/2 Mouse will be supported. Settings are **Enabled** and Disabled.

Typematic Rate

Set this option to select the rate at which the computer repeats a key that is held down. Settings are **Fast** and Slow. Fast: This sets the rate the computer repeats a key to over 20 times per second. Under normal operations, this setting should not be changed. Slow: This sets the rate the computer repeats a key to under 8 times per second.

System Keyboard

This option is to let the system know if a keyboard is **Present** or Absent.

Primary Display

This option specifies the type of monitor display you have installed on the system. The settings are Absent, **VGA/EGA**, Color 40 x 25, Color 80 x 25 and monochrome.

Parity Check

Use this option to either Enable or **Disable** the use of memory parity checking.

Boot to OS/2

This option can be used to boot the system to an OS/2 operating system. The settings are **No** and Yes.

Wait for F1 if Error

This settings for this option are **Enabled** and Disabled. Disabled: This prevents the AMIBIOS to wait on an error for user intervention. This setting should be used if there is a known reason for a BIOS error to appear. An example would be a system administrator must remote boot the system. The computer system does not have a keyboard currently attached. If this setting is set, the system will continue to bootup in to the operating system. If 'F1' is enabled, the system will wait until the BIOS setup is entered. Enabled: This option allows the system BIOS to wait for any error. If an error is detected, pressing <F1> will enter Setup and the BIOS setting can be adjusted to fix the problem. This normally happens when upgrading the hardware and not setting the BIOS to recognize it.

Hit "Delete" Message Display

This option tells the system to display or not display the "Hit Delete to Enter Setup" message. The settings are **Enabled** and Disabled.

Internal Cache

This option is for enabling or disabling the internal CPU L1 cache. Settings include Disabled, Write-Thru and **Write-Back**. Disabled: This option prevents the system from using the internal CPU L1 cache. This setting should be used to slow the computer system down or to troubleshoot error messages. Write-Thru: This option allows the computer system to use the internal CPU L1 cache as Write-Through cache. Write-Through cache is slower than Write-Back cache. It performs write operations to the internal L1 CPU cache and system memory simultaneously. Write-Back This option allows the computer system to use the internal CPU L1 cache as Write-Back cache. Write-Back cache is faster than Write-Through cache. Write-Back cache is a caching method in which modifications to data in the cache aren't copied to the cache source until absolutely necessary. Write-back caching is available on all CPUs supported by this BIOS. With these CPUs, write operations stored in the L1 cache aren't copied to main memory until absolutely necessary. This is the default setting.

External Cache

This option is for enabling or disabling the internal CPU L2 cache. Settings include Disabled, Write-Thru and **Write-Back**. See description above.

System BIOS Cacheable

This option enables you to move the system BIOS to the memory cache to improve performance. Settings are **Enabled** and Disabled.

Event Log Configuration

Event Logging

This option **Enables** or Disables the logging of events. You can use this screen to select options for the Event Log Configuration Settings. You can access sub screens to view the event log and mark all events as read. Use the up and down arrow keys to select an item, and the plus (+) and minus (-) keys to change the option setting. The settings are described on the following pages. The screen is shown below.

ECC Event Logging

This option Enables or **Disables** the logging of ECC events. The events logged by AMIBIOS are post errors such as a bad BIOS, floppy errors, or hard drive errors.

Clear All Event Logs

This option can be used to tell the system to clear the event log on the next boot up. The settings are **No** and Yes.

View Event Log

Highlighting this and pressing <Enter> will allow you to view the unread events from the event log area.

Mark All Events as Read

This allows the user to to mark all events as having been "read". The settings are OK and Cancel.

Peripheral Device Configuration

Onboard SCSI

This option allows you to Enable the onboard SCSI. The settings are **Enabled** and Disabled.

Onboard LAN

This option allows you to Enable the onboard LAN. The settings are **Enabled** and Disabled.

Power Lost Control

This option determines how the system will respond when power is reapplied after a power loss condition. **Always On** means the system will automatically start up when power is reapplied. **Always Off** means you must push the main power button to restart the system after power is restored.

Health Monitor Features

The BIOS continuously monitors the health of your system by measuring certain voltage levels and temperatures.

CPU Overheat Warning

This option allows you to **Enable** or Disable a system overheat warning signal, used to notify you in the event of a dangerous rise in heat levels.

CPU Overheat Warning

This option allows you to specify the temperature threshold that, when exceeded, will trigger the overheat warning alarm.

The rest of the Health Monitor menu lists various voltages and temperatures as they are currently being measured. These include CPU temperature, CPU voltage, the rpms of the CPU, chassis and thermal control fans as well as the primary voltage levels used by the system: +3.3V, +5V, +12V and -12V.

4-5 Chipset Setup

Choose Chipset Setup from the AMIBIOS Setup Utility main menu. The screen is shown below. All Chipset Setup options are described following the screen. You can use this screen to select options for the GHCH Configuration.

BIOS SETUP UTILITY							
Main	Advanced	Chipset	PCIPnP	Power	Boot	Security	Exit
						Options for MCH	
C000,16k	Shadow		[Cached/WP]				
C400,16k	Shadow		[Cached/WP]				
C800,16k	Shadow		[Disabled]				
CC00,16k	Shadow		[Disabled]				
D000,16k	Shadow		[Disabled]				
D400,16k	Shadow		[Disabled]				
D800,16k	Shadow		[Disabled]				
DC00,16k	Shadow		[Disabled]				
Act to Deact			[6 CLKS]				
Act to Read/Write			[3 CLKS]				
RAS Precharge Time			[3 CLKS]				↔ Select Screen
RA Cycle Time			[8]				↑↓ Select Item
Write to Deact			[3 CLKS]				+ - Change Option
SDRAM CAS Latency			[3]				F1 General Help
ISA IO Cycle Delay			[1.5 BCLK]				F10 Save and Exit
MPS 1.4 Support			[Enabled]				ESC Exit
V02.03 (C)Copyright 1985-2000, American Megatrends, Inc.							

C000, 16k Shadow

C400, 16k Shadow

C800, 16k Shadow

CC00, 16k Shadow

D000, 16k Shadow

D400, 16k Shadow

D800, 16k Shadow

DC00, 16k Shadow

These options specify how the 16 KB of video ROM at each of the above addresses is treated. When Disabled, the contents of the video ROM are not copied to RAM. When Enabled, the contents of 16 KB of video ROM beginning at the above address are copied (shadowed) from ROM to RAM for faster application. When set to Cached/WP, the contents of 16 KB of video ROM beginning at the above address are copied (shadowed) from ROM to RAM and can be written to or read from cache memory. The settings for this option are Disabled, Enabled and Cached/WP. (The optimal settings are Cached/WP for C000 and C400 and Disabled for all the other settings.

Act to Deact

This settings for this option are **6 CLKS** and 5 CLKS.

Act to Read/Write

This settings for this option are **3 CLKS** and 2 CLKS.

RAS Precharge Time

The precharge time is the number of cycles it takes for the RAS to accumulate a charge before a DRAM refresh. Insufficient recharge time may cause the DRAM to lose data. The settings are **3 CLKS** (which is more stable) and 2 CLKS. RAS stands for Row Address Strobe.

System Memory Frequency

This option allows the system memory frequency to be adjusted. The settings are 100 MHz (for PC100 memory), 133 MHz (for PC133 memory) and **Auto**, which allows the system memory frequency to auto select itself

RAS Cycle Time

This option defines the RAS cycle time. Settings include 10 CLKS, **9 CLKS**, 8 CLKS and 7 CLKS.

Write to Deact

This settings for this option are **3 CLKS** and 2 CLKS.

SDRAM CAS Latency

This settings for this option are **CAS Latency 3** and CAS Latency 2. CAS stands for Column Address Strobe.

ISA IO Cycle Delay

This settings for this option are Full Delay, **1.5 BCLK**, 2.5 BCLK and 3.5 BCLK.

MPS 1.4 Support

The settings for this option are **Enabled** and Disabled.

4-6 PCI PnP Setup

Choose PCI/PnP Setup from the AMIBIOS Setup main menu. All PCI/PnP options are described in this section. The PCI/PnP Setup screen is shown below.

BIOS SETUP UTILITY							
Main	Advanced	Chipset	PCIPnP	Power	Boot	Security	Exit
Plug & Play O/S			[No]	No: lets the BIOS configure all the devices in the system			
Reset Config Data			[No]	Yes: lets the operating system configure Plug and Play (PnP) devices not required for boot if your system has a Plug and Play operating system.			
PCI Latency Timer			[64]				
Allocate IRQ to VGA			[Yes]				
Palette Snooping			[Disabled]				
PCI IDE BusMaster			[Disabled]				
OffBoard PCI/ISA IDE Card			[Auto]				
USB Function			[Enabled]				
			[Available]	←→ Select Screen			
IRQ3			[Available]	↑↓ Select Item			
IRQ4			[Available]	+- Change Option			
IRQ5			[Available]	F1 General Help			
IRQ7			[Available]	F10 Save and Exit			
IRQ9			[Available]	ESC Exit			
IRQ10			[Available]				
V02.03 (C)Copyright 1985-2000, American Megatrends, Inc.							

Plug & Play OS

Choose the **No** setting for computers that do not meet the Plug and Play specifications, which will allow the BIOS to configure all the devices in the system. Choosing the Yes setting lets the operating system configure PnP devices that are not required for boot up (if the system has a PnP operating system). The operating system would have the ability to change interrupt, I/O, and DMA settings. Set this option if the system is running Windows 95®, Windows 98® or Windows 2000®. Other operating systems are also PnP-aware.

Reset Configuration Data

Choosing the Yes setting will cause the PnP configuration data in the BIOS to be cleared on the next boot up. Choosing the **No** setting does not force PnP data to be cleared on the next boot.

PCI Latency Timer

This option specifies the latency timing of the PCI clocks for all PCI devices. Settings include 32, **64**, 96, 128, 160, 192, 224 and 248 PCI clocks.

Allocate IRQ to PCI VGA

This option lets you allocate an interrupt request (IRQ) to the PCI VGA adapter card (if used). The settings are **Yes** and No.

Palette Snooping

When enabled, this option informs PCI devices that an ISA graphics device is installed. The settings are **Disabled** and Enabled. This does not necessarily indicate a physical ISA adapter card. The graphics chipset can be mounted on a PCI card. Always check with your adapter card manuals first, before modifying the default settings in the BIOS.

PCI IDE BusMaster

The settings for this option are **Disabled** and Enabled. Enable to specify that the IDE controller on the PCI bus has bus mastering capabilities.

USB Function

The settings for this option are Disabled and **Enabled**. Disabled prevents the use of the USB ports and Enabled allows the use of the USB ports.

PCI Slot-1 IRQ Preference

This option allows you to change the IRQ for PCI slot 1. The settings are **Auto**, 3, 4, 5, 7, 9, 10, 11, 12, 14, and 15. The Auto setting lets the BIOS assign the IRQ.

PCI Slot-2 IRQ Preference

This option allows you to change the IRQ for PCI slot 2. The settings are **Auto**, 3, 4, 5, 7, 9, 10, 11, 12, 14, and 15. The Auto setting lets the BIOS assign the IRQ.

PCI Slot-3 IRQ Preference

This option allows you to change the IRQ for PCI slot 3. The settings are **Auto**, 3, 4, 5, 7, 9, 10, 11, 12, 14, and 15. The Auto setting lets the BIOS assign the IRQ.

PCI Slot-4 IRQ Preference

This option allows you to change the IRQ for PCI slot 4. The settings are **Auto**, 3, 4, 5, 7, 9, 10, 11, 12, 14, and 15. The Auto setting lets the BIOS assign the IRQ.

Onboard LAN IRQ Preference

This option allows you to change the IRQ for the onboard LAN. The settings are **Auto**, 3, 4, 5, 7, 9, 10, 11, 12, 14, and 15. The Auto setting lets the BIOS assign the IRQ.

PCI Slot-5 IRQ Preference

This option allows you to change the IRQ for PCI slot 5. The settings are **Auto**, 3, 4, 5, 7, 9, 10, 11, 12, 14, and 15. The Auto setting lets the BIOS assign the IRQ.

PCI Slot-6 IRQ Preference

This option allows you to change the IRQ for PCI slot 6. The settings are **Auto**, 3, 4, 5, 7, 9, 10, 11, 12, 14, and 15. The Auto setting lets the BIOS assign the IRQ.

Onboard SCSI IRQ Preference

This option allows you to change the IRQ for the onboard SCSI. The settings are **Auto**, 3, 4, 5, 7, 9, 10, 11, 12, 14, and 15. The Auto setting lets the BIOS assign the IRQ.

IRQ 3

IRQ 4

IRQ 5

IRQ 7

IRQ 9

IRQ 10

IRQ 11

IRQ 14

IRQ 15

The settings for the above options are **Available** and **Reserved**. Available allows the specified IRQ to be available for use by PCI/PnP devices. Reserved means the specified IRQ is reserved for use by Legacy ISA devices.

DMA Channel 0

DMA Channel 1

DMA Channel 3

DMA Channel 5

DMA Channel 6

DMA Channel 7

Each of the above list of DMA channel setting options can be set to **Available** and **Reserved**. Available means the specified DMA channel is available for use by PCI/PnP devices. Reserved means the specified DMA channel is reserved for use by Legacy ISA devices.

Reserved Memory Size

This option specifies the size of a memory area to be reserved for Legacy ISA adapter cards. The settings are **Disabled**, 16k, 32k and 64k.

4-7 Power Setup

Choose Power Setup from the AMIBIOS Setup main menu. All Power Setup options are described in this section. The Power Setup screen is shown below.

BIOS SETUP UTILITY							
Main	Advanced	Chipset	PCIPnP	Power	Boot	Security	Exit
ACPI Aware O/S				[Yes]			
Power Management				[Enabled]			
Power Button Mode				[On/Off]			
Sleep Button Enable				[Suspend]			
Green PC Monitor Power State				[Suspend]			
Video Power Down Mode				[Suspend]			
Hard Disk Power Down Mode				[Suspend]			
Inactivity Timer				[Off]			
Suspend Timeout (Minutes)				[Off]			
IRQ1				[Monitor]			
IRQ3				[Ignore]			
IRQ4				[Ignore]			
IRQ5				[Ignore]			↔ Select Screen
IRQ6				[Ignore]			↑↓ Select Item
IRQ7				[Ignore]			+ - Change Option
IRQ9				[Ignore]			F1 General Help
IRQ10				[Ignore]			F10 Save and Exit
							ESC Exit
V02.03 (C)Copyright 1985-2000, American Megatrends, Inc.							

ACPI Aware O/S

This option allows the system to utilize Intel's ACPI (Advanced Configuration and Power Interface) specification. Settings are **No** and **Yes**. DOS®, Windows 3.x®, and Windows NT® are examples of non-ACPI aware operating systems. Windows 95®, Windows 98®, Windows ME® and Windows 2000® are examples of ACPI aware operating systems.

Power Management

This option allows you to select using APM (Advanced Power Management). The settings are **Disabled** and **Enabled**.

Power Button Mode

This option specifies how the external power button on the computer chassis functions. When set to **On/Off**, depressing the power button turns the computer on or off. When set to **Suspend**, depressing the power button places the computer in Suspend mode or Full On power mode. The **Standby** setting places the computer in Standby or Full On mode.

Sleep Button Enable

This option is to enable the use of the sleep button. The settings are **Suspend** and **Disable**.

Green PC Monitor Power State

This option specifies the power state that a green PC-compliant monitor enters when BIOS places it in a power saving state after the specified period of display inactivity has expired. The settings include **Standby**, **Suspend** and **Off**.

Video Power Down Mode

This option specifies the power state that the VGA video subsystem enters after the specified period of display inactivity has expired. The settings include **Disabled**, **Standby** and **Suspend**.

Hard Disk Power Down Mode

This option specifies the power conserving state that the hard disk drive(s) enters after the specified period of inactivity has expired. The settings include **Disabled**, **Standby** and **Suspend**.

Inactivity Timer

This option specifies the length of hard disk inactivity time that should expire before entering the power conserving state. The settings include **Off**, 1, 5, 10, 20, 30, 60 and 120 (minutes).

Suspend Timeout

This option specifies if BIOS is to monitor for display activity when in a power saving state. The settings include **Off**, 1, 2, 3, 4, 5, 6, 7, 8, 9 and 10 (minutes).

IRQ1

IRQ3

IRQ4

IRQ5

IRQ6

IRQ7

IRQ9

IRQ10

IRQ11

IRQ12

IRQ14

IRQ15

With the above options, you can monitor each interrupt request and resume the system's normal power up state when activated. Settings are Ignore and Monitor. All IRQs are defaulted to Ignore except for IRQ 1, 12 and 14, which default to Monitor.

USB Controller Resume

This allows you to wake up the system from a USB device. The settings for this option **Disabled** and **Enabled**.

4-8 Boot Setup

Choose Boot Setup from the AMIBIOS Setup main menu. All Boot Setup options are described in this section. The Boot Setup screen is shown below.

BIOS SETUP UTILITY							
Main	Advanced	Chipset	PCIPnP	Power	Boot	Security	Exit
>	Boot Device Priority						
>	Hard Disk Drives						
>	Removable Devices						
>	ATAPI CDROM Drives						
					↔	Select Screenshot	
					↑↓	Select Item	
					Enter	Go to Sub Screen	
					F1	General Help	
					F10	Save and Exit	
					ESC	Exit	
V02.03 (C)Copyright 1985-2000, American Megatrends, Inc.							

Boot Device Priority

1st Boot Device

This option is used to specify the order of the boot sequence that will be followed from the available system devices. The settings for the 1st Boot Device are **Removable Device**, Hard Drive and ATAPI CDROM.

2nd Boot Device

The settings for the 2nd Boot Device are Removable Device, Hard Drive and **ATAPI CDROM**.

3rd Boot Device

The settings for the 3rd Boot Device are Removable Device, **Hard Drive** and ATAPI CDROM.

Hard Disk Drives

Use this screen to view the hard drives that have been auto-detected or entered manually on your system.

Removable Devices

Use this screen to view the removable devices that have been auto-detected or entered manually on your system.

ATAPI CDROM Drives

Use this screen to view the ATAPI CDROM drives that have been auto-detected or entered manually on your system.

4-9 Security Setup

Choose Security Setup from the AMIBIOS Setup main menu. All Security Setup options are described in this section. The Security Setup screen is shown below.

BIOS SETUP UTILITY							
Main	Advanced	Chipset	PCIPnP	Power	Boot	Security	Exit
Supervisor Password :						Not Installed	
User Password :						Not Installed	
> <u>Change Supervisor Password</u>							
> Change User Password							
> Clear User Password							
Boot Sector Virus Protection						[Disabled]	
						Install or Change the password.	
						↔ Select Screen	
						↑↓ Select Item	
						Enter Go to Sub Scr	
						F1 General Help	
						F10 Save and Exit	
						ESC Exit	
V02.03 (C)Copyright 1985-2000, American Megatrends, Inc.							

Supervisor Password

User Password

AMIBIOS provides both Supervisor and User password functions. If you use both passwords, the Supervisor password must be set first. The system can be configured so that all users must enter a password every time the system boots or when AMIBIOS Setup is executed, using either or both the Supervisor password or User password. The Supervisor and User passwords activate two different levels of password security. If you select password support, you are prompted for a 1 – 6 character password. Type the password on the keyboard. The password does not appear on the screen when typed. Make sure you write it down. If you forget it, you must clear CMOS and reconfigure. **Remember your Password!** Keep a record of the new password when the password is changed. If you forget the password, you must erase the system configuration information in CMOS.

Change Supervisor Password

This option allows you to change a supervisor password that was entered previously.

Change User Password

This option allows you to change a user password that was entered previously.

Clear User Password

Use this option to clear the user password so that it is not required to be entered when the system boots up.

Boot Sector Virus Protection

This option allows you to enable or disable a virus detection program to protect the boot sector of your hard disk drive. The settings for this option **Disabled** and Enabled. If Enabled, AMIBIOS will display a warning when any program (or virus) issues a Disk Format command or attempts to write to the boot sector of the hard disk drive.

4-10 Exit Setup

Choose Exit Setup from the AMIBIOS Setup main menu. All Exit Setup options are described in this section. The Exit Setup screen is shown below.

BIOS SETUP UTILITY							
Main	Advanced	Chipset	PCIPnP	Power	Boot	Security	Exit
>	<u>Exit Saving Changes</u>						Exit system setup with saving the changes.
>	Exit Discarding Changes						
>	Load Optimal Defaults						
>	Load Fail-Safe Defaults						
>	Discard Changes						
							↔ Select Screen ↑↓ Select Item Enter Go to Sub Screen F1 General Help F10 Save and Exit ESC Exit
V02.03 (C)Copyright 1985-2000, American Megatrends, Inc.							

Exit Saving Changes

Highlighting this setting and then pressing <Enter> will save any changes you made in the BIOS Setup program and then exit. Your system should then continue with the boot up procedure.

Exit Discarding Changes

Highlighting this setting and then pressing <Enter> will ignore any changes you made in the BIOS Setup program and then exit. Your system should then continue with the boot up procedure.

Load Optimal Defaults

Highlighting this setting and then pressing <Enter> provides the optimum performance settings for all devices and system features.

Load Failsafe Defaults

Highlighting this setting and then pressing <Enter> provides the safest set of parameters for the system. Use them if the system is behaving erratically.

Discard Changes

Highlighting this setting and then pressing <Enter> will ignore any changes you made in the BIOS Setup program but will not exit the BIOS Setup program.

Notes

Appendix A

BIOS Error Beep Codes & Messages

During the POST (Power-On Self-Test) routines, which are performed each time the system is powered on, errors may occur.

Non-fatal errors are those which, in most cases, allow the system to continue the boot-up process. The error messages normally appear on the screen.

Fatal errors are those which will not allow the system to continue the boot-up procedure. If a fatal error occurs, you should consult with your system manufacturer for possible repairs.

These fatal errors are usually communicated through a series of audible beeps. The numbers on the following page correspond to the number of beeps for the error described.

AMIBIOS Error Beep Codes

POST Error Beep Codes

- 1 beep:** Refresh failure - the memory refresh circuitry on the motherboard is faulty. (Fatal error)
- 3 beeps:** Base 64KB memory failure - memory failure occurred in the first 64KB of memory. (Fatal error)
- 6 beeps:** Keyboard controller Gate A20 failure. The keyboard controller may be bad. The BIOS cannot switch to protected mode. (Fatal error)
- 7 beeps:** Processor exception interrupt error. The CPU generated an exception interrupt. (Fatal error)
- 8 beeps:** Display memory read/write error. The system video adapter is either missing or its memory is faulty. This is not a fatal error.

Bootblock Error Beep Codes

- 2 beeps:** BIOS ROM file absent - the BIOS was unable to find the specific file name required to flash the BIOS.
- 4 beeps:** Flash program successful.
- 5 beeps:** Media read error. The floppy or ATAPI media is not present or cannot be read.
- 7 beeps:** Flash not present. The BIOS was unable to detect the presence of a flash device.
- 10 beeps:** Flash erase error - the flash device could not be properly erased.
- 11 beeps:** Flash program error.
- 12 beeps:** BIOS ROM file incorrect size.
- 13 beeps:** BIOS ROM image mismatch. The BIOS ROM file layout configuration does not match the image present in the flash device.

If you hear...	it's because...
5 short and 1 long beeps	no memory detected in system
6 short and 1 long beeps	EDO memory detected in system
7 short and 1 long beeps	SMBUS (System Management Bus) error

Notes

Appendix B

AMIBIOS POST Diagnostic Error Messages

This section describes the power-on self-tests (POST) port 80 codes for the AMIBIOS.

Check

<u>Point</u>	<u>Description</u>
00	Code copying to specific areas is done. Passing control to INT 19h boot loader next.
03	NMI is Disabled. Next, checking for a soft reset or a power-on condition.
05	The BIOS stack has been built. Next, disabling cache memory.
06	Uncompressing the post code unit next.
07	Next, initializing the CPU init and the CPU data area.
08	The CMOS checksum calculation is done next.
0B	Next, performing any required initialization before keyboard BAT command is issued.
0C	The keyboard controller I/B is free. Next, issuing the BAT command to the keyboard controller.
0E	The keyboard controller BAT command result has been verified. Next, performing any necessary initialization after the keyboard controller BAT command test.
0F	The initialization after the keyboard controller BAT command test is done. The keyboard command byte is written next.

Check Point	<u>Description</u>
10	The keyboard controller command byte is written. Next, issuing the pin 23 and 24 blocking and unblocking commands.
11	Next, checking if the <End or <Ins> keys were pressed during power on. Initializing CMOS RAM if the Initialize CMOS RAM in every boot AMIBIOS POST option was set in AMIBCP or the <End> key was pressed.
12	Next, disabling DMA controllers 1 and 2 and interrupt controllers 1 and 2.
13	The video display has been disabled. Port B has been initialized. Next, initializing the chipset.
14	The 8254 timer test will begin next.
19	The 8254 timer test is over. Starting the memory refresh test next.
1A	The memory refresh test line is toggling. Checking the 15 second on/off time next.
23	Reading the 8042 input port and disabling the MEGAKEY Green PC feature next. Making the BIOS code segment writable and performing any necessary configuration before initializing the interrupt vectors.
24	The configuration required before interrupt vector initialization has completed. Interrupt vector initialization is done. Clearing the password if the POST DIAG switch is on.
25	Interrupt vector initialization is done. Clearing the password if the POST DIAG Switch is on.
27	Any initialization before setting video mode will be done next.

Check Point	Description
28	Initialization before setting the video mode is complete. Configuring the monochrome mode and color mode settings next.
2A	Bus initialization system, static, output devices will be done next, if present.
2B	Passing control to the video ROM to perform any required configuration before the video ROM test.
2C	All necessary processing before passing control to the video ROM is done. Looking for the video ROM next and passing control to it.
2D	The video ROM has returned control to BIOS POST. Performing any required processing after the video ROM had control.
2E	Completed post-video ROM test processing. If the EGA/VGA controller is not found, performing the display memory read/write test next.
2F	The EGA/VGA controller was not found. The display memory read/write test is about to begin.
30	The display memory read/write test passed. Look for retrace checking next.
31	The display memory read/write test or retrace checking failed. Performing the alternate display memory read/write test next.
32	The alternate display memory read/write test passed. Looking for alternate display retrace checking next.
34	Video display checking is over. Setting the display mode next.
37	The display mode is set. Displaying the power on message next.

Check Point	<u>Description</u>
38	Initializing the bus input, IPL, and general devices next, if present.
39	Displaying bus initialization error messages.
3A	The new cursor position has been read and saved. Displaying the Hit message next.
40	Preparing the descriptor tables next.
42	The descriptor tables are prepared. Entering protected mode for the memory test next.
43	Entered protected mode. Enabling interrupts for diagnostics mode next.
44	Interrupts enabled if the diagnostics switch is on. Initializing data to check memory wraparound at 0:0 next.
45	Data initialized. Checking for memory wraparound at 0:0 and finding the total system memory size next.
46	The memory wraparound test has completed. The memory size calculation has been completed. Writing patterns to test memory next.
47	The memory pattern has been written to extended memory. Writing patterns to the base 640 KB memory next.
48	Patterns written in base memory. Determining the amount of memory below 1 MB next.
49	The amount of memory below 1 MB has been found and verified. Determining the amount of memory above 1 MB memory next.
4B	The amount of memory above 1 MB has been found and verified. Checking for a soft reset and clearing the memory below 1 MB for the soft reset next. If this is a power on situation, going to checkpoint 4Eh next.

Check Point	Description
4C	The memory below 1 MB has been cleared via a soft reset. Clearing the memory above 1 MB next.
4D	The memory above 1 MB has been cleared via a soft reset. Saving the memory size next. Going to checkpoint 52h next.
4E	The memory test started, but not as the result of a soft reset. Displaying the first 64 KB memory size next.
4F	The memory size display has started. The display is updated during the memory test. Performing the sequential and random memory test next.
50	The memory below 1 MB has been tested and initialized. Adjusting the displayed memory size for relocation and shadowing next.
51	The memory size display was adjusted for relocation and shadowing. Testing the memory above 1 MB next.
52	The memory above 1 MB has been tested and initialized. Saving the memory size information next.
53	The memory size information and the CPU registers are saved. Entering real mode next.
54	Shutdown was successful. The CPU is in real mode. Disabling the Gate A20 line, parity, and the NMI next.
57	The A20 address line, parity, and the NMI are disabled. Adjusting the memory size depending on relocation and shadowing next.
58	The memory size was adjusted for relocation and shadowing. Clearing the Hit message next.
59	The Hit message is cleared. The <WAIT> message is displayed. Starting the DMA and interrupt controller test next.

Check Point	Description
60	The DMA page register test passed. Performing the DMA Controller 1 base register test next.
62	The DMA controller 1 base register test passed. Performing the DMA controller 2 base register test next.
65	The DMA controller 2 base register test passed. Programming DMA controllers 1 and 2 next.
66	Completed programming DMA controllers 1 and 2. Initializing the 8259 interrupt controller next.
7F	Extended NMI source enabling is in progress.
80	The keyboard test has started. Clearing the output buffer and checking for stuck keys. Issuing the keyboard reset command next.
81	A keyboard reset error or stuck key was found. Issuing the keyboard controller interface test command next.
82	The keyboard controller interface test completed. Writing the command byte and initializing the circular buffer next.
83	The command byte was written and global data initialization has been completed. Checking for a locked key next.
84	Locked key checking is over. Checking for a memory size mismatch with CMOS RAM data next.
85	The memory size check is done. Displaying a soft error and checking for a password or bypassing WINBIOS Setup next.
86	The password was checked. Performing any required programming before WINBIOS Setup next.

Check Point	Description
87	The programming before WINBIOS Setup has been completed. Uncompressing the WINBIOS Setup code and executing the AMIBIOS Setup or WINBIOS Setup utility next.
88	Returned from WINBIOS Setup and cleared the screen. Performing any necessary programming after WINBIOS Setup next.
89	The programming after WINBIOS Setup has been completed. Displaying the power-on screen message next.
8B	The first screen message has been displayed. The <WAIT...> message is displayed. Performing the PS/2 mouse check and extended BIOS data area allocation check next.
8C	Programming the WINBIOS Setup options next.
8D	The WINBIOS Setup options are programmed. Resetting the hard disk controller next.
8F	The hard disk controller has been reset. Configuring the floppy drive controller next.
91	The floppy drive controller has been configured. Configuring the hard disk drive controller next.
95	Initializing the bus option ROMs from C800 next.
96	Initializing before passing control to the adaptor ROM at C800.
97	Initialization before the C800 adaptor ROM gains control has been completed. The adaptor ROM check is next.
98	The adaptor ROM had control and has now returned control to BIOS POST. Performing any required processing after the option ROM returned control.

Check Point	<u>Description</u>
99	Any initialization required after the option ROM test has been completed. Configuring the timer data area and printer base address next.
9A	Set the timer and printer base addresses. Setting the RS-232 base address next.
9B	Returned after setting the RS-232 base address. Performing any required initialization before the Coprocessor test next.
9C	Required initialization before the Coprocessor test is over. Initializing the Coprocessor next.
9D	Coprocessor initialized. Performing any required initialization after the Coprocessor test next.
9E	Initialization after the Coprocessor test is complete. Checking the extended keyboard, keyboard ID, and Num Lock key next. Issuing the keyboard ID command next.
A2	Displaying any soft errors next.
A3	The soft error display has completed. Setting the keyboard typematic rate next.
A4	The keyboard typematic rate is set. Programming the memory wait states next.
A5	Memory wait state programming is over. Clearing the screen and enabling parity and the NMI next.
A7	NMI and parity enabled. Performing any initialization required before passing control to the adaptor ROM at E000 next.
A8	Initialization before passing control to the adaptor ROM at E000h completed. Passing control to the adaptor ROM at E000h next.

Check Point	Description
A9	Returned from adaptor ROM at E000h control. Next, performing any initialization required after the E000 option ROM had control.
AA	Initialization after E000 option ROM control has completed. Displaying the system configuration next.
AB	Building the multiprocessor table, if necessary. POST next.
B0	The system configuration is displayed.
AC	Uncompressing the DMI data and initializing DMI.
B1	Copying any code to specific areas.
D0h	The NMI is disabled. Power on delay is starting. Next, the initialization code checksum will be verified.
D1h	Initializing the DMA controller. Performing the keyboard controller BAT test. Starting memory refresh, and entering 4 GB flat mode next.
D3h	Starting memory sizing next.
D4h	Returning to real mode. Executing any OEM patches and setting the stack next.
D5h	Passing control to the uncompressed code in shadow RAM at E000:0000h. The initialization code is copied to segment 0 and control will be transferred to segment 0.
D6h	Control is in segment 0. Next, checking if <Ctrl><Home> was pressed and verifying the system BIOS checksum.
	If either <Ctrl><Home> was pressed or the system BIOS checksum is bad, next the system will go to checkpoint code E0h. Otherwise, going to checkpoint code D7h.

Notes