

# Preliminary W25P222A



## 64K × 32 BURST PIPELINED HIGH-SPEED CMOS STATIC RAM

### GENERAL DESCRIPTION

The W25P222A is a high-speed, low-power, synchronous-burst pipelined CMOS static RAM organized as 65,536 × 32 bits that operates on a single 3.3-volt power supply. A built-in two-bit burst address counter supports both Pentium™ burst mode and linear burst mode. The mode to be executed is controlled by the  $\overline{\text{LBO}}$  pin. Pipelining or non-pipelining of the data outputs is controlled by the  $\overline{\text{FT}}$  pin. A snooze mode reduces power dissipation.

The W25P222A supports both 2T/2T mode and 2T/1T mode, which can be selected by pin 42. The default mode is 2T/1T, with pin 42 low. To switch to 2T/2T mode, bias pin 42 to  $V_{\text{DDQ}}$ . The state of pin 42 should not be changed after power up. The 2T/2T mode will sustain one cycle of valid data output in a burst read cycle when the device is deselected by  $\text{CE2}/\overline{\text{CE3}}$ . This mode supports 3-1-1-1-1-1-1-1 in a two-bank, back-to-back burst read cycle. On the other hand, the 2T/1T mode disables data output within one cycle in a burst read cycle when the device is deselected by  $\text{CE2}/\overline{\text{CE3}}$ . In this mode, the device supports only 3-1-1-1-2-1-1-1 in a two-bank, back-to-back burst read cycle.

### FEATURES

- Synchronous operation
- High-speed access time: 4/4.5 nS (max.)
- Single +3.3V power supply
- Individual byte write capability
- 3.3V LVTTTL compatible I/O
- Clock-controlled and registered input
- Asynchronous output enable
- Pipelined/non-pipelined data output capability
- Supports snooze mode (low-power state)
- Internal burst counter supports Intel burst mode & linear burst mode
- Supports both 2T/2T & 2T/1T mode
- Packaged in 100-pin QFP or TQFP

### BLOCK DIAGRAM

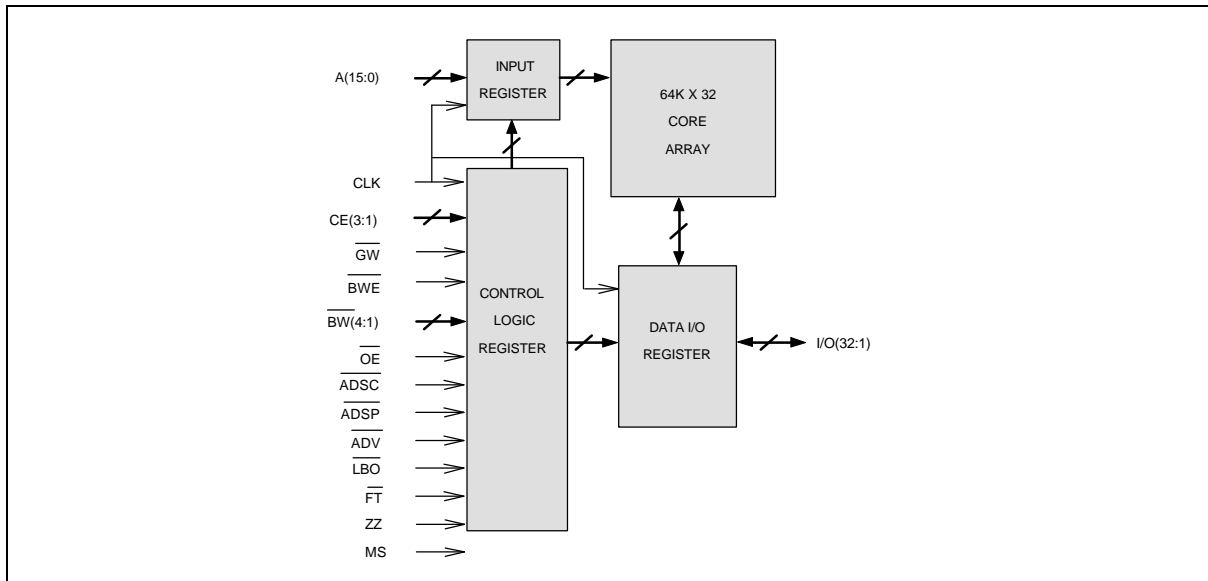

## PIN CONFIGURATION

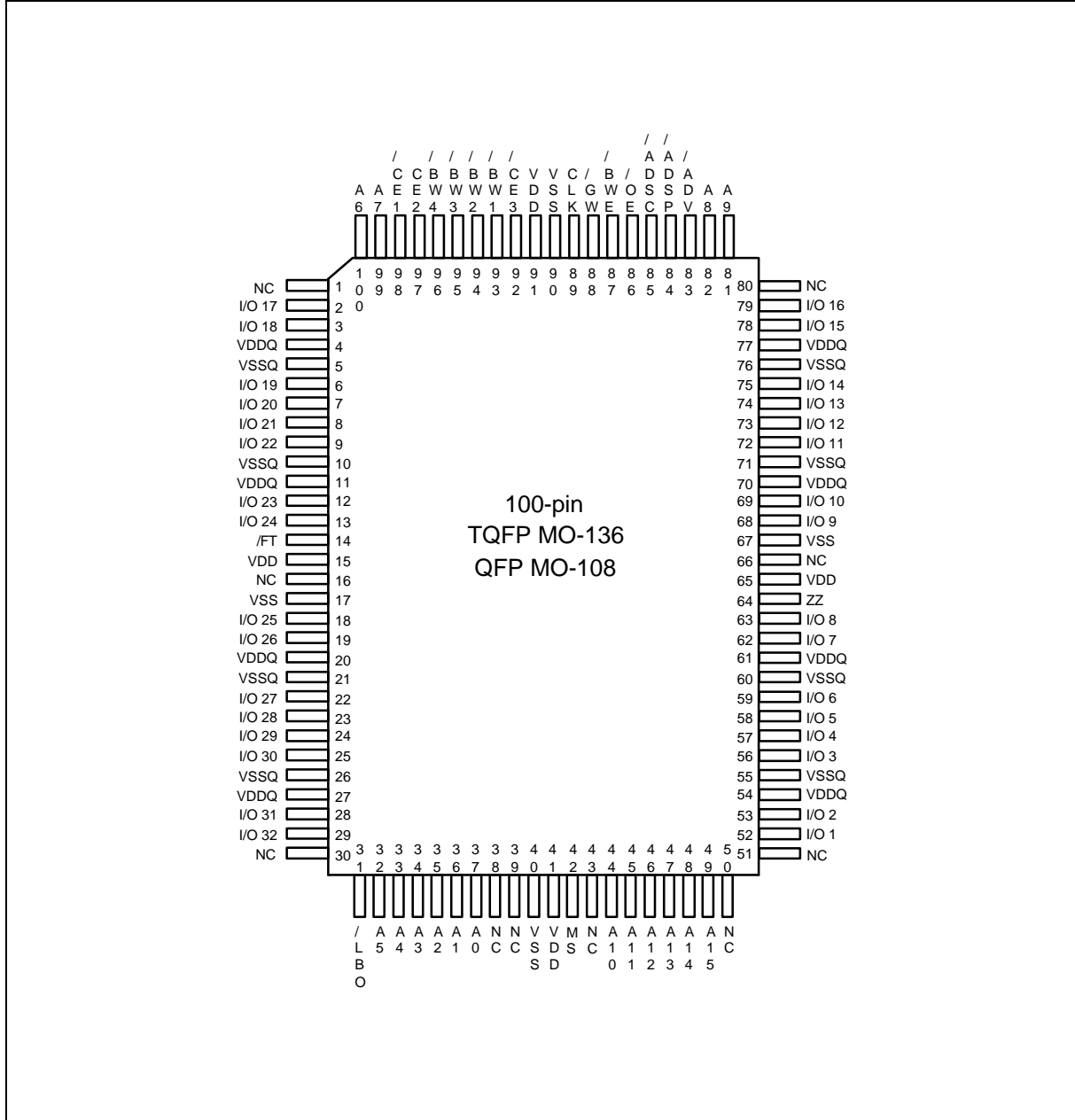

# Preliminary W25P222A



## PIN DESCRIPTION

SYMBOL	TYPE	DESCRIPTION
A0–A15	Input, Synchronous	Host Address
I/O1–I/O32	I/O, Synchronous	Data Inputs/Outputs
CLK	Input, Clock	Processor Host Bus Clock
$\overline{CE1}$ , $\overline{CE2}$ , $\overline{CE3}$	Input, Synchronous	Chip Enables
$\overline{GW}$	Input, Synchronous	Global Write
$\overline{BWE}$	Input, Synchronous	Byte Write Enable from Cache Controller
$\overline{BW1}$ – $\overline{BW4}$	Input, Synchronous	Host Bus Byte Enables used with $\overline{BWE}$
$\overline{OE}$	Input, Asynchronous	Output Enable Input
$\overline{ADV}$	Input, Synchronous	Internal Burst Address Counter Advance
$\overline{ADSC}$	Input, Synchronous	Address Status from chip set
$\overline{ADSP}$	Input, Synchronous	Address Status from CPU
ZZ	Input, Asynchronous	Snooze Pin for Low-power State, internally pulled low
$\overline{FT}$	Input, Static	Connected to VSSQ: Device operates in flow-through (non-pipelined) mode. Connected to VDDQ or unconnected: Device operates in pipelined mode.
$\overline{LBO}$	Input, Static	Lower Address Burst Order Connected to VSSQ: Device operates in linear mode. Connected to VDDQ or unconnected: Device is in non-linear mode.
MS	Input, Static	Mode Select for 2T/2T or 2T/1T When unconnected or pulled low, device is in 2T/1T mode; if pulled high (VDDQ), device enters 2T/2T mode.
VDDQ		I/O Power Supply
VSSQ		I/O Ground
VDD		Power Supply
VSS		Ground
NC		No Connection

# Preliminary W25P222A



## TRUTH TABLE

CYCLE	ADDRESS USED	$\overline{CE1}$	CE2	$\overline{CE3}$	$\overline{ADSP}$	$\overline{ADSC}$	$\overline{ADV}$	$\overline{OE}$	DATA	WRITE*
Unselected	No	1	X	X	X	0	X	X	Hi-Z	X
Unselected	No	0	X	1	0	X	X	X	Hi-Z	X
Unselected	No	0	0	X	0	X	X	X	Hi-Z	X
Unselected	No	0	X	1	1	0	X	X	Hi-Z	X
Unselected	No	0	0	X	1	0	X	X	Hi-Z	X
Begin Read	External	0	1	0	0	X	X	X	Hi-Z	X
Begin Read	External	0	1	0	1	0	X	X	Hi-Z	Read
Continue Read	Next	X	X	X	1	1	0	1	Hi-Z	Read
Continue Read	Next	X	X	X	1	1	0	0	D-Out	Read
Continue Read	Next	1	X	X	X	1	0	1	Hi-Z	Read
Continue Read	Next	1	X	X	X	1	0	0	D-Out	Read
Suspend Read	Current	X	X	X	1	1	1	1	Hi-Z	Read
Suspend Read	Current	X	X	X	1	1	1	0	D-Out	Read
Suspend Read	Current	1	X	X	X	1	1	1	Hi-Z	Read
Suspend Read	Current	1	X	X	X	1	1	0	D-Out	Read
Begin Write	Current	X	X	X	1	1	1	X	Hi-Z	Write
Begin Write	Current	1	X	X	X	1	1	X	Hi-Z	Write
Begin Write	External	0	1	0	1	0	X	X	Hi-Z	Write
Continue Write	Next	X	X	X	1	1	0	X	Hi-Z	Write
Continue Write	Next	1	X	X	X	1	0	X	Hi-Z	Write
Suspend Write	Current	X	X	X	1	1	1	X	Hi-Z	Write
Suspend Write	Current	1	X	X	X	1	1	X	Hi-Z	Write

### Notes:

1. For a detailed definition of read/write, see the Write Table below.
2. An "X" means don't care, "1" means logic high, and "0" means logic low.
3. The  $\overline{OE}$  pin enables the data output but is not synchronous with the clock. All signals of the SRAM are sampled synchronous to the bus clock except for the  $\overline{OE}$  pin.
4. On a write cycle that follows a read cycle,  $\overline{OE}$  must be inactive prior to the start of the write cycle to allow write data to set up the SRAM.  $\overline{OE}$  must also disable the output buffer prior to the end of a write cycle to ensure the SRAM data hold timings are met.

# Preliminary W25P222A



## FUNCTIONAL DESCRIPTION

The W25P222A is a synchronous-burst pipelined SRAM designed for use in high-end personal computers. It supports two burst address sequences for Intel™ systems and linear mode, which can be controlled by the  $\overline{\text{LBO}}$  pin. The burst cycles are initiated by  $\overline{\text{ADSP}}$  or  $\overline{\text{ADSC}}$  and the burst counter is incremented whenever  $\overline{\text{ADV}}$  is sampled low. The device can also be switched to non-pipelined mode if necessary.

### Burst Address Sequence

	INTEL SYSTEM ( $\overline{\text{LBO}} = \text{VDDQ}$ )				LINEAR MODE ( $\overline{\text{LBO}} = \text{VSSQ}$ )			
	A[1:0]	A[1:0]	A[1:0]	A[1:0]	A[1:0]	A[1:0]	A[1:0]	A[1:0]
External Start Address	00	01	10	11	00	01	10	11
Second Address	01	00	11	10	01	10	11	00
Third Address	10	11	00	01	10	11	00	01
Fourth Address	11	10	01	00	11	00	01	10

The device supports several types of write mode operations.  $\overline{\text{BWE}}$  and  $\overline{\text{BW}} [4:1]$  support individual byte writes. The  $\overline{\text{BE}} [7:0]$  signals can be directly connected to the SRAM  $\overline{\text{BW}} [4:1]$ . The  $\overline{\text{GW}}$  signal is used to override the byte enable signals and allows the cache controller to write all bytes to the SRAM, no matter what the byte write enable signals are. The various write modes are indicated in the Write Table below. Note that in pipelined mode, the byte write enable signals are not latched by the SRAM with addresses but with data. In pipelined mode, the cache controller must ensure the SRAM latches both data and valid byte enable signals from the processor.

### WRITE TABLE

READ/WRITE FUNCTION	$\overline{\text{GW}}$	$\overline{\text{BWE}}$	$\overline{\text{BW4}}$	$\overline{\text{BW3}}$	$\overline{\text{BW2}}$	$\overline{\text{BW1}}$
Read	1	1	X	X	X	X
Read	1	0	1	1	1	1
Write byte 1 I/O1–I/O8	1	0	1	1	1	0
Write byte 2 I/O9–I/O16	1	0	1	1	0	1
Write byte 2, byte 1	1	0	1	1	0	0
Write byte 3 I/O17–I/O24	1	0	1	0	1	1
Write byte 3, byte 1	1	0	1	0	1	0
Write byte 3, byte 2	1	0	1	0	0	1
Write byte 3, byte 2, byte 1	1	0	1	0	0	0
Write byte 4 I/O25–I/O32	1	0	0	1	1	1
Write byte 4, byte 1	1	0	0	1	1	0

# Preliminary W25P222A



Write Table, continued

READ/WRITE FUNCTION	$\overline{GW}$	$\overline{BWE}$	$\overline{BW4}$	$\overline{BW3}$	$\overline{BW2}$	$\overline{BW1}$
Write byte 4, byte 2	1	0	0	1	0	1
Write byte 4, byte 2, byte 1	1	0	0	1	0	0
Write byte 4, byte 3	1	0	0	0	1	1
Write byte 4, byte 3, byte 1	1	0	0	0	1	0
Write byte 4, byte 3, byte 2	1	0	0	0	0	1
Write all bytes I/O1–I/O32	1	0	0	0	0	0
Write all bytes I/O1–I/O32	0	X	X	X	X	X

The ZZ state is a low-power state in which the device consumes less power than in the unselected mode. Enabling the ZZ pin for a fixed period of time will force the SRAM into the ZZ state. Pulling the ZZ pin low for a set period of time will wake up the SRAM again. While the SRAM is in ZZ mode, data retention is guaranteed, but the chip will not monitor any input signal except for the ZZ pin. In the unselected mode, on the other hand, all the input signals are monitored.

## ABSOLUTE MAXIMUM RATINGS

PARAMETER	RATING	UNIT
Core Supply Voltage to Vss	-0.5 to 4.6	V
I/O Supply Voltage to Vss	-0.5 to 4.6	V
Input/Output to Vssq Potential	Vssq -0.5 to VDDQ +0.5	V
Allowable Power Dissipation	1.0	W
Storage Temperature	-65 to 150	°C
Operating Temperature	0 to +70	°C

Note: Exposure to conditions beyond those listed under Absolute Maximum Ratings may adversely affect the life and reliability of the device.

# Preliminary W25P222A



## OPERATING CHARACTERISTICS

(V<sub>DD</sub>/V<sub>DDQ</sub> = 3.15V to 3.6V, V<sub>SS</sub>/V<sub>SSQ</sub> = 0V, T<sub>A</sub> = 0 to 70° C)

PARAMETER	SYM.	TEST CONDITIONS	MIN.	TYP	MAX.	UNIT
Input Low Voltage	V <sub>IL</sub>	-	-0.5	-	+0.8	V
Input High Voltage	V <sub>IH</sub>	-	+2.0	-	V <sub>DD</sub> +0.3	V
Input Leakage Current	I <sub>LI</sub>	V <sub>IN</sub> = V <sub>SSQ</sub> to V <sub>DDQ</sub>	-10	-	+10	μA
Output Leakage Current	I <sub>LO</sub>	V <sub>I/O</sub> = V <sub>SSQ</sub> to V <sub>DDQ</sub> , and data I/O pins in high-Z state defined in truth table	-10	-	+ 10	μA
Output Low Voltage	V <sub>OL</sub>	I <sub>OL</sub> = +8.0 mA	-	-	0.4	V
Output High Voltage	V <sub>OH</sub>	I <sub>OH</sub> = -4.0 mA	2.4	-	-	V
Operating Current	I <sub>DD</sub>	T <sub>CYC</sub> ≥ min., I/O = 0 mA	-	-	250	mA
Standby Current	I <sub>SB</sub>	Unselected mode defined in truth table, V <sub>IN</sub> , V <sub>IO</sub> = V <sub>IH</sub> (min.) / V <sub>IL</sub> (max.) T <sub>CYC</sub> ≥ min.	-	-	80	mA
ZZ Mode Current	I <sub>ZZ</sub>	ZZ mode, T <sub>CYC</sub> ≥ min.	-	-	5	mA

Note: Typical characteristics are measured at V<sub>DD</sub> = 3.3V, T<sub>A</sub> = 25° C.

## CAPACITANCE

(V<sub>DD</sub> = 3.3V, T<sub>A</sub> = 25° C, f = 1 MHz)

PARAMETER	SYM.	CONDITIONS	MAX.	UNIT
Input Capacitance	C <sub>IN</sub>	V <sub>IN</sub> = 0V	6	pF
Input/Output Capacitance	C <sub>I/O</sub>	V <sub>OUT</sub> = 0V	8	pF

Note: These parameters are sampled but not 100% tested.

## AC TEST CONDITIONS

PARAMETER	CONDITIONS
Input Pulse Levels	0V to 3V
Input Rise and Fall Times	2 nS
Input and Output Timing Reference Level	1.5V
Output Load	C <sub>L</sub> = 30 pF, I <sub>OH</sub> /I <sub>OL</sub> = -4 mA/8 mA

# Preliminary W25P222A



## AC TEST LOADS AND WAVEFORM

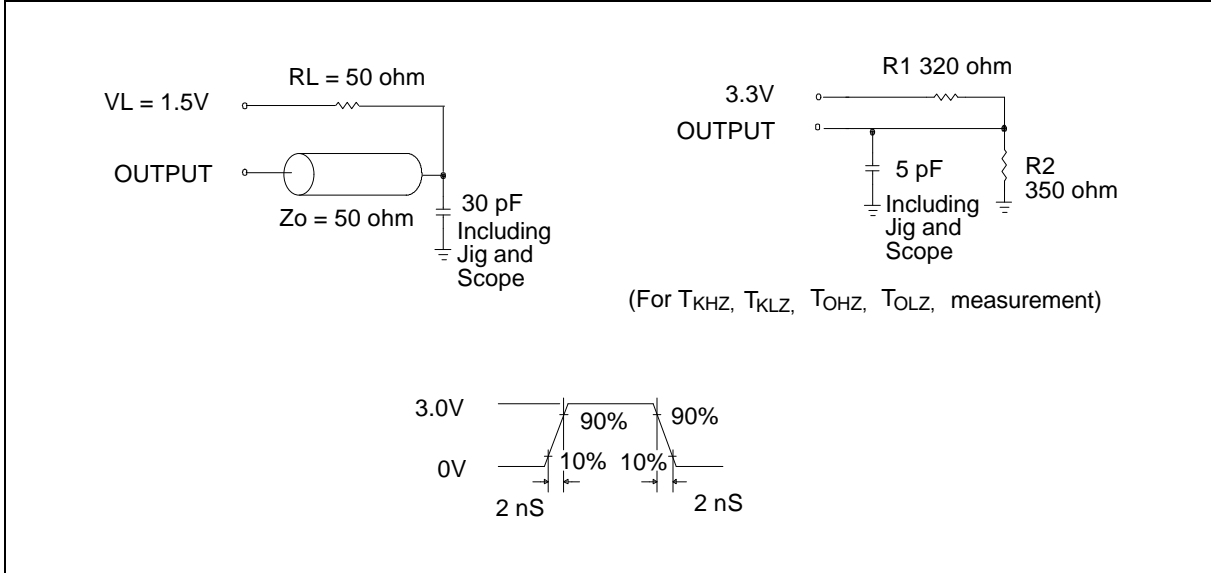

## AC TIMING CHARACTERISTICS

( $V_{DD}/V_{DDQ} = 3.15V$  to  $3.6V$ ,  $V_{SS}/V_{SSQ} = 0V$ ,  $T_A = 0$  to  $70^\circ C$ , all timings measured in pipelined mode)

PARAMETER	SYM.	W25P222A-4		W25P222A-4A		UNIT	NOTES
		MIN.	MAX.	MIN.	MAX.		
Add. Setup Time	$T_{AS}$	2.0	-	2.0	-	nS	
Add. Hold Time	$T_{AH}$	1.0	-	1.0	-	nS	
Write Data Setup Time	$T_{DS}$	2.0	-	2.0	-	nS	
Write Data Hold Time	$T_{DH}$	1.0	-	1.0	-	nS	
$\overline{ADV}$ Setup Time	$T_{ADVS}$	2.0	-	2.0	-	nS	
$\overline{ADV}$ Hold Time	$T_{ADVH}$	1.0	-	1.0	-	nS	
$\overline{ADSP}$ Setup Time	$T_{ADSS}$	2.0	-	2.0	-	nS	
$\overline{ADSP}$ Hold Time	$T_{ADSH}$	1.0	-	1.0	-	nS	
$\overline{ADSC}$ Setup Time	$T_{ADCS}$	2.0	-	2.0	-	nS	
$\overline{ADSC}$ Hold Time	$T_{ADCH}$	1.0	-	1.0	-	nS	
$\overline{CE1}$ , $\overline{CE2}$ , $\overline{CE3}$ Setup Time	$T_{CES}$	2.0	-	2.0	-	nS	
$\overline{CE1}$ , $\overline{CE2}$ , $\overline{CE3}$ Hold Time	$T_{CEH}$	1.0	-	1.0	-	nS	
$\overline{GW}$ , $\overline{BWE}$ X Setup Time	$T_{WS}$	2.0	-	2.0	-	nS	
$\overline{GW}$ , $\overline{BWE}$ X Hold Time	$T_{WH}$	1.0	-	1.0	-	nS	



# Preliminary W25P222A



## AC Timing Characteristics, continued

PARAMETER	SYM.	W25P222A-4		W25P222A-4A		UNIT	NOTES
		MIN.	MAX.	MIN.	MAX.		
Clock Cycle Time	TCYC	7.5	-	10	-	nS	
Clock High Pulsh Width	TKH	3.0	-	4	-	nS	
Clock Low Pulse Width	TKL	3.0	-	4	-	nS	
Clock to Output Valid	TKQ	-	4	-	4.5	nS	
Clock to Output High-Z	TKHZ	1.5	7.5	1.5	10	nS	1
Clock to Output Low-Z	TKLZ	0	-	0	-	nS	1
Clock to Output Invalid	TKX	1.5	-	1.5	-	nS	1
Output Enable to Output Valid	TOE	-	4	-	4.5	nS	
Output Enable to Output High-Z	TOHZ	-	4	-	4.5	nS	1
Output Enable to Output Low-Z	TOLZ	0	-	0	-	nS	1
Output Enable to Output Invalid	TOX	0	-	0	-	nS	
ZZ Standby Time	TZZS	-	100	-	100	nS	2
ZZ Recover Time	TZZR	100	-	100	-	nS	3

### Notes:

1. These parameters are sampled but not 100% tested
2. In the ZZ mode, the SRAM will enter a low-power state. In this mode, data retention is guaranteed and the clock is active.
3.  $\overline{\text{ADSC}}$  and  $\overline{\text{ADSP}}$  should not be accessed for at least 100 nS after chip leaves ZZ mode.
4. Configuration signals  $\overline{\text{LBO}}$  and  $\overline{\text{FT}}$  are static and should not be changed during operation.



## TIMING WAVEFORMS

### Read Cycle Timing

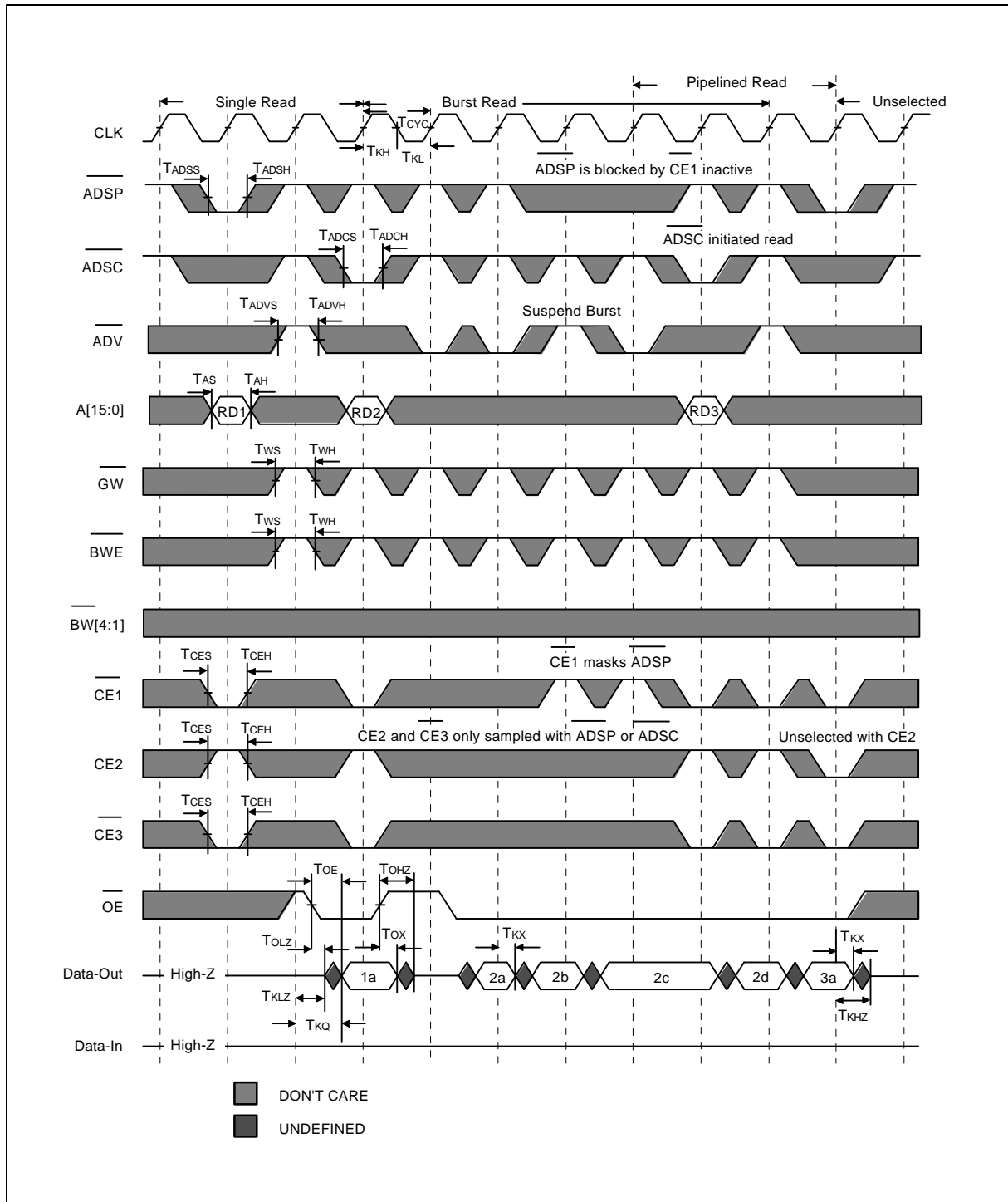



Timing Waveforms, continued

## Write Cycle Timing

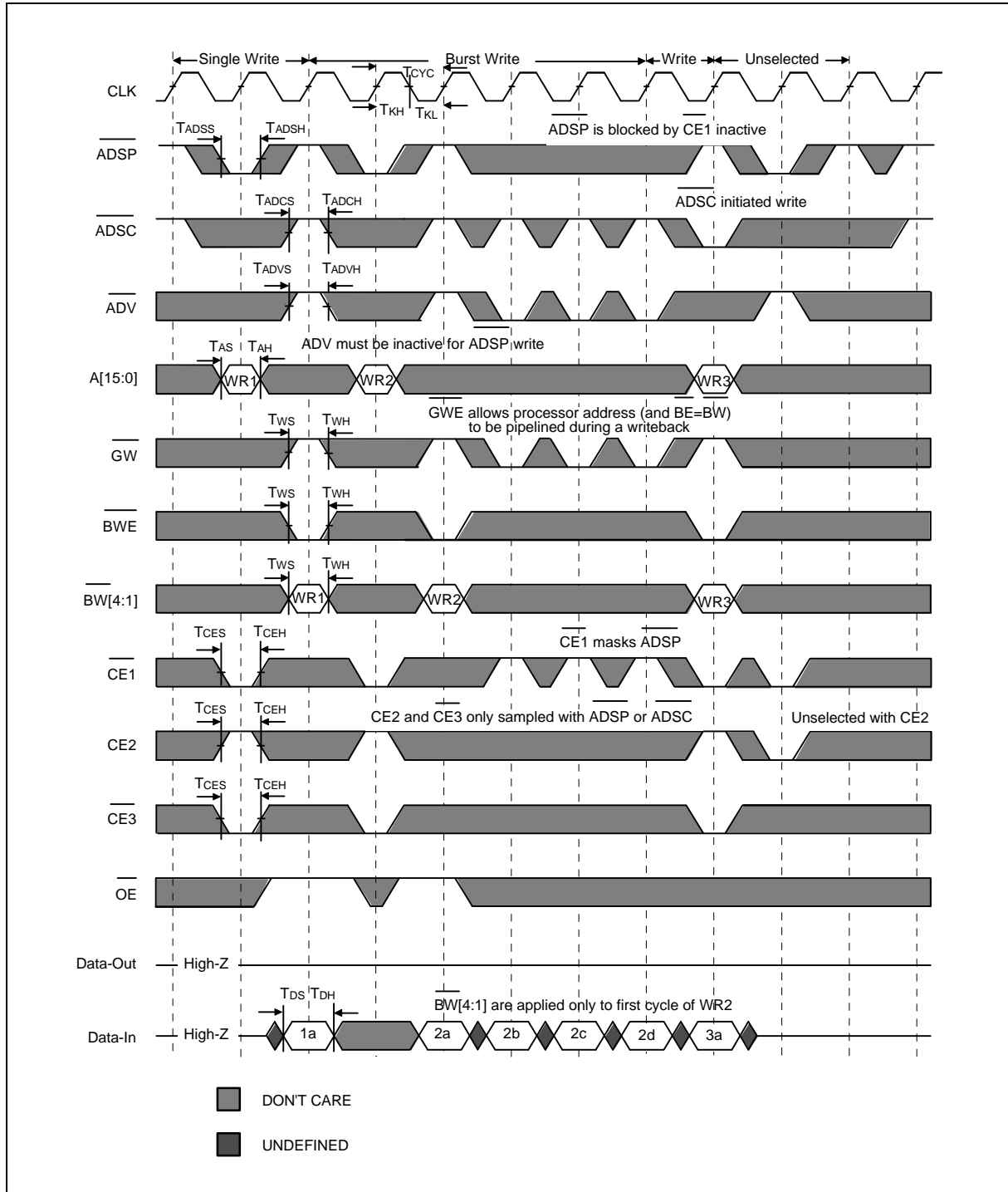



Timing Waveforms, continued

## Read/Write Cycle Timing

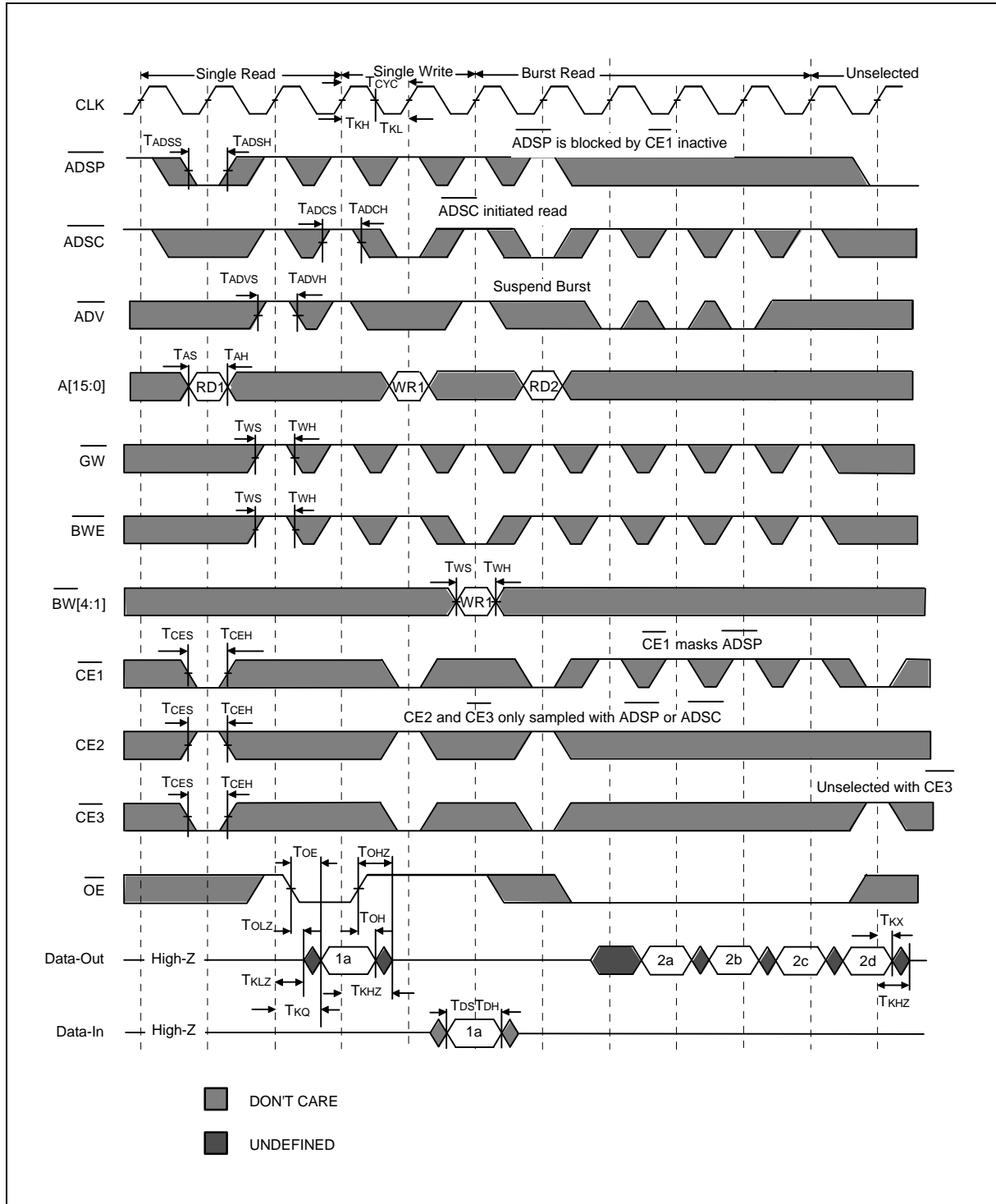

# Preliminary W25P222A



Timing Waveforms, continued

## ZZ and RD Timing

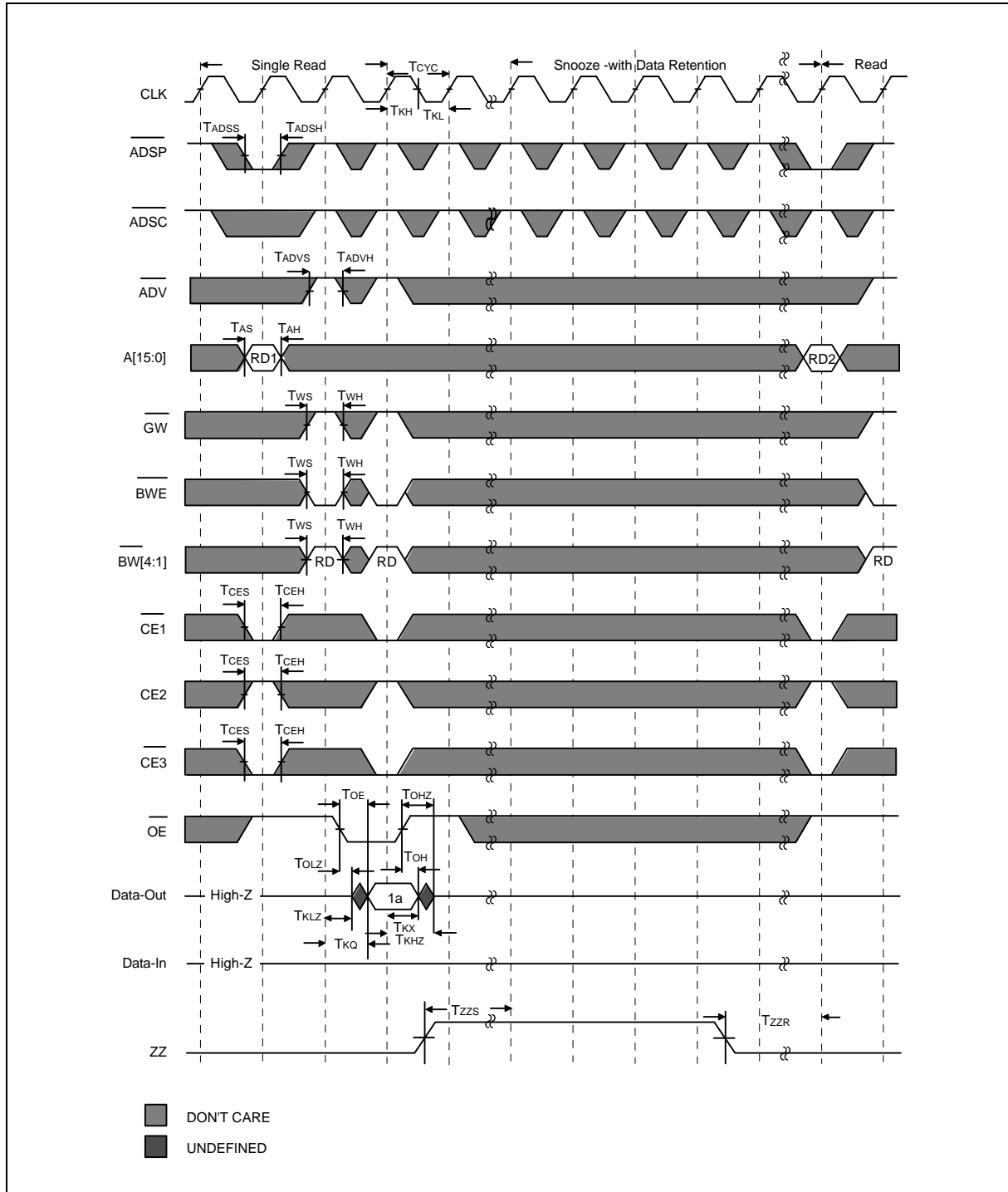



Timing Waveforms, continued

## Dual-bank Burst Read Cycle

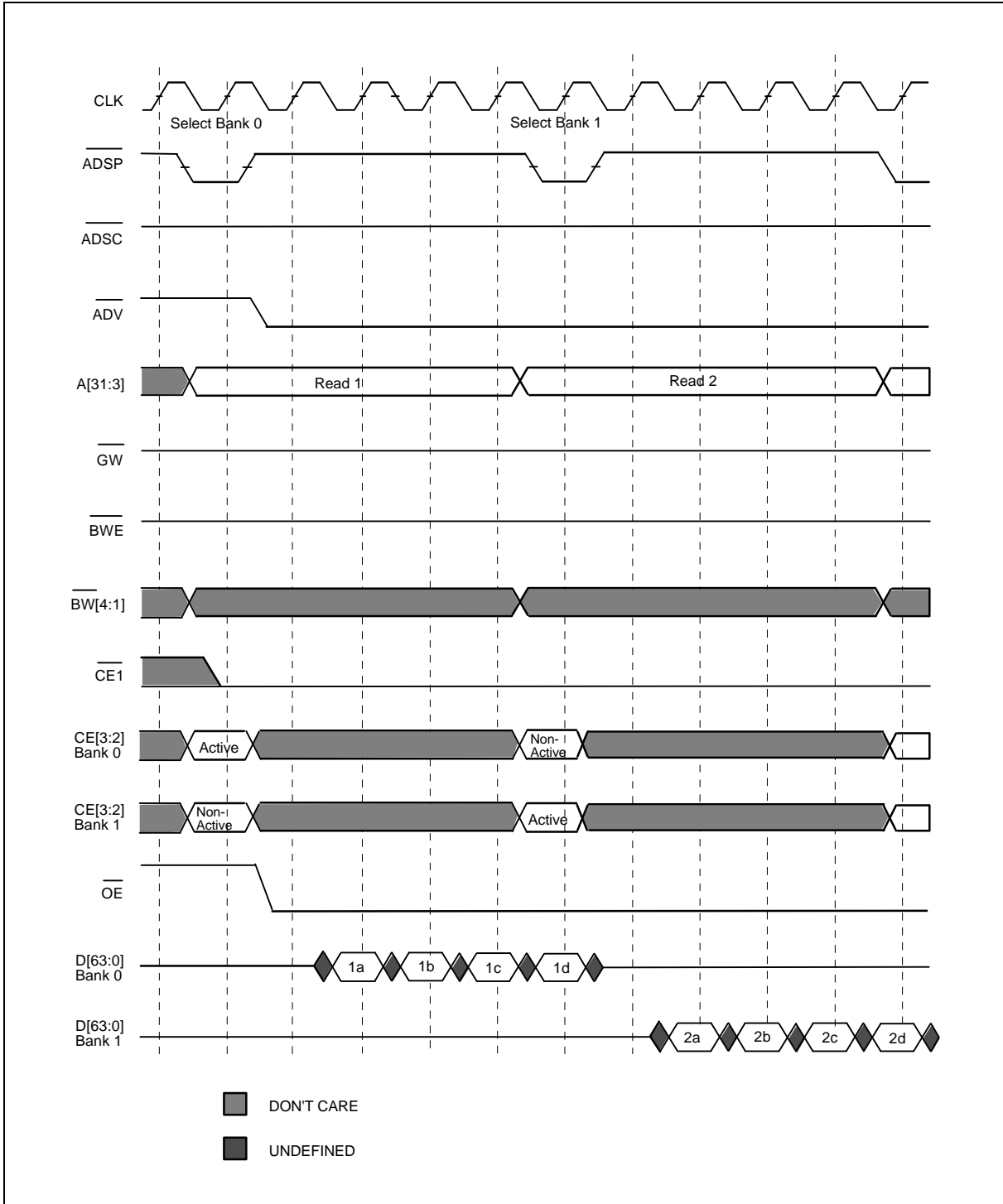

# Preliminary W25P222A



## ORDERING INFORMATION

PART NO.	ACCESS TIME (nS)	OPERATING CURRENT MAX. (mA)	STANDBY CURRENT MAX. (mA)	PACKAGE
W25P222AF-4	4	250	80	100-pin QFP
W25P222AF-4A	4.5	250	80	100-pin QFP
W25P222AD-4	4	250	80	100-pin TQFP
W25P222AD-4A	4.5	250	80	100-pin TQFP

Notes:

1. Winbond reserves the right to make changes to its products without prior notice.
2. Purchasers are responsible for performing appropriate quality assurance testing on products intended for use in applications where personal injury might occur as a consequence of product failure.

# Preliminary W25P222A



## PACKAGE DIMENSIONS

### 100-pin QFP

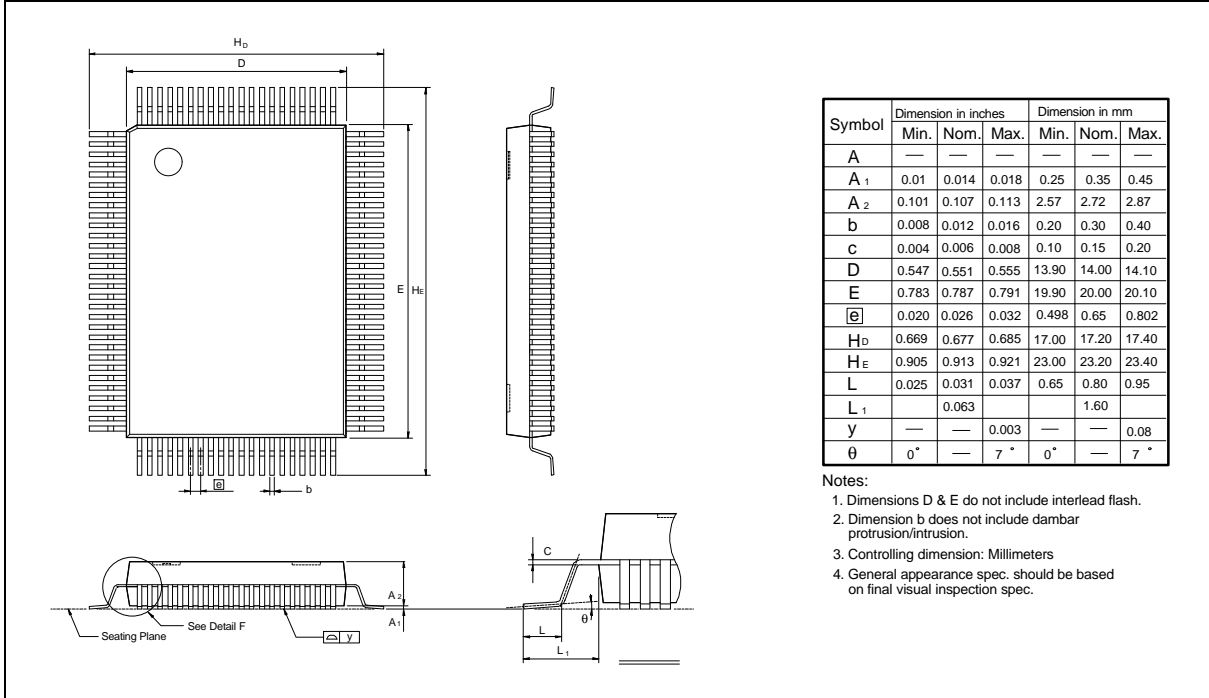

### 100-pin TQFP

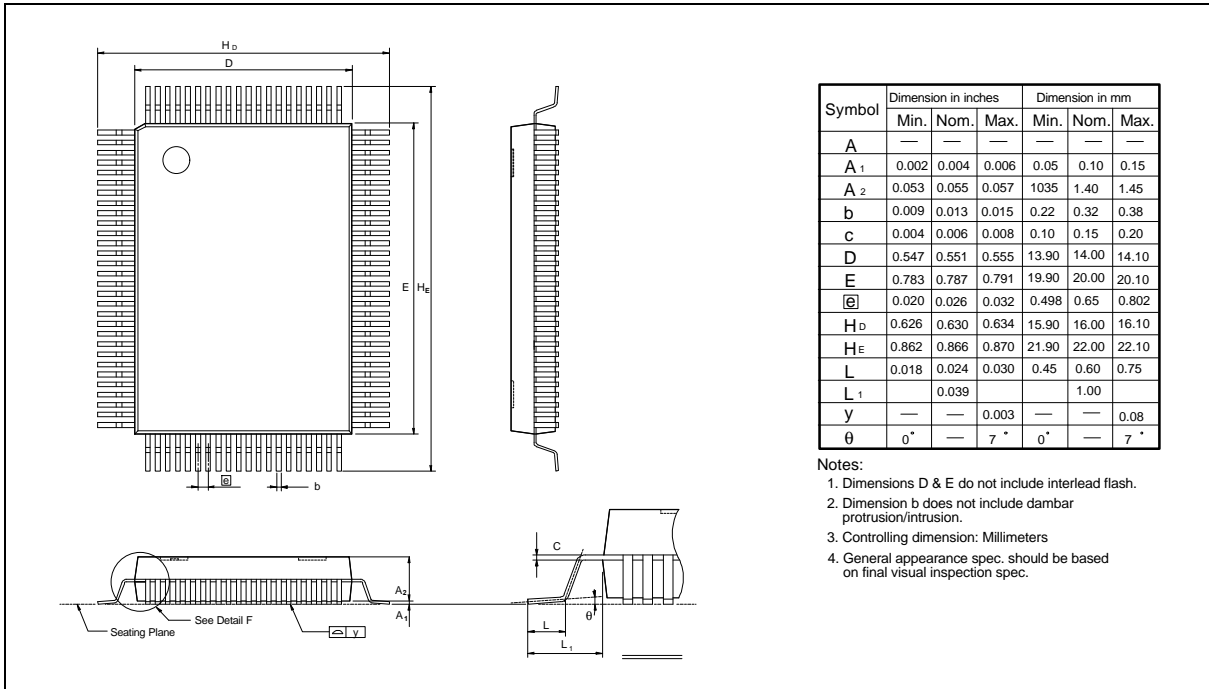



# Preliminary W25P222A



#### **Headquarters**

No. 4, Creation Rd. III,  
Science-Based Industrial Park,  
Hsinchu, Taiwan  
TEL: 886-3-5770066  
FAX: 886-3-5792647  
<http://www.winbond.com.tw/>  
Voice & Fax-on-demand: 886-2-7197006

#### **Taipei Office**

11F, No. 115, Sec. 3, Min-Sheng East Rd.,  
Taipei, Taiwan  
TEL: 886-2-7190505  
FAX: 886-2-7197502

#### **Winbond Electronics (H.K.) Ltd.**

Rm. 803, World Trade Square, Tower II,  
123 Hoi Bun Rd., Kwun Tong,  
Kowloon, Hong Kong  
TEL: 852-27513100  
FAX: 852-27552064

#### **Winbond Electronics North America Corp.**

**Winbond Memory Lab.**  
**Winbond Microelectronics Corp.**  
**Winbond Systems Lab.**  
2727 N. First Street, San Jose,  
CA 95134, U.S.A.  
TEL: 1-408-9436666  
FAX: 1-408-5441798

Note: All data and specifications are subject to change without notice.