

Analogue Reference

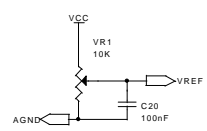

RS232 Circuit

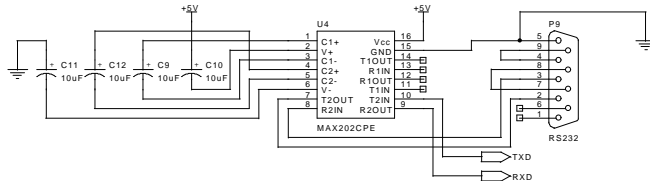

Lights and Switches

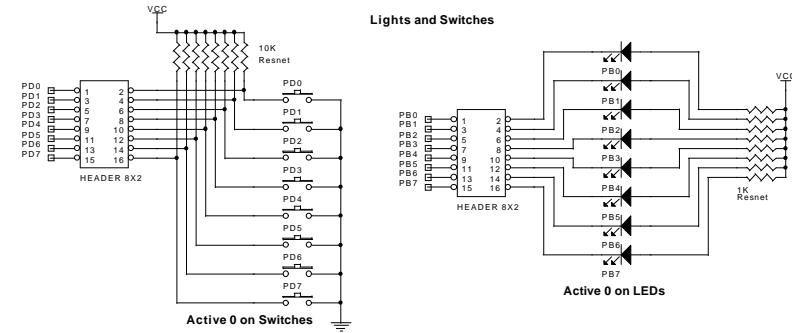

LCD Timing Circuit

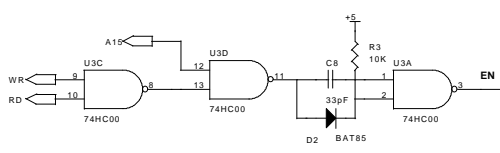

LCD Interface

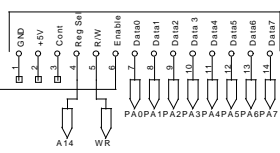

Interface Connection

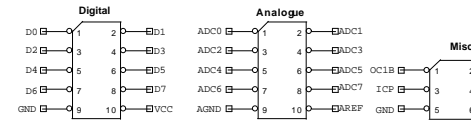

Brownout Detector Circuit

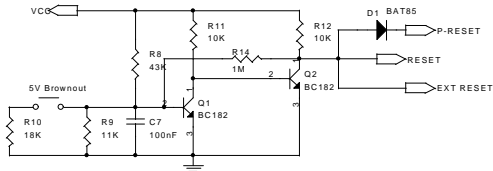

Decoupling Capacitors

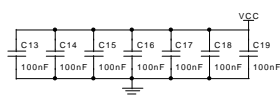

Clock Generation Circuit

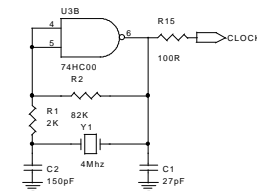

External RAM Connection

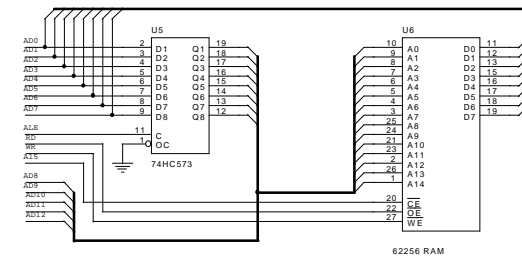

Programming Interface

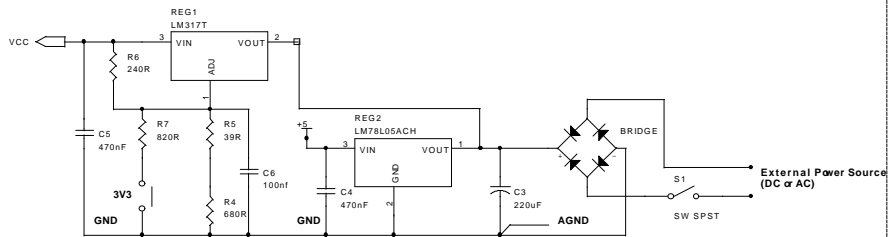
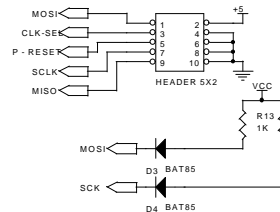

(C) 1998 Kanda Systems

File	Avr Starter Kit (Support Circuits)	
Size	Document Number	Rev
C	KA-ANA-ST1	1.0
Date:	Friday, August 14, 1998	Sheet 1 of 1