

# W91510N SERIES



## TONE/PULSE DIALER WITH HANDFREE AND SAVE FUNCTIONS

### GENERAL DESCRIPTION

The W91510N series are Si-gate CMOS ICs that provide the necessary signals for tone or pulse dialing. The W91510N series provide one-key redial, handfree dialing, key tone, save, and redial functions.

### FEATURES

- DTMF/pulse switchable dialer
- Two by 32-digit redial and save memory
- Pulse-to-tone (\*T) keypad for long distance call operation
- Uses 5 × 4 keyboard
- Easy operation with redial, flash, pause, and \*T keypads
- Pause, pulse-to-tone (\*T) can be stored as a digit in memory
- On-hook debounce time: 150 mS
- Dialing rate (10 ppS or 20 ppS ) selectable by bonding option
- Minimum tone output duration: 93 msec.
- Minimum intertone pause: 93 msec.
- Flash break time (73, 100, 300, 600 msec.) selectable by keypad; pause time is 1.0 sec.
- On-chip power-on reset
- Uses 3.579545 MHz crystal or ceramic resonator
- Packaged in 18 or 20-pin plastic DIP
- The different dialers in the W91510N series are shown in the following table:

TYPE NO.	REPLACEMENT TYPE NO.	PULSE (ppS)	FLASH (mS)	M/B	HANDFREE DIALING	PACKAGE (PINS)
W91510N	W91510	10	600/100/300/73	Pin	-	18
W91511N	W91511	20	600/100/300/73	Pin	-	18
W91510AN	W91510A	10	600/100/300/73	Pin	Yes	20
W91511AN	W91511A	20	600/100/300/73	Pin	Yes	20

## PIN CONFIGURATIONS

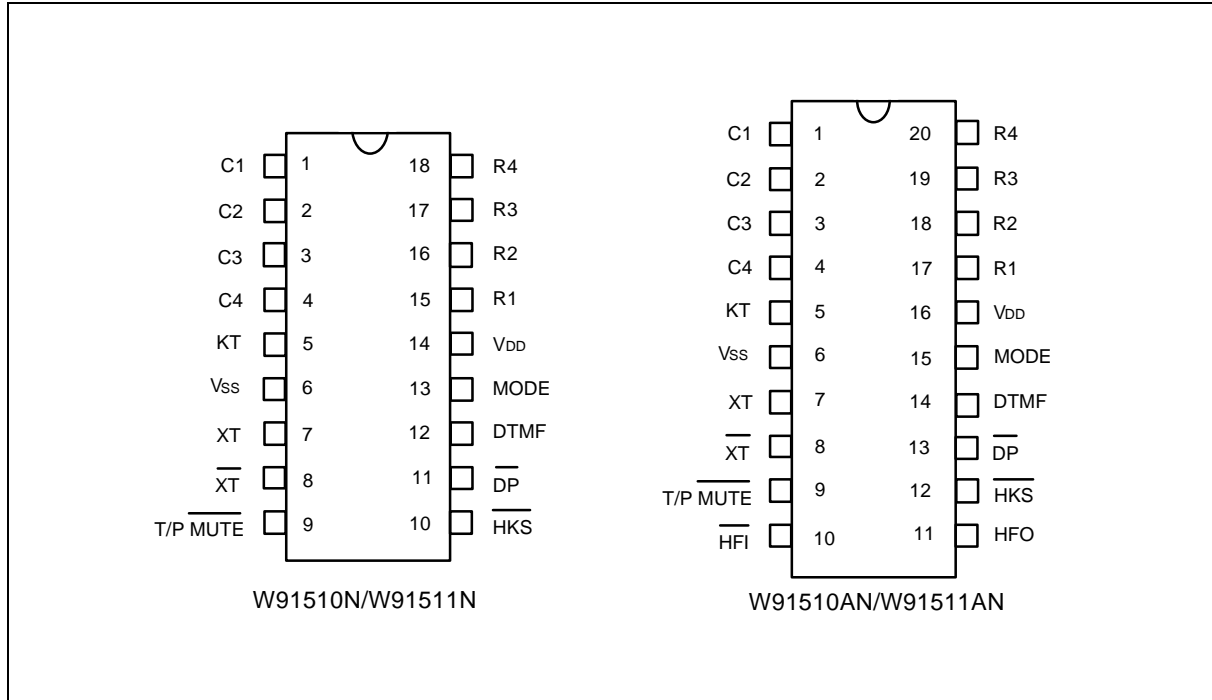

## PIN DESCRIPTION

SYMBOL	18-PIN	20-PIN	I/O	FUNCTION
Column-Row Inputs	1-4 & 15-18	1-4 & 17-20	I	The keyboard inputs may be used with either a standard 5 × 4 keyboard or an inexpensive single contact (Form A) keyboard. Electronic input from a $\mu\text{C}$ can also be used. A valid key-in is defined as a single row being connected to a single column.
XT, $\overline{\text{XT}}$	7, 8	7, 8	I, O	A built-in inverter provides oscillation with an inexpensive 3.579545 MHz crystal or ceramic resonator.
$\overline{\text{T/P MUTE}}$	9	9	O	The $\overline{\text{T/P MUTE}}$ is a conventional CMOS N-channel open drain output.  The output transistor is switched on during dialing sequence, one-key redial break, and flash break time. Otherwise, it is switched off.

# W91510N SERIES



Pin Description, continued

SYMBOL	18-PIN	20-PIN	I/O	FUNCTION																																				
MODE	13	15	I	<p>Pulling mode pin to VSS places the dialer in tone mode.</p> <p>Pulling mode pin to VDD places the dialer in pulse mode (10 ppS; 20 ppS for W91511N/511AN, M/B = 40:60).</p> <p>Floating mode pin places the dialer in pulse mode (10 ppS; 20 ppS for W91511N/511AN, M/B = 33.3:66.7).</p>																																				
$\overline{\text{HKS}}$	10	12	I	<p>Hook switch input.</p> <p><math>\overline{\text{HKS}} = \text{VDD}</math>: On-hook state. Chip in sleeping mode, no operation.</p> <p><math>\overline{\text{HKS}} = \text{VSS}</math>: Off-hook state. Chip is enabled for normal operation.</p> <p><math>\overline{\text{HKS}}</math> pin is pulled to VDD by an internal resistor.</p>																																				
$\overline{\text{DP}}$	11	13	O	<p>N-channel open drain dialing pulse output.</p> <p>Flash key will cause <math>\overline{\text{DP}}</math> to be active in either tone mode or pulse mode.</p> <p>The timing diagram for pulse mode is shown in Figure 1(a, b, c).</p>																																				
VDD, VSS	14, 6	16, 6	I	Power input pins.																																				
KT	5	5	O	Key-tone signal output. The key tone is generated for all valid keys. Frequency is 600 Hz and duration is 35 mS.																																				
DTMF	12	14	O	<p>In pulse mode, this pin remains in low state at all times.</p> <p>In tone mode, it will output a dual or single tone.</p> <p>Detailed timing diagram for tone mode is shown in Figure 2(a, b, c).</p> <table border="1" data-bbox="755 1339 1203 1743"> <thead> <tr> <th colspan="4">Output Frequency</th> </tr> <tr> <th></th> <th>Specified</th> <th>Actual</th> <th>Error %</th> </tr> </thead> <tbody> <tr> <td>R1</td> <td>697</td> <td>699</td> <td>+0.28</td> </tr> <tr> <td>R2</td> <td>770</td> <td>766</td> <td>-0.52</td> </tr> <tr> <td>R3</td> <td>852</td> <td>848</td> <td>-0.47</td> </tr> <tr> <td>R4</td> <td>941</td> <td>948</td> <td>+0.74</td> </tr> <tr> <td>C1</td> <td>1209</td> <td>1216</td> <td>+0.57</td> </tr> <tr> <td>C2</td> <td>1336</td> <td>1332</td> <td>-0.30</td> </tr> <tr> <td>C3</td> <td>1477</td> <td>1472</td> <td>-0.34</td> </tr> </tbody> </table>	Output Frequency					Specified	Actual	Error %	R1	697	699	+0.28	R2	770	766	-0.52	R3	852	848	-0.47	R4	941	948	+0.74	C1	1209	1216	+0.57	C2	1336	1332	-0.30	C3	1477	1472	-0.34
Output Frequency																																								
	Specified	Actual	Error %																																					
R1	697	699	+0.28																																					
R2	770	766	-0.52																																					
R3	852	848	-0.47																																					
R4	941	948	+0.74																																					
C1	1209	1216	+0.57																																					
C2	1336	1332	-0.30																																					
C3	1477	1472	-0.34																																					

# W91510N SERIES



Pin Description, continued

SYMBOL	18-PIN	20-PIN	I/O	FUNCTION																																								
$\overline{\text{HFI}}$ , HFO	-	10, 11	I, O	<p>Handfree control pins. The handfree control state is toggled on by a low pulse on the <math>\overline{\text{HFI}}</math> input pin. The status of the handfree control state is described in the following table:</p> <table border="1"> <thead> <tr> <th colspan="2">CURRENT STATE</th> <th colspan="3">NEXT STATE</th> </tr> <tr> <th>Hook SW.</th> <th>HFO</th> <th>Input</th> <th>HFO</th> <th>Dialing</th> </tr> </thead> <tbody> <tr> <td>-</td> <td>Low</td> <td><math>\overline{\text{HFI}}</math> </td> <td>High</td> <td>Yes</td> </tr> <tr> <td>On Hook</td> <td>High</td> <td><math>\overline{\text{HFI}}</math> </td> <td>Low</td> <td>No</td> </tr> <tr> <td>Off Hook</td> <td>High</td> <td><math>\overline{\text{HFI}}</math> </td> <td>Low</td> <td>Yes</td> </tr> <tr> <td>On Hook</td> <td>-</td> <td>Off Hook</td> <td>Low</td> <td>Yes</td> </tr> <tr> <td>Off Hook</td> <td>Low</td> <td>On Hook</td> <td>Low</td> <td>No</td> </tr> <tr> <td>Off Hook</td> <td>High</td> <td>On Hook</td> <td>High</td> <td>Yes</td> </tr> </tbody> </table> <p><math>\overline{\text{HFI}}</math> pin is pulled to VDD by an internal resistor. Detailed timing diagrams are shown in Figure 3.</p>	CURRENT STATE		NEXT STATE			Hook SW.	HFO	Input	HFO	Dialing	-	Low	$\overline{\text{HFI}}$	High	Yes	On Hook	High	$\overline{\text{HFI}}$	Low	No	Off Hook	High	$\overline{\text{HFI}}$	Low	Yes	On Hook	-	Off Hook	Low	Yes	Off Hook	Low	On Hook	Low	No	Off Hook	High	On Hook	High	Yes
CURRENT STATE		NEXT STATE																																										
Hook SW.	HFO	Input	HFO	Dialing																																								
-	Low	$\overline{\text{HFI}}$	High	Yes																																								
On Hook	High	$\overline{\text{HFI}}$	Low	No																																								
Off Hook	High	$\overline{\text{HFI}}$	Low	Yes																																								
On Hook	-	Off Hook	Low	Yes																																								
Off Hook	Low	On Hook	Low	No																																								
Off Hook	High	On Hook	High	Yes																																								

## BLOCK DIAGRAM

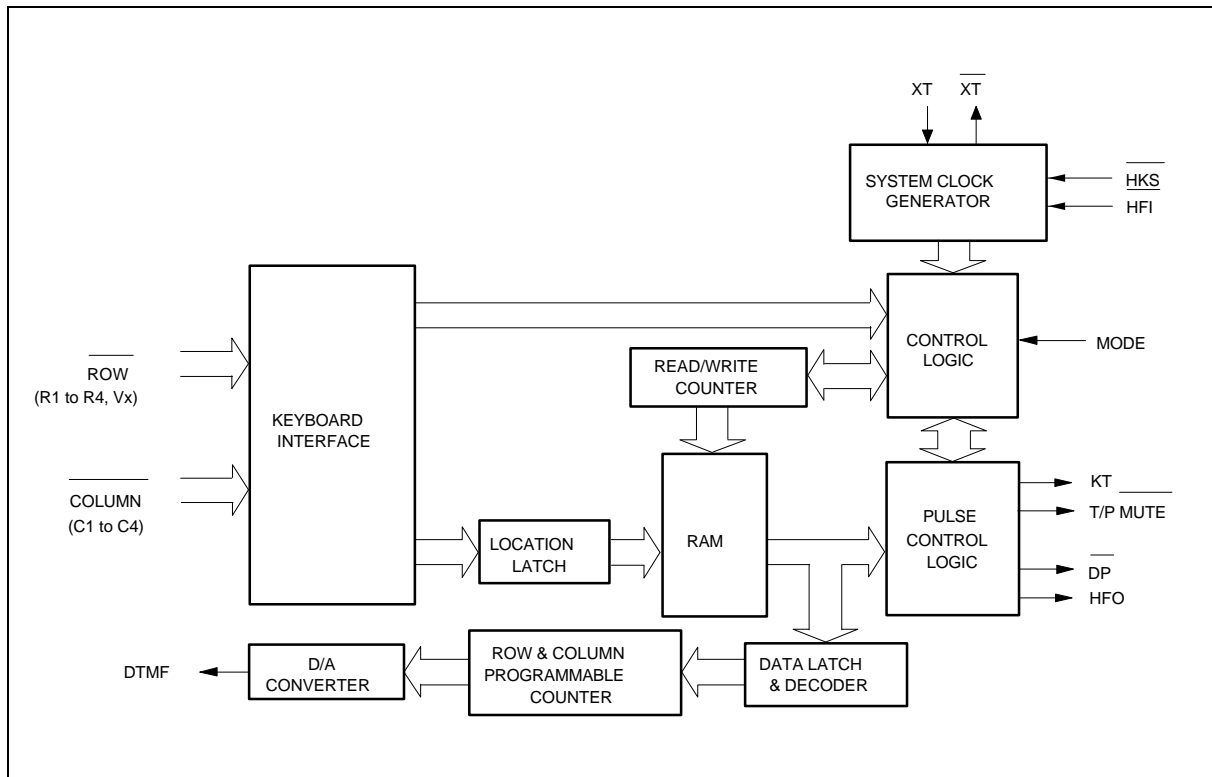



## FUNCTIONAL DESCRIPTION

### Keyboard Operation

C1	C2	C3	C4	
1	2	3	SAVE	R1
4	5	6	F1	R2
7	8	9	F2	R3
*/T	0	#	R/P1	R4
R/P2	R	F3	F4	Vx

- R/P1, R/P2: Redial and pause function key; P1 is 3.6 sec. and P2 is 2.0 sec.
- \*/T: \* in tone mode and P→T in pulse mode
- F1, ..., F4: Flash keys, flash break time of F1 = 600 mS, F2 = 100 mS, F3 = 300 mS, F4 = 73 mS
- SAVE: Save function key
- R: One-key redial function

Notes:

D1, ..., Dn, D1', ..., Dn': 0, ..., 9, \*/T, #

R/P: R/P1 or R/P2.

Fn: F1, ..., F4

### Normal Dialing

[OFF HOOK] (or [ON HOOK] &  $\overline{\text{HF1}} \overline{\text{i0}}$ ), [D1], [D2], ..., [Dn]

1. D1, D2, ..., Dn will be dialed out.
2. Dialing length is unlimited, but redial is inhibited if length exceeds 32 digits in normal dialing.

### Redialing

1. [OFF HOOK] (or [ON HOOK] &  $\overline{\text{HF1}} \overline{\text{i0}}$ ), [D1], [D2], ..., [Dn], Busy,

Come [ON HOOK], [OFF HOOK] (or [ON HOOK] &  $\overline{\text{HF1}} \overline{\text{i0}}$ ), [R/P]

- a. The redial memory content will be dialed out.
- b. The [R/P] key can execute the redial function only as the first key-in after off-hook; otherwise, it executes pause function.
- c. If redialing length exceeds 32 digits, the redialing function will be inhibited.

2. [OFF HOOK] (or [ON HOOK] &  $\overline{\text{HF1}} \overline{\text{i0}}$ ), [D1], [D2], ..., [Dn], Busy, [R]

- a. The one-key redialing function timing diagram is shown in Figure 4.



- b. If the dialing of  $\boxed{D1}$  to  $\boxed{Dn}$  is finished, pressing the  $\boxed{R}$  key will cause the pulse output pin to go low for 2.2 seconds break time and 0.6 seconds pause time will automatically be added.
- c. If the pulses of the dialed digits  $\boxed{D1}$  to  $\boxed{Dn}$  have not finished,  $\boxed{R}$  will be ignored.
- d. The redial function by  $\boxed{R}$  key has no break time (2.2 sec.) if it is the first key-in after off-hook.
- e. The  $\boxed{R}$  key uses the same redial buffer as the redial function by  $\boxed{R/P1}$  or  $\boxed{R/P2}$  key, the and it is active during normal dialing or repertory dialing.

### Access Pause

$\boxed{\text{OFF HOOK}}$  (or  $\boxed{\text{ON HOOK}}$  &  $\boxed{\overline{\text{HF1}} \ \overline{\text{i0}}}$ ),  $\boxed{D1}$ ,  $\boxed{D2}$ ,  $\boxed{R/P}$ ,  $\boxed{D3}$ , ...,  $\boxed{Dn}$

1. The pause function is executed in normal dialing, redial dialing, or memory dialing.
2. The pause duration of 2.0 or 3.6 seconds per pause is selected by keypad, but only one pause time can be stored in memory.
3. A detailed timing diagram for the pause function is shown in Figure 5.

### Pulse-to-tone (\*T)

$\boxed{\text{OFF HOOK}}$  (or  $\boxed{\text{ON HOOK}}$  &  $\boxed{\overline{\text{HF1}} \ \overline{\text{i0}}}$ ),  $\boxed{D1}$ ,  $\boxed{D2}$ , ...,  $\boxed{Dn}$ ,  $\boxed{*/T}$ ,  $\boxed{D1'}$ ,  $\boxed{D2'}$ , ...,  $\boxed{Dn'}$

1. If the mode switch is set to pulse mode, then the output signal will be:  
 $D1, D2, \dots, Dn, \text{Pause (2.0 sec. or 3.6 sec.), } D1', D2', \dots, Dn'$   
 (Pulse) (Tone)
2. If the mode switch is set to tone mode, then the output signal will be:  
 $D1, D2, \dots, Dn, *, D1', D2', \dots, Dn'$   
 (Tone) (Tone)
3. The dialer remains in tone mode when the digits have been dialed out and can be reset to pulse mode only by going on-hook.
4. The pulse-to-tone function timing diagram is shown in Figure 6.

### Save

$\boxed{\text{OFF HOOK}}$  (or  $\boxed{\text{ON HOOK}}$  &  $\boxed{\overline{\text{HF1}} \ \overline{\text{i0}}}$ ),  $\boxed{D1}$ ,  $\boxed{D2}$ , ...,  $\boxed{Dn}$ ,  $\boxed{\text{SAVE}}$

- a.  $D1, D2, \dots, Dn$  will be dialed out.
- b. If the sequence of the dialed digits  $D1, D2, \dots, Dn$  has not finished,  $\boxed{\text{SAVE}}$  will be ignored;

otherwise, D1, D2, ..., Dn will be duplicated to the save memory.

## Flash

OFF HOOK (or ON HOOK &  $\overline{\text{HF}}\overline{\text{I}}\overline{\text{O}}$  ), Fn

1. Fn = F1, ..., F4
2. The dialer will execute a flash break time of 600 mS (F1), 100 mS (F2), 300 mS (F3), or 73 mS (F4). In each case, the flash pause time is 1.0 sec. before the next digit is dialed out.
3. Flash key cannot be stored as a digit in memory. The flash key has first priority among keyboard functions.
4. The system will return to the initial state after the flash pause time is finished.
5. The flash function timing diagram is shown in Figure 7.

## ABSOLUTE MAXIMUM RATINGS

PARAMETER	SYMBOL	RATING	UNIT
DC Supply Voltage	V <sub>DD</sub> -V <sub>SS</sub>	-0.3 to +7.0	V
Input/Output Voltage	V <sub>IL</sub>	V <sub>SS</sub> -0.3	V
	V <sub>IH</sub>	V <sub>DD</sub> +0.3	V
	V <sub>OL</sub>	V <sub>SS</sub> -0.3	V
	V <sub>OH</sub>	V <sub>DD</sub> +0.3	V
Power Dissipation	P <sub>D</sub>	120	mW
Operation Temperature	T <sub>OPR</sub>	-20 to +70	°C
Storage Temperature	T <sub>STG</sub>	-55 to +150	°C

Note: Exposure to conditions beyond those listed under Absolute Maximum Ratings may adversely affect the life and reliability of the device.

# W91510N SERIES



## DC CHARACTERISTICS

(V<sub>DD</sub>-V<sub>SS</sub> = 2.5V, F<sub>osc</sub> = 3.579545 MHz, T<sub>A</sub> = 25° C, All outputs unloaded)

PARAMETER	SYMBOL	CONDITIONS	MIN.	TYP.	MAX.	UNIT
Operating Voltage	V <sub>DD</sub>	-	2.0	-	5.5	V
Operating Current	I <sub>OP</sub>	Tone, Unloaded	-	0.4	0.6	mA
		Pulse, Unloaded	-	0.2	0.4	
Standby Current	I <sub>SB</sub>	$\overline{\text{HKS}} = \text{V}_{\text{SS}}$ , No load & No key entry	-	-	15	μA
Memory Retention Current	I <sub>MR</sub>	$\overline{\text{HKS}} = \text{V}_{\text{DD}}$ , V <sub>DD</sub> = 1.0V	-	-	0.2	μA
DTMF Output Voltage	V <sub>TO</sub>	Row group, R <sub>L</sub> = 5 KΩ	130	150	170	mV <sub>rms</sub>
Pre-emphasis		Col/Row, V <sub>DD</sub> = 2.0 to 5.5V	1	2	3	dB
DTMF Distortion	THD	R <sub>L</sub> = 5 KΩ, V <sub>DD</sub> = 2.0 to 5.5V	-	-30	-23	dB
DTMF Output DC Level	V <sub>TDC</sub>	R <sub>L</sub> = 5 KΩ, V <sub>DD</sub> = 2.0 to 5.5V	1.0	-	3.0	V
DTMF Output Sink Current	I <sub>TL</sub>	V <sub>TO</sub> = 0.5V	0.2	-	-	mA
$\overline{\text{DP}}$ Output Sink Current	I <sub>PL</sub>	V <sub>PO</sub> = 0.5V	0.5	-	-	mA
T/P $\overline{\text{MUTE}}$ Output Sink Current	I <sub>TML</sub>	V <sub>TMO</sub> = 0.5V	0.5	-	-	mA
KT Drive/Sink Current	I <sub>KTH</sub>	V <sub>KTH</sub> = 2.0V	0.5	-	-	mA
	I <sub>KTL</sub>	V <sub>KTL</sub> = 0.5V	0.5	-	-	mA
HFO Drive/Sink Current	I <sub>HFH</sub>	V <sub>HFH</sub> = 2.0V	0.5	-	-	mA
	I <sub>HFL</sub>	V <sub>HFL</sub> = 0.5V	0.5	-	-	mA
Keypad Input Drive Current	I <sub>KD</sub>	V <sub>I</sub> = 0.0V	30	-	-	μA
Keypad Input Sink Current	I <sub>KS</sub>	V <sub>I</sub> = 2.5V	200	400	-	μA
$\overline{\text{HKS}}$ I/P Pull-high Resistor	R <sub>HK</sub>	-	-	300	-	KΩ
Keypad Resistance	R <sub>K</sub>	-	-	-	5	KΩ



# W91510N SERIES



## AC CHARACTERISTICS

(V<sub>DD</sub>-V<sub>SS</sub> = 2.5V, F<sub>osc</sub> = 3.579545 MHz, T<sub>A</sub> = 25° C, All outputs unloaded)

PARAMETER	SYMBOL	CONDITIONS	MIN.	TYP.	MAX.	UNIT
Key-in Debounce	TKID	-	-	20	-	mS
Key Release Debounce	TKRD	-	-	20	-	mS
On-hook Debounce	TOHD	-	-	150	-	mS
Pre-digit Pause <sup>1</sup>	TPDP1 10 ppS	Mode = V <sub>DD</sub>	-	40	-	mS
		Mode = Floating	-	33.3	-	
Pre-digit Pause <sup>2</sup>	TPDP2 20 ppS	Mode = V <sub>DD</sub>	-	20	-	mS
		Mode = Floating	-	16.7	-	
Interdigit Pause (Auto Dialing)	TIDP	10 ppS	-	800	-	mS
		20 ppS	-	500	-	
Make/Break Ratio	M:B	Mode = V <sub>DD</sub>	-	40:60	-	%
		Mode = Floating	-	33.3: 66.7	-	
Tone Output Duration	TTD	Auto dialing	-	93	-	mS
Intertone Pause	TITP	Auto dialing	-	93	-	mS
Flash Break Time	TFB	F1	-	600	-	mS
		F2	-	100	-	
		F3		300		
		F4	-	73	-	
Flash Pause Time	TFP	F1, F2, F3, F4	-	1.0	-	S
Pause Time	TP	R/P1	-	3.6	-	S
		R/P2	-	2.0	-	
Key Tone Frequency	FKT	-	-	600	-	Hz
Key Tone Duration	TKTD	-	-	35	-	mS
One-key Redial Break Time	TRB	-	-	2.2	-	S
One-key Redial Pause Time	TRP	-	-	600	-	mS

Notes:

- Crystal parameters suggested for proper operation are R<sub>s</sub> < 100 Ω, L<sub>m</sub> = 96 mH, C<sub>m</sub> = 0.02 pF, C<sub>n</sub> = 5 pF, C<sub>l</sub> = 18 pF, F<sub>osc</sub> = 3.579545 MHz ±0.02%.
- Crystal oscillator accuracy directly affects these times.

## TIMING WAVEFORMS

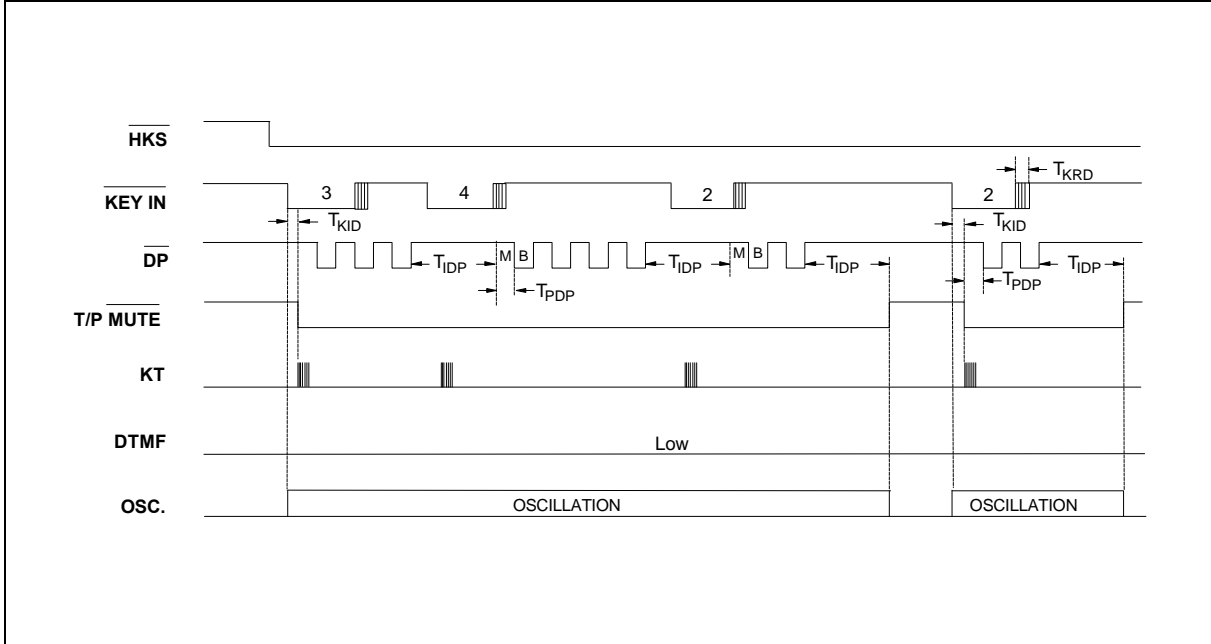

Figure 1(a) Normal Dialing Timing Diagram

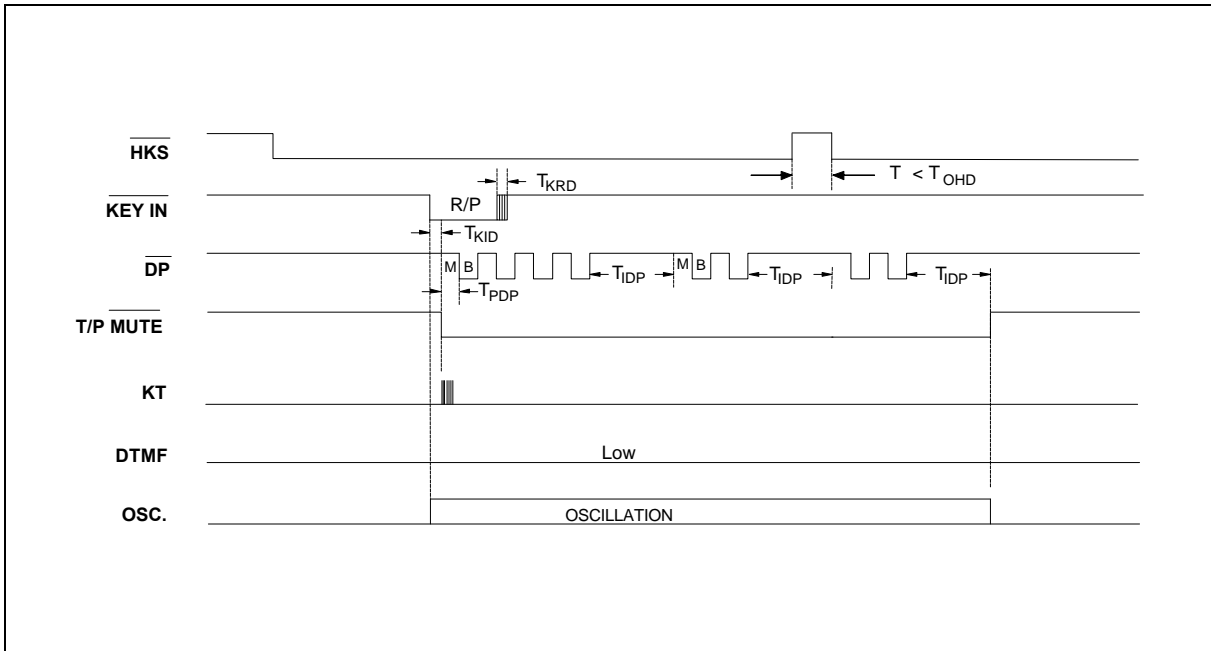

Figure 1(b) Pulse Mode Auto Dialing Timing Diagram

Timing Waveform, continued

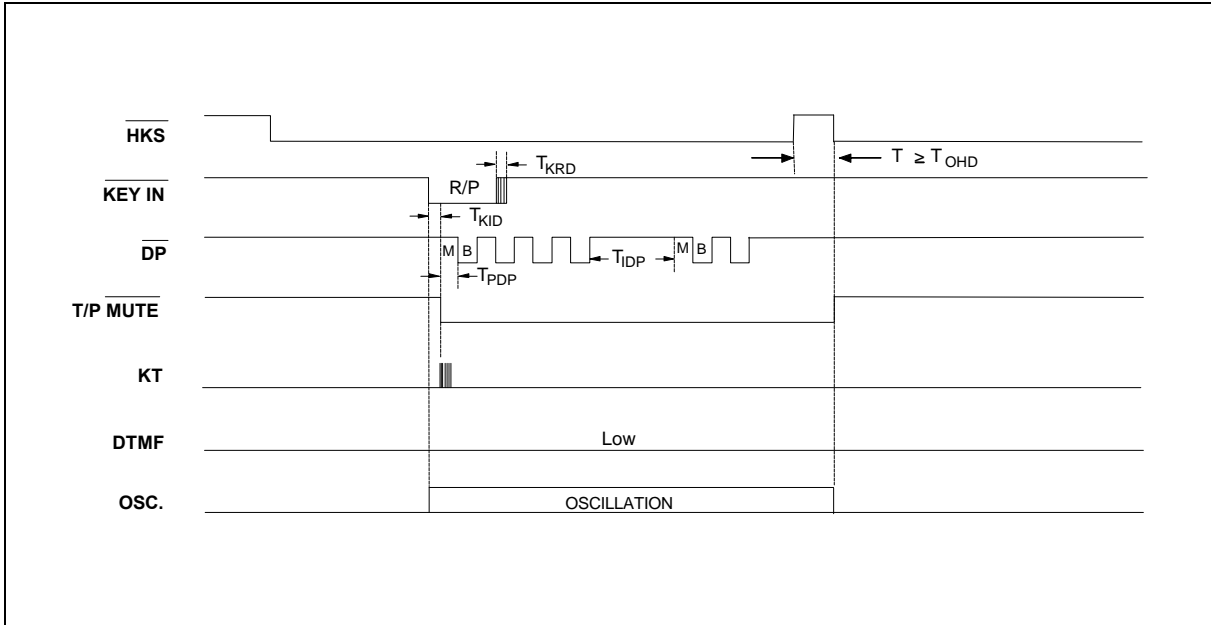

Figure 1(c) Pulse Mode Auto Dialing Timing Diagram

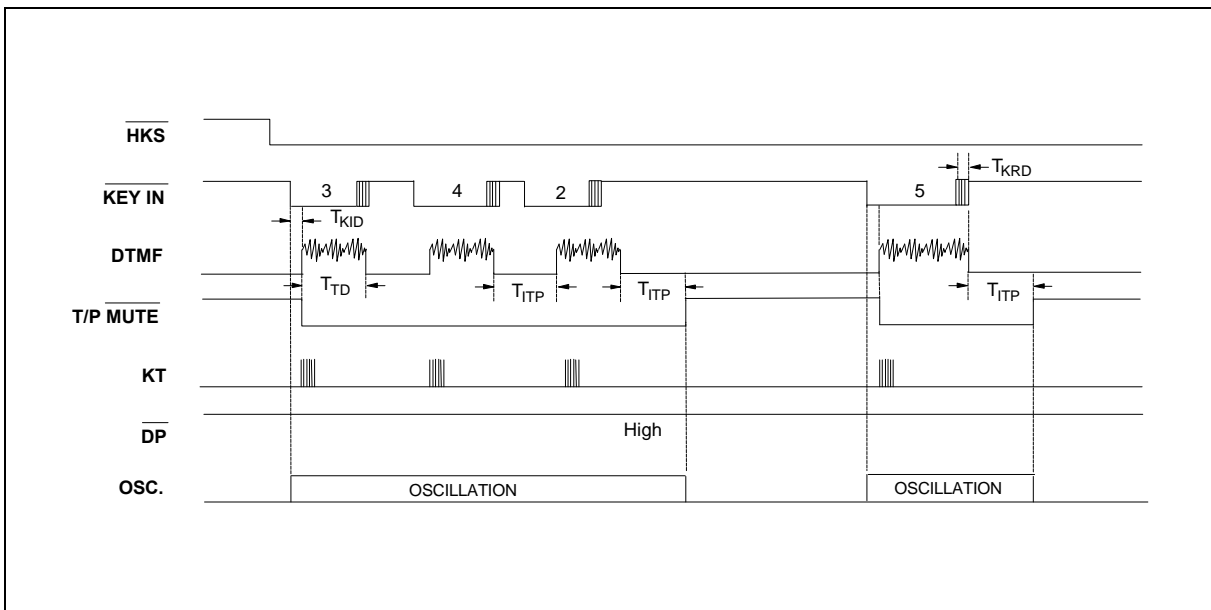

Figure 2(a) Tone Mode Normal Dialing Timing Diagram

Timing Waveform, continued

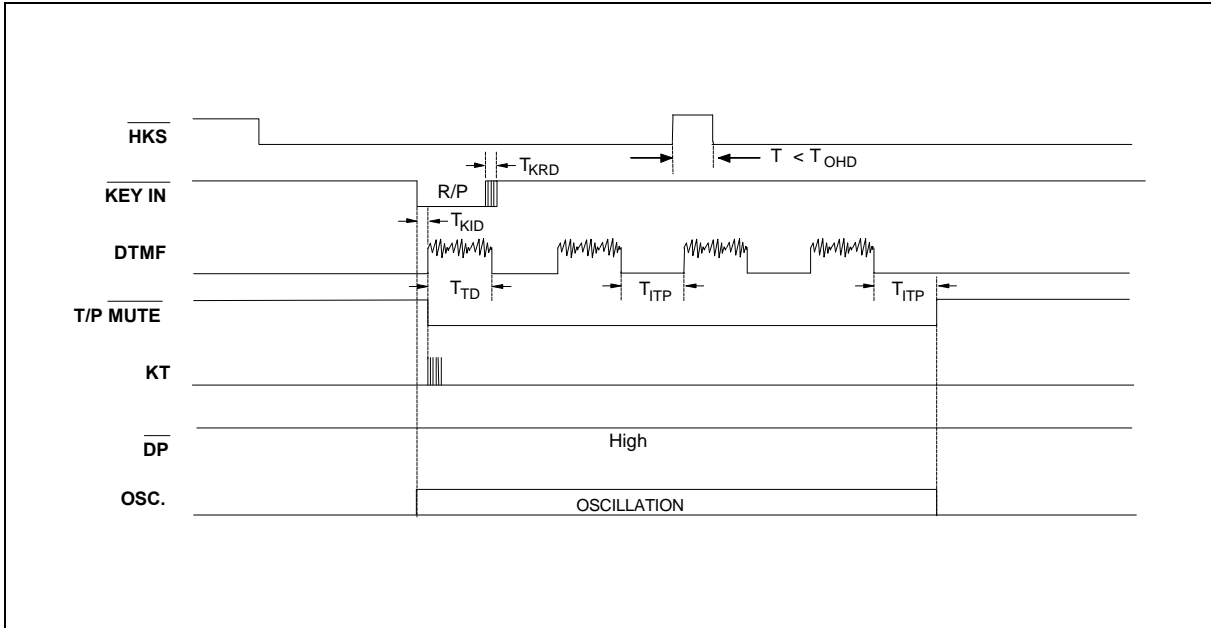

Figure 2(b) Tone Mode Auto Dialing Timing Diagram

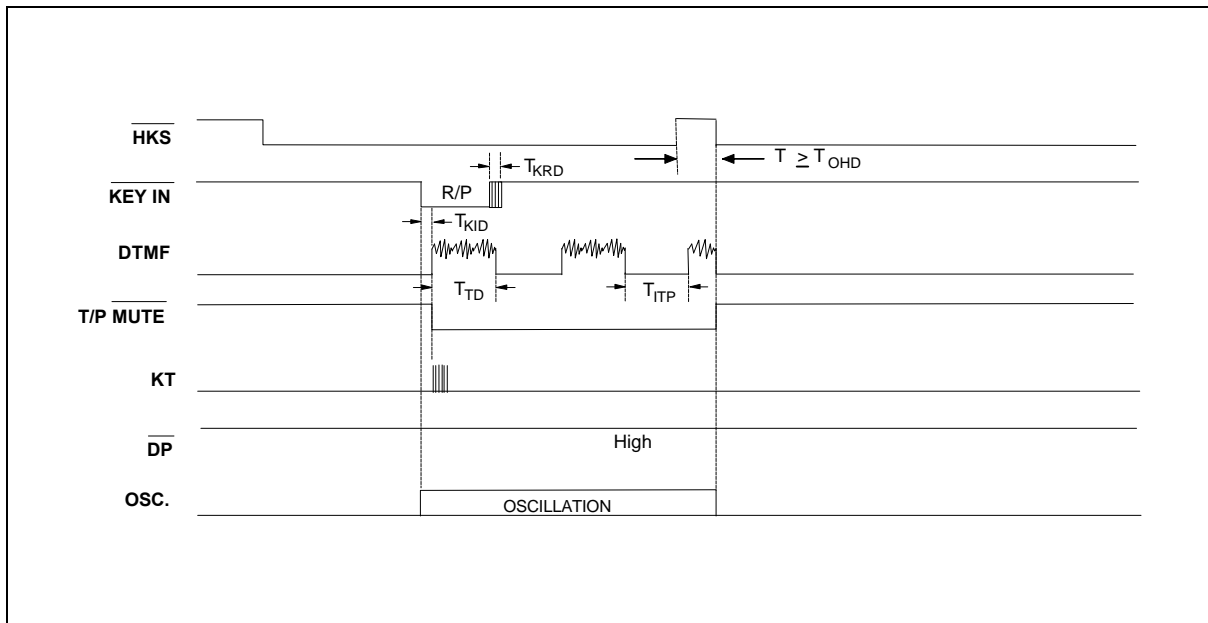

Figure 2(c) Tone Mode Auto Dialing Timing Diagram

# W91510N SERIES



Timing Waveform, continued

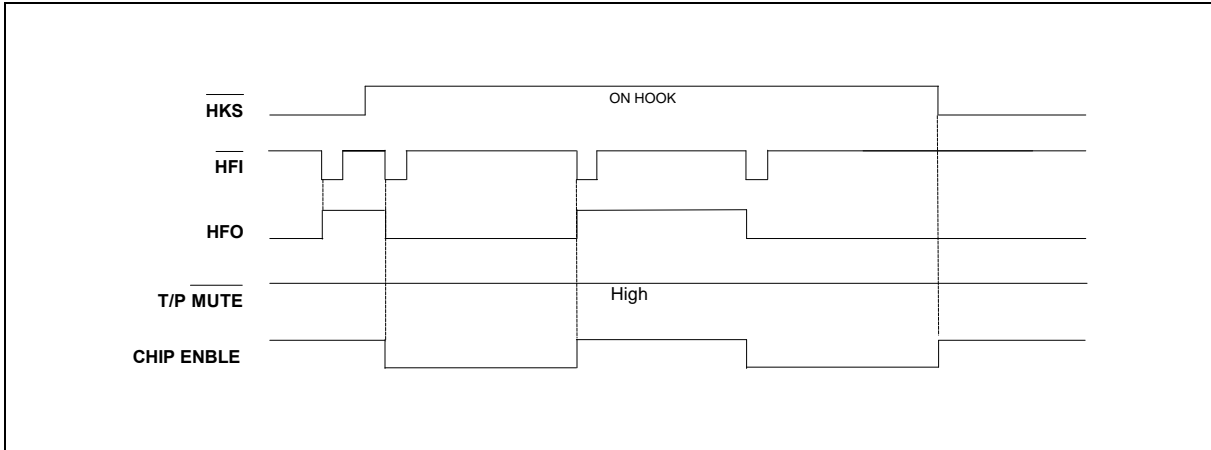

Figure 3. Handfree Timing diagram

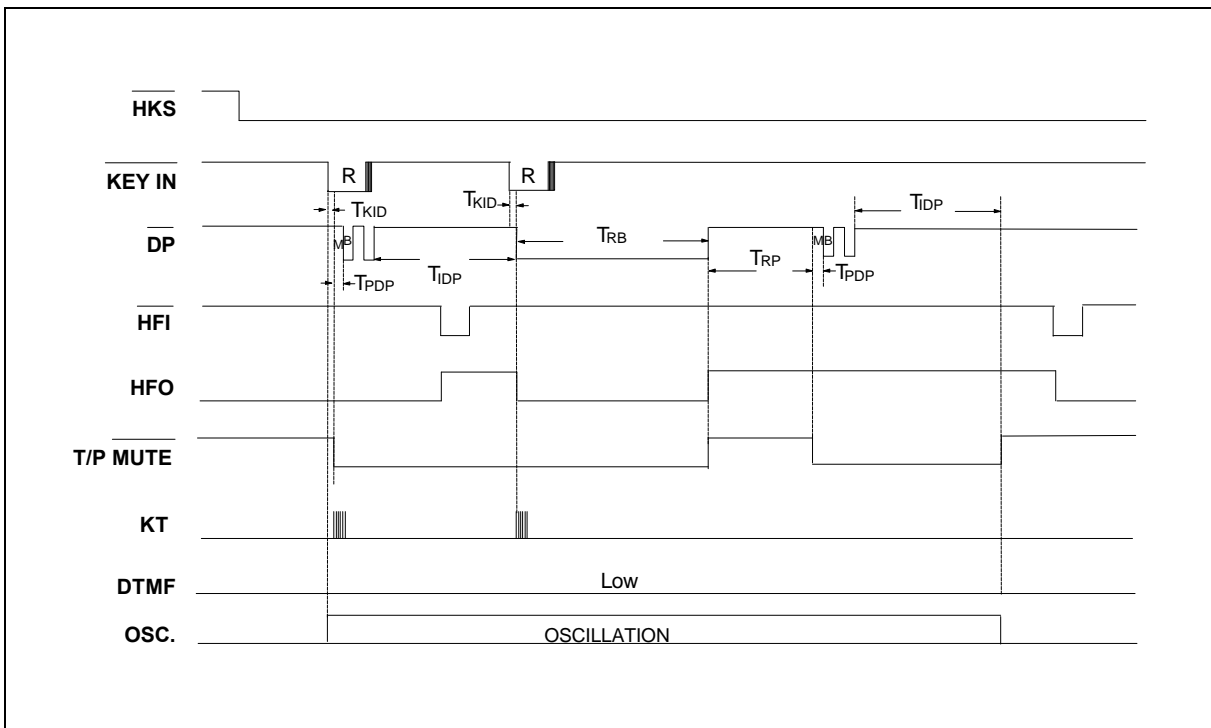

Figure 4. One-key Redial Timing Diagram

# W91510N SERIES



Timing Waveform, continued

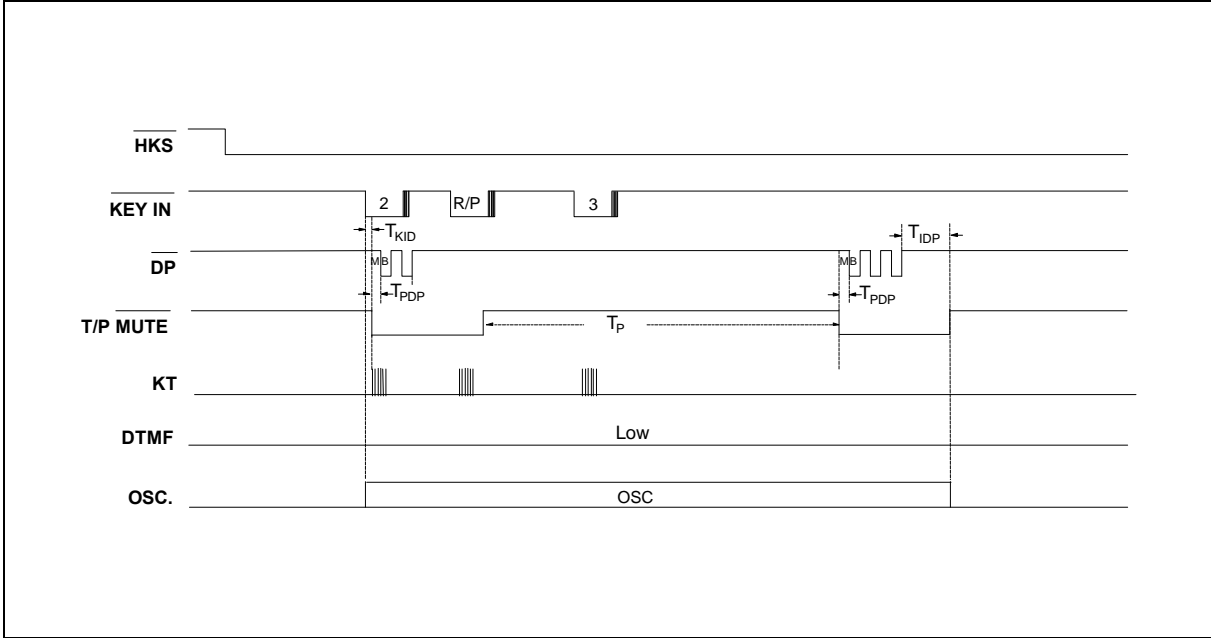

Figure 5. Pause Function Timing Diagram

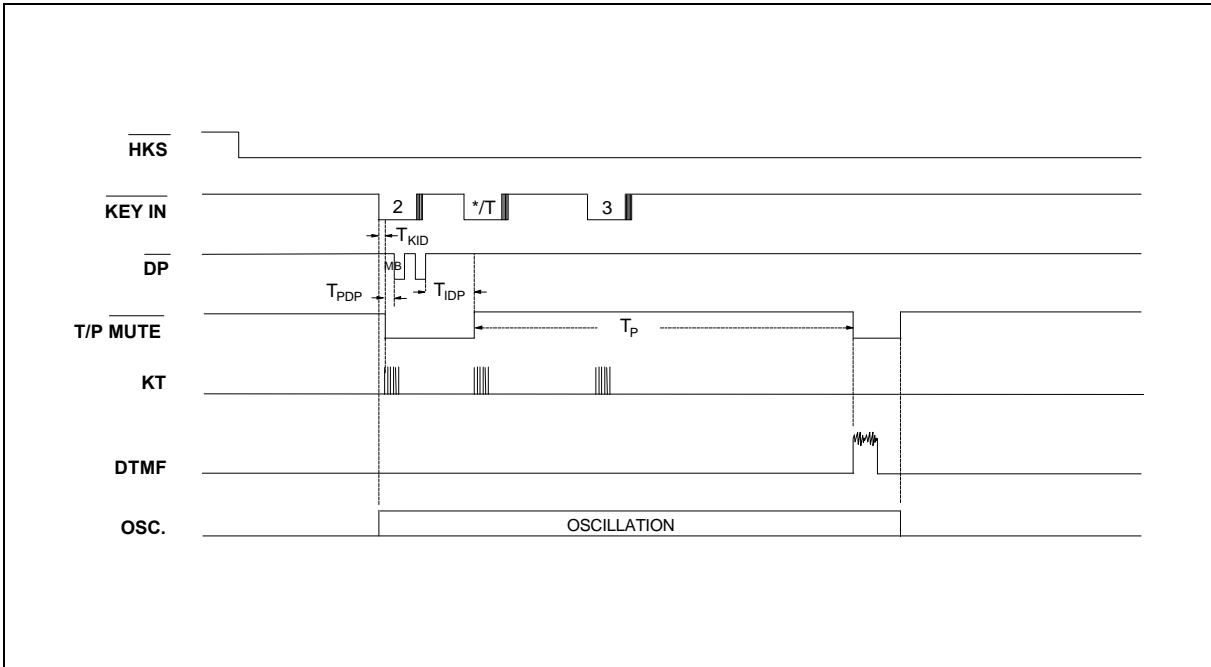

Figure 6. Pulse-to-tone Timing Diagram

# W91510N SERIES



Timing Waveform, continued

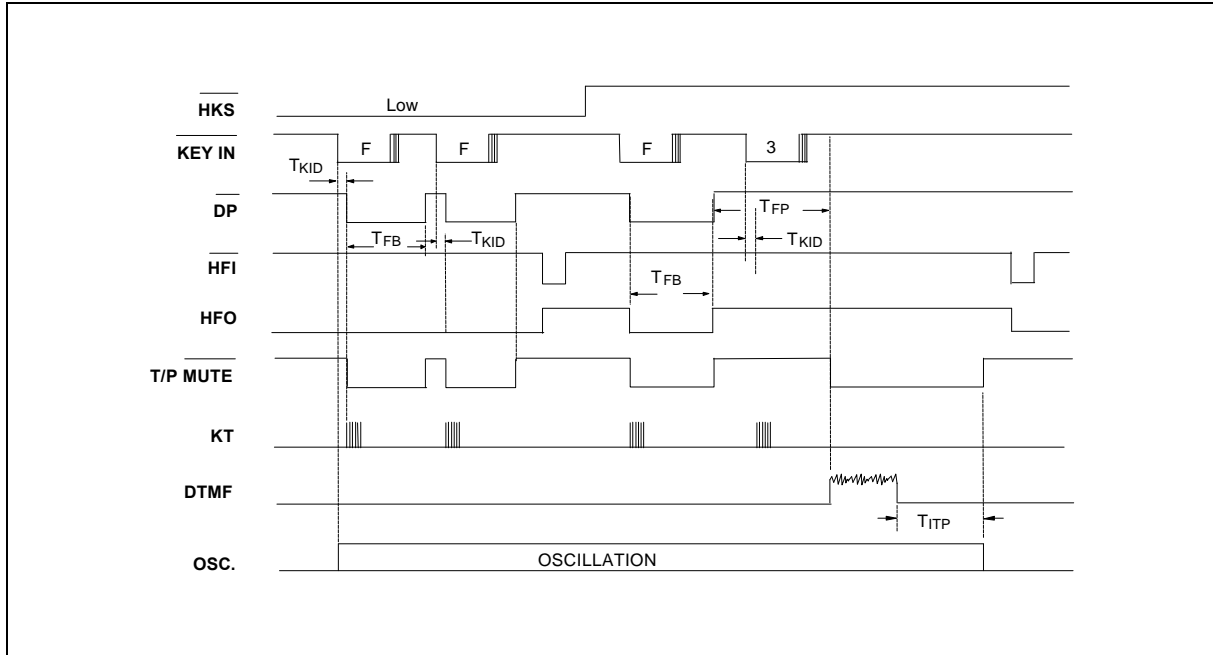

Figure 7. Flash Timing Diagram

# W91510N SERIES



#### Headquarters

No. 4, Creation Rd. III,  
Science-Based Industrial Park,  
Hsinchu, Taiwan  
TEL: 886-3-5770066  
FAX: 886-3-5792697  
<http://www.winbond.com.tw/>  
Voice & Fax-on-demand: 886-2-7197006

#### Taipei Office

11F, No. 115, Sec. 3, Min-Sheng East Rd.,  
Taipei, Taiwan  
TEL: 886-2-7190505  
FAX: 886-2-7197502

#### Winbond Electronics (H.K.) Ltd.

Rm. 803, World Trade Square, Tower II,  
123 Hoi Bun Rd., Kwun Tong,  
Kowloon, Hong Kong  
TEL: 852-27516023  
FAX: 852-27552064

#### Winbond Electronics North America Corp.

Winbond Memory Lab.  
Winbond Microelectronics Corp.  
Winbond Systems Lab.  
2730 Orchard Parkway, San Jose,  
CA 95134, U.S.A.  
TEL: 1-408-9436666  
FAX: 1-408-9436668

---

Note: All data and specifications are subject to change without notice.